



Svetelné zdroje

27-55

Vstavané svietidlá

56-89

Interierová svietidlá

90-120

Svietidlá priemyslové

120-170

Istiaca technika

171-184

Elektroinštalačný materiál

185-207

Náhradné diely

208-221

w w w . k a n l u x . s k



**Kanlux**



## Kanlux S.A.

### 20 rokov spoločnosti Kanlux na trhu

Kanlux S.A. je jeden z najväčších a najstarších poľských podnikov v oblasti osvetlenia. Dňa 1. apríla roku 2009 firma oslávila dvaciate výročie prevádzky hospodárskej činnosti. Výrobky Kanlux sú na území Poľska dodávané zákazníkom prostredníctvom skeve zorganizovanej distribučnej siete, podporované prácou regionálnych manažérov a obchodných predstaviteľov. Produkty ponúkané firmou Kanlux S.A. sú behom jedného roka objednané viac ako 3.000 hospodárskymi subjektami.

### Obchodná ponuka Kanlux

Aby sme boli schopní vyhovieť požiadavkám zákazníkov, Kanlux S.A. neustále rozširuje svoju obchodnú ponuku, majúc na zreteli, aby bola prispôsobená hlavným trendom na trhu. V minulom roku bola uvedená do predaja bohatá ponuka svetelných zdrojov využívajúcich ako zdroj svetla LED diódy. Dnes obchodná ponuka Kanlux S.A. obsahuje viac ako 1300 položiek tovaru, medzi ktoré patria svetelné zdroje, podhľadové svietidlá, dekoratívne svietidlá, priemyslové svietidlá, ističia technika a elektroinštalačný materiál.

### Kanlux vo svete

Výrobky značky Kanlux sú známe nielen v Poľsku. Kanlux S.A. má svoje spoločnosti v Českej republike, na Slovensku a v Maďarsku. Naviac distribuuje svoje výrobky na trhoch vo Francúzku, Nemecku, Rakúsku, Holandsku, Švédsku, Dánsku, Ukrajine, Rusku, Bielorusku, Moldavsku, Litve, Lotyšsku, Estónsku, Fínsku, Bulharsku, Rumunsku, Slovinsku a Čiernej Hore. Tovar so značkou Kanlux sa vďaka stálemu udržiavaniu vysokej kvality svojich výrobkov a prístupnej cene teší veľkému úspechu takmer v celej Európe.

### Sídlo, kvalita a ľudský kapitál

Sídlo Kanlux S.A sa nachádza v Sliezsku. Moderná kancelárska budova a sklady vysokého skladovania, ktoré sú vlastníctvom podniku, sa nachádzajú na pozemku o rozlohe viac ako 2 ha.

Kanlux S.A. už roky pracuje podľa najvyšších svetových štandardov, o čom svedčí v roku 2004 firmou získaný certifikát ISO. Kanlux S.A. získal ocenenie v mnohých súťažiach a rebríčkoch, ako napr. Solidna Firma, Gazela Biznesu alebo Firma Primus Inter Pares. Spoločnosť osemkrát za sebou získava titul Firmy Fair Play. Najväčším kapitálom Kanlux S.A. sú však ľudia. Podnik zamestnáva skoro 150 osôb a investuje do ich rozvoja tým, že organizuje tematicky rôznorodé školenia. Vysoká kvalifikácia zamestnancov a ich angažovanosť majú zásluhu na tom, že Kanlux S.A. sa stále dynamicky rozvíja a je neustále jedným z lídrov v odbore elektrotechniky a osvetlenia.





 28 LUCA LED48 E14-WW	 28 LUCA LED48 E27-WW	 28 KALI LED36 E27-WW	 29 LAB LED30 E14-WW	 29 LAB LED30 E27-WW	 29 JUTA LED30 E14-WW
 29 JUTA LED30 E27-WW	 30 ODA LED12 E27-WW	 30 ODA LED12 E27-Y	 30 ODA LED12 E27-GN	 30 ODA LED12 E27-BL	 30 ODA LED12 E27-RE
 30 REA LED12 E14-WW	 30 REA LED12 E14-Y	 30 REA LED12 E14-GN	 30 REA LED12 E14-BL	 30 REA LED12 E14-RE	 31 LED60 E14
 31 LED60 E27	 31 POWER-LED MR16	 32 POWER-3LED MR16	 32 LED48 MR16	 33 LED60 MR16	 33 LED20 MR16-CW
 33 LED20 MR16-WW	 33 LED20 MR16-Y	 33 LED20 MR16-GN	 33 LED20 MR16-BL	 33 LED20 MR16-RE	 34 POWER-LED GU10
 34 POWER-3LED GU10	 35 LED48 GU10	 35 LED60 GU10	 36 LED12 GU10-CW	 36 LED20 GU10	 36 LED20 GU10-Y
 36 LED20 GU10-GN	 36 LED20 GU10-BL	 36 LED20 GU10-RE	 37 SUPERSHAPE BH4-9X E14/K	 37 SUPERSHAPE BH4-9X E27/K	 37 SUPERSHAPE BH4-11X E14/K





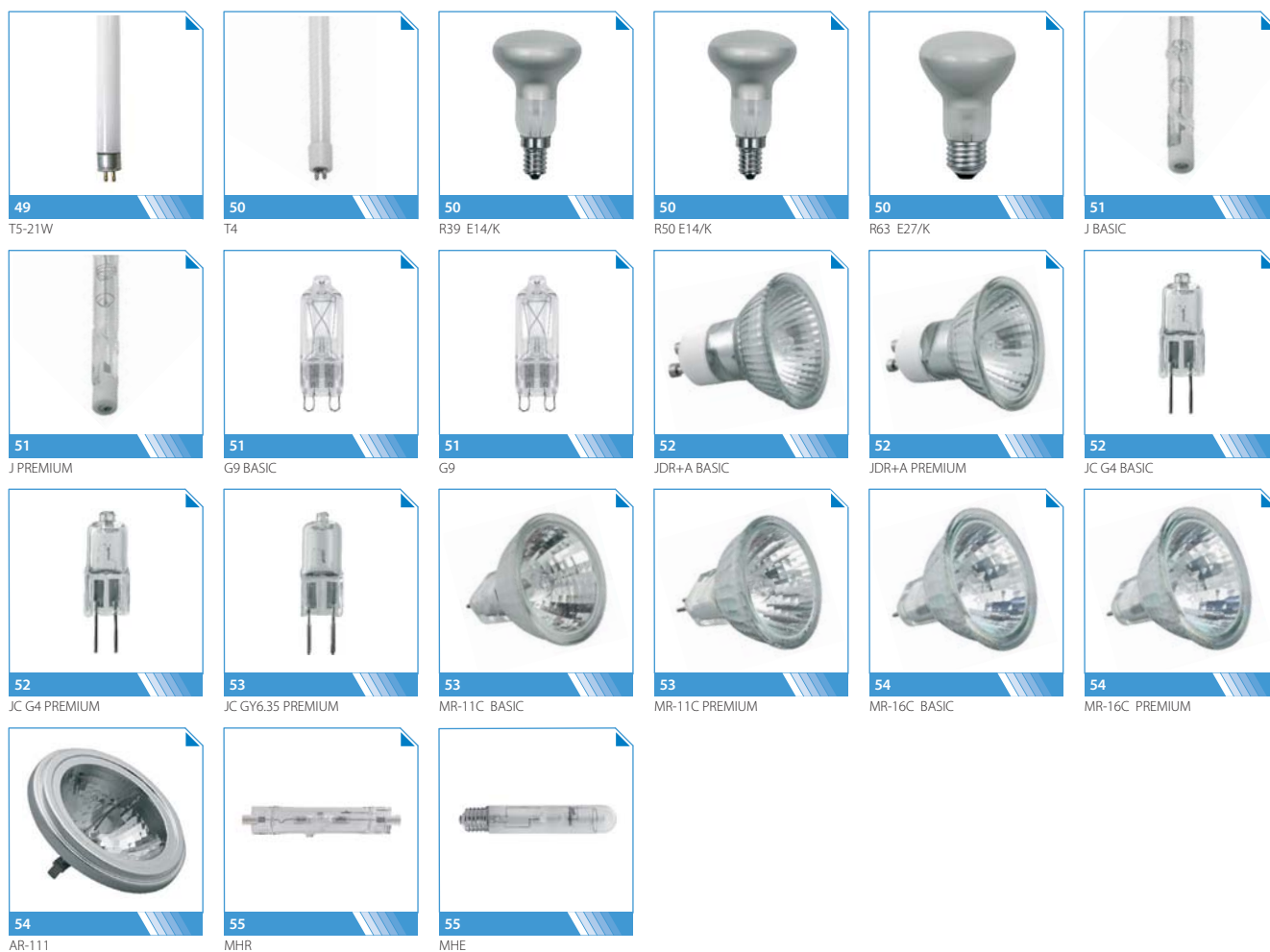









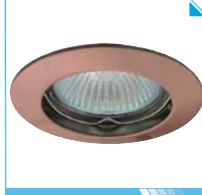







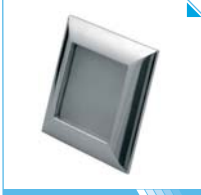















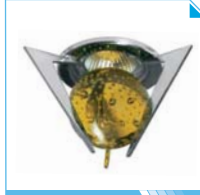

## Svetelné zdroje

 37 SUPERSHAPE BH4-11X E27/K	 37 SUPERSHAPE BH4 E27/K	 37 SUPERSHAPE BH5-24W E27/K	 38 SPIRAL ETU-MSS 7W E14/K	 38 SPIRAL ETU-MSS E27/K	 38 SPIRAL ETU-SS 24W E27/K
 38 SENSORSPIRAL ETU-CSS E27/K	 39 2U XEU E14	 39 2U XEU E27	 39 3U XEU E14	 39 3U XEU E27	 40 2U SLIM XEU23-7W E14/K
 40 3U SLIM XEU23 E14/K	 40 SUPERSLIM ETU-M E27/K	 41 4U MINI XEU48 E14/K	 41 4U XEU48 E27/K	 42 FON CDL-7W E14	 42 FON CDL-7W E27
 42 FON CDL-9W E14	 42 FON CDL-9W E27	 42 FON GBL-11W E27	 42 DART CDL-7 E14/K	 42 DART CDL-11S E27/K	 43 DAO GBL-7W E14
 43 DAO GBL-7W E27	 43 DAO QDL-7W E14	 43 DAO QDL E27	 44 MINIGLOB XEU48 E14/K	 44 GLOB XEU48 E27/K	 45 SUPERGLOB XEU23-15G1 E27/K
 45 SUPERGLOB XEU38-20G E27/K	 45 BALTA-24W 118MM	 46 CDL GU10	 46 ESG-75 9W GX53	 47 FCL-22W/4P 2700K	 47 DD 2P
 47 DD 4P	 48 T1U	 48 T2U	 49 T5-8W	 49 T5-13W	 49 T5-14W























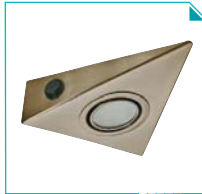

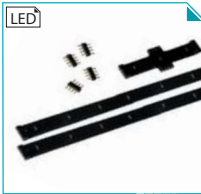



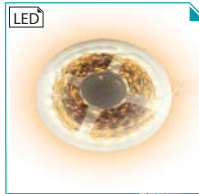













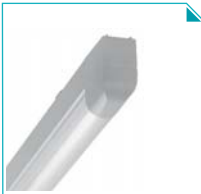

## Vstavané svetidlá

 62 RADAN CT-DT050	 62 RADAN CT-DTL50	 62 LUTO CTX-DS02B	 63 LUTO CTX-DT02B	 63 VIDI CTC-5514	 64 VIDI CTC-5515
 64 BASK CTC-5514	 65 BASK CTC-5515	 65 RODOS CT-DS09	 66 RODOS CT-DT09	 66 NAVI CTX-DS10	 67 NAVI CTX-DT10
 67 TOSA CT-DS87-SN	 68 RESO CTX-KW10	 68 NOMA CTX-DS10G	 69 DINO CTX-DS02G	 69 RONA CT-AS11-AL	 70 TABO CT-AS02-AL
 70 AKRA CT-DS14	 71 DAVID CTX-20-SN	 71 RUBIX CTX-40+D-C	 71 RUBIX CTX-40+B3-SN/N	 72 GAVEL CTX-20+B1-SN/G	 72 GAVEL CTX-20+B2-SN/N
 72 GAVEL CTX-20+D-MPC/N	 72 MIKA CTX-42+D-MPC/N	 72 MIKA CTX-42+B2-SN/N	 73 EDYP CTX-40+P	 73 DANTE CTX-41+D-C	 74 TRISTAN CTX-10
 74 IGLO CTX-30+G-C/M	 74 IGLO CTX-30+SQ-C/M	 75 PERS CT-DS94-C/W	 75 MARIN CT-S80	 76 QULES CT-DS83-SN	 76 GLEN CT-DS82
 77 VELO CT-AS83-AL	 77 DELE AL-204	 78 DELE AL-205	 78 TESON AL-DS050	 78 TESON AL-DSL50	 79 TESON AL-DT050



## Interierová svietidlá

 96 SAXO LED KT-58	 97 CARI LED18 KT-87	 97 EBOS LED12/JC	 98 KREON TL-GX53	 98 FAUST DL	 98 FAUST KT-455
 99 SALUT DL-305-S	 99 SALUT DL-307-S	 100 SALUT DL-138RA/1	 100 ZEPO LFD-T02	 100 ZEPO LFD-T02/S	 101 LINEAL 3LED12
 101 TETRIS LED15	 101 TETRIS 2LED15	 102 VOLCANO LED-WW 5M	 102 VOLCANO LED-CW 5M	 102 VOLCANO LED-Y 5M	 102 VOLCANO LED-OR 5M
 102 VOLCANO LED-GN 5M	 102 VOLCANO LED-BL 5M	 102 VOLCANO LED-RE 5M	 102 ISTRO LED-WW 5M	 102 ISTRO LED-CW 5M	 102 ISTRO LED-Y 5M
 102 ISTRO LED-OR 5M	 102 ISTRO LED-GN 5M	 102 ISTRO LED-BL 5M	 102 ISTRO LED-RE 5M	 103 GRELA TL2004B	 103 GRELA TL2004C
 104 MERA TL	 104 GLORIA TL3011	 105 PAX TL2016B	 105 CERES TL2014-13W-SR	 106 CELT TL2050-13W-SR	 106 EVAN TL
 107 MIG LED-40	 107 MIG LED-4L	 107 ZENA EL-2	 107 ZENA EL-4	 108 VANTI EL-440	 108 LEVEL EL-150L





109  
AMY EL-140



109  
AMY EL-T240



109  
AMY EL-U240



109  
TOMA EL-10



109  
TOMA EL-21



109  
TOMA EL-31



109  
TOMA EL-30



109  
TOMA EL-41



110  
ANO 10



110  
ANO 21



110  
ANO 31



110  
ANO 41



110  
HALI 10

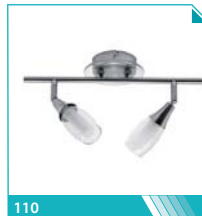

110  
HALI 21



110  
HALI 31



110  
HALI 30



110  
HALI 41



111  
GINA EL-1L



111  
GINA EL-21



111  
GINA EL-31



111  
GINA EL-3L



111  
GINA EL-41



111  
MOLI EL-10



111  
MOLI EL-21



111  
MOLI EL-30

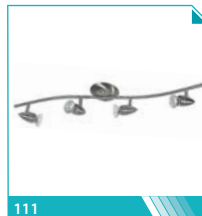

111  
MOLI EL-41



112  
SONDA EL-1L



112  
SONDA EL-2J



112  
SONDA EL-3J



112  
SONDA EL-4L



112  
ARDEA 1030 1/2/ML-BI



112  
ARDEA 1030 / 1130



113  
ARDEA 1030 1/2G/ML-SR



113  
ARDEA 1030 / 1130



113  
TIVA 1030 1/2DR/ML-SN



113  
TIVA 1030 / 1130



114  
TIVA 1030 1/2DR/ML-DB



114  
TIVA 1030 / 1130



114  
TIVA 1030 1/2DR/ML-MH



114  
TIVA 1030 / 1130



115  
TIVA 1030 1/2DR/ML-OL



115  
TIVA 1030 / 1130

## Interierová svietidlá



115  
SLENI 1030 / 1130



116  
VERA LED EL-18L-UP



116  
VERA LED EL-22I-UP



116  
VERA LED EL



116  
SORIN LED EL-21L-UP



116  
SORIN LED EL-32I-UP



116  
SORIN LED EL



117  
EDEN EL-25



117  
ALTIMA EL-24L-UP



117  
ALTIMA EL



118  
AKVEN EL-35-GN



118  
MOSKITO T5



119  
SOLO TOE10-230V



119  
KODI NL4636-WHITE



119  
IKER NL4631-WHITE



120  
CRESSIDA NB 40-W



## Svietidlá priemyslové



121  
REGIS 418 PT



122  
VOLKER 418 PT



123  
GRAF 414 PT-EVG



124  
XEDOS 414 NT-EVG



125  
NOTUS 218 NT



125  
NOTUS 236 NT



125  
NOTUS 418 NT



126  
TOKEN 236 NT



126  
TOKEN 418 NT



127  
ALDO 118 / 136 / 158



127  
ALDO 218 / 236 / 258



127  
MEBA TL-218



127  
MEBA TL-218/OP



127  
MEBA TL-236



127  
MEBA TL-236/OP



128  
OFRA TL-218A-SR



128  
OFRA TL-218A-W



128  
OFRA TL-236A-SR



 128 OFRA TL-236A-W	 128 OFRA TL-218B-SR	 128 OFRA TL-218B-W	 128 OFRA TL-236B-SR	 128 OFRA TL-236B-W	 129 MAH-A
 130 MAH-A	 131 MAH-A-PS	 132 MAH-A-PS	 133 VOLIN EL-9	 133 PORTOS 11	 134 LUVEN MX
 134 VISTO DL	 135 VIGA DL-280	 135 VIGA DL-28L	 135 IVO DL-380	 135 IVO DL-38L	 136 MARC DL-60
 136 FAVOR DL-60	 137 7070T	 137 TUNA S1101-W	 138 KIRA DL	 138 INES 7061NC	 138 INES 7061N
 139 MILO 7040T	 139 MILO 7040T/P	 139 HERMI 7063NB	 140 TURK DL-60	 140 FRODO DL-60	 141 SHARK EL-60
 141 VITAM EL-60	 142 BART EL	 142 ZEW EL-235J	 142 ZEW EL-235U	 LED 143 DORA LED-J01	 LED 143 LINDA LED-J02
 LED 143 ALAN LED-J03	 LED 143 ALAN LED-J04	 LED 143 LICA LED-J04A	 LED 144 KONRAT DL-LED 24A	 LED 144 KONRAT DL-LED 24B	 LED 144 TAXI LED9KW

Svietidlá priemyslové

 144 TAXI LED12PR	 145 ROGER DL-2LED6	 145 ROGER DL-LED12	 145 GORDO DL-LED14	 145 GORDO DL-LED14L	 146 MORO DL-35
 146 BERG DL-350	 146 BERG DL-35L	 147 XARD DL-40	 147 TURO MTH	 148 NIKOR DLP	 148 MAYOR DLP-226-W
 149 RALF DL-220-W	 149 VARIO DL-220-W	 150 BEN DL-220-W	 150 ASTON DLP-100	 151 SLOT DLP-100G	 151 NAZAR DLP-200 226-WH
 152 ANDES DLP-300G 226-WH	 152 MATEO DLP-150-GR	 152 MATEO DLP-250-GR	 152 MATEO DLP-350-GR	 152 MATEO DLP-450-GR	 153 SELVA MTH-150-W
 153 BRAVA MTH	 154 PASAT	 154 MEDIA MTH 70W	 154 MEDIA MTH 150W	 155 ESPERO MTH-1150-GR	 155 ESPERO MTH-2150-GR
 155 ESPERO MTH-3150-GR	 155 ESPERO MTH-4150-GR	 155 EURO MTH 16PC	 155 EURO MTH 22PC	 156 EURO MTH 21AL	 156 ENEA EL-17A-SR
 157 ENEA PR	 157 ENEA TR	 158 MATMA MTH	 158 REVA MTH /S	 159 REVA MTH /A	 159 FORT MTH-473/ B



## Istiaca technika



## Elektroinštalačný materiál





					
189 WIR ZL100	189 TEMA DX-3F	189 TEMA DX-5F	190 TEMA DX-3FS	190 TEMA DX-5FS	190 FINAR DX-02-Y 1.0
					
191 MIZAK DX-02-Y 1.5	191 MANGO KF-FBG	192 LIGO DX-3G1.0MM2	192 LIGO DX-3G1.5MM2	192 ZARK KRT/2-1	192 ZARK KRW-3
					
193 DAN KGP-1	193 PIN W/US	194 STAN GP	194 GRIP W/US	195 ADI 65	195 RICO LED
					
196 TRET0 LED	196 SET ULTRA SLIM	197 SET	197 OTON RT	198 BL EVG	198 MB
					
199 GANA	199 PERU	200 GB-2x26W	200 B5	201 MERGE JQ-L	201 MERGE JQ-O
					
202 ALER JQ-30	202 ZONA JQ-37-W	203 DOMI EB230-W	203 DOMI EB3-W	203 ELMA 6898-80	203 ELMA 6898-81
					
204 CYBERTM-6	204 STER TS-MF1	205 ROLO JQ-O	205 ROLO JQ-L	205 IT-1/10	205 IT-1/20

## Elektroinštalačný materiál



206  
PC



206  
H PP



207  
HLDR-E14



207  
HLDR-E27



207  
HLDR-E27-F



207  
HLDR-E27-D



207  
HLDR-GZ10



207  
HLDR-R7S



207  
HLDR-GX5.3



## Náhradné diely

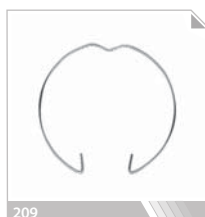

209  
SPRCT



210  
MERA PP



210  
CONNECT TL2004B-PP



210  
GL-HALI/CL+FR



210  
GL-ANO/CL+FR



211  
GL-GINA EL



211  
GL-AMY EL



211  
GL-EDEN



211  
FSL F4 T5/BL



212  
CLP-REGIS/PT

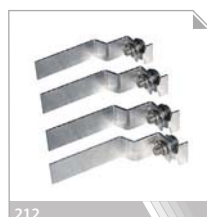

212  
CLP-VOLKER/PT



212  
ROPE-NT 150



212  
COV-MEBA TL



213  
GL-MEBA TL-218/OP



213  
GL-MEBA TL-218/PMMA



213  
GL-MEBA TL-236/OP



213  
GL-MEBA TL-236/PMMA



214  
CL-MAH/A



427  
CL-MAH/A-INOX



214  
GL-MAH-1118/A



215  
GL-MAH-1136/A



215  
GL-MAH-1158/A



216  
GL-MAH-1218/A



216  
GL-MAH-1236/A



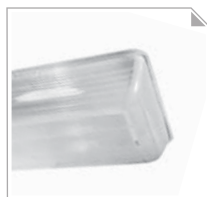

217  
GL-MAH-1258/A



217  
GL-S1101-W



217  
GL-PASAT



218  
GL-MATMA 70/150



218  
GL-MTH-473/150W



218  
GL-MTH-478/400W



219  
GL-ADAMO 250/400



219  
GLASS-LOMA



219  
GLASS-SALI



219  
GLASS-CE



220  
GLASS-SL



221  
GLASS-ZW3-L150

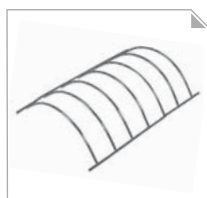

221  
GRID-ZW3-L

A - Z

3 - B

Abecedný index

Model	Kód	Strana
3U XEU-15W E14	07642	39
3U XEU-18W E27	07643	39
3U XEU-20W E27	07644	39
3U XEU-24W E27	07645	39
3U XEU-9W E14	07640	39
4U MINI XEU48-11X E14/K	12698	41
4U MINI XEU48-9X E14/K	12697	41
4U XEU48-11U E27/K	10681	41
4U XEU48-13U E27/K	10682	41
4U XEU48-15U E27/K	10683	41
4U XEU48-18U E27/K	10684	41
4U XEU48-20U E27/K	10685	41
4U XEU48-9U E27/K	10680	41
7070T	70527	137
ADAMO MTH-250/A	04845	161
ADAMO MTH-250/S	04841	160
ADAMO MTH-400/A	04846	161
ADAMO MTH-400/S	04842	160
ADI 65	01440	195
AKRA CT-DS14PS/N	04785	70
AKRA CT-DS14SN/G	04786	70
AKVEN EL-35-GN	07140	118
ALAN LED-J03	04682	143
ALAN LED-J04	04683	143
ALDO 118	04600	127
ALDO 136	04602	127
ALDO 158	04604	127
ALDO 218	04601	127
ALDO 236	04603	127
ALDO 258	04605	127
ALER JQ-30-B	00461	202
ALER JQ-30-W	00460	202

Model	Kód	Strana
ALTER CTX-50+04-AB	02899	85
ALTER CTX-50+04-C/M	02897	85
ALTIMA EL-110	07512	117
ALTIMA EL-24L-UP	07510	117
ALTIMA EL-45	07511	117
AMY EL-I40	07130	109
AMY EL-T240	07131	109
AMY EL-U240	07132	109
ANDES DLP-300G 226-WH	04361	152
ANO 10	04720	110
ANO 2I	04721	110
ANO 3I	04722	110
ANO 4I	04723	110
AR-111 35W45	10852	54
AR-111 50W45	10857	54
ARDEA 1030 1/2/ML-BI	70788	112
ARDEA 1030 1/2G/ML-SR	70771	113
ARDEA 1030 M/ML-BI	70786	112
ARDEA 1030 MG/ML-SR	70766	113
ARDEA 1030 S/ML-BI	70784	112
ARDEA 1030 SG/ML-SR	70761	113
ARDEA 1130 D/ML-BI	70782	112
ARDEA 1130 DG/ML-SR	70756	113
ARGUS CT-2114-AN	00327	58
ARGUS CT-2114-BR/M	00324	58
ARGUS CT-2114-C	00301	58
ARGUS CT-2114-C/M	00325	58
ARGUS CT-2114-G	00300	58
ARGUS CT-2114-GM	00328	58
ARGUS CT-2114-W	00303	58
ARGUS CT-2115-AN	00333	58
ARGUS CT-2115-BR/M	00330	58

Model	Kód	Strana
ARGUS CT-2115-C	00305	58
ARGUS CT-2115-C/M	00331	58
ARGUS CT-2115-G	00304	58
ARGUS CT-2115-GM	00334	58
ARGUS CT-2115-W	00307	58
ARGUS CT-2115-YG	00335	58
ARGUS CT-2117-AN	00339	59
ARGUS CT-2117-BR/M	00336	59
ARGUS CT-2117-C	00309	59
ARGUS CT-2117-C/M	00337	59
ARGUS CT-2117-G	00308	59
ARGUS CT-2117-GM	00340	59
ARGUS CT-2117-W	00311	59
ASTON DLP-100 218-WH	04340	150
ASTON DLP-100 226-WH	04341	150
AVIA MTH-478/250W-B	04013	160
AVIA MTH-478/400W-B	04011	160
BALTA -24W 118MM	07450	45
BART EL-135	07079	142
BART EL-140	07083	142
BART EL-160	07081	142
BART EL-235	07080	142
BART EL-260	07082	142
BASK CTC-5514-MPC/N	02814	64
BASK CTC-5514-PG/N	02810	64
BASK CTC-5514-SG/N	02815	64
BASK CTC-5514-SN/G	02813	64
BASK CTC-5514-SN/N	02816	64
BASK CTC-5515-MPC/N	02804	65
BASK CTC-5515-PG/N	02800	65
BASK CTC-5515-SG/N	02805	65
BASK CTC-5515-SN/G	02803	65

Model	Kód	Strana
BASK CTC-5515-SN/N	02806	65
BBU12/1	02155	180
BBU12/3	02156	181
BBU54/3	02158	181
BBU56/1	02157	180
BEN DL-220-W	04822	150
BERG DL-35L	07171	146
BERG DL-350	07170	146
BL-118H-EVG	70480	198
BL-136H-EVG	70481	198
BL-158H-EVG	70482	198
BL-218H-EVG	70483	198
BL-236H-EVG	70484	198
BL-258H-EVG	70485	198
BONI DL-RD50-PG/N	04921	81
BONI DL-RD50-PS/G	04920	81
BONI DL-RD50-SN/G	04922	81
BONI DL-RD50-SN/N	04923	81
BRAS KT-18-SR	07160	94
BRAVA MTH-150-W	04901	153
BRAVA MTH-70-W	04900	153
BRUNO EL-13-B	07215	162
BS-1 4-22W	07180	200
BS-2 4-65W	07181	200
BT-8 8/12/24V	03806	179
CARI LED18 KT-87	07760	97
CDL-7W GU10	12731	46
CDL-9W GU10	12732	46
CEL CTC-5519-C/M	02755	60
CELT TL2050-13W-SR	04872	106
CERES TL2014-13W-SR	04280	105
CL-MAH/A	72304	214
CL-MAH/A-INOX	72308	214
CLP-REGIS/PT	72333	212
CLP-VOLKER/PT	72383	212
CONECT TL2004B-PP	00525	210
COV-MEBA TL	72398	212
CRESSIDA NB40-W	07920	120
CYBER TM-6	01016	204
CYKLON EOL100	70910	187
CYKLON EOL100B	70911	187
CYKLON EOL100HT	70936	187
CYKLON EOL100P	70937	187
CYKLON EOL100T	70938	187
CYKLON EOL120	70915	187
CYKLON EOL120B	70916	187
CYKLON EOL120HT	70941	187
CYKLON EOL120P	70942	187
CYKLON EOL120T	70943	187
CYKLON EOL150	70920	188
CYKLON EOL150B	70921	188
CYKLON EOL150P	70947	188
CYKLON EOL150T	70948	188
DAN KGP-1	02185	193
DANTE CTX-41+D-C	02871	73
DAO GBL-7W E14	07791	43
DAO GBL-7W E27	07790	43
DAO QDL-11W E27	07780	43
DAO QDL-7W E14	07771	43
DAO QDL-7W E27	07770	43
DART CDL-11S E27/K	10640	42
DART CDL-7 E14/K	10641	42
DAVID CTX-20-SN	04965	71
DB102W 1X2P/SM	03850	184
DB104F 1X4P/FMD	03840	182
DB104S 1X4P/SMD	03830	183
DB104W 1X4P/SM	03851	184
DB106F 1X6P/FMD	03841	182
DB106S 1X6P/SMD	03831	183
DB108F 1X8P/FMD	03842	182

Model	Kód	Strana
DB108S 1X8P/SMD	03832	183
DB108W 1X8P/SM	03852	184
DB112F 1X12P/FMD	03843	182
DB112S 1X12P/SMD	03833	183
DB112W 1X12P/SM	03853	184
DB118F 1X18P/FMD	03844	182
DB118S 1X18P/SMD	03834	183
DB118W 1X18P/SM	03854	184
DB212F 2X12P/FMD	03845	183
DB212S 2X12P/SMD	03835	184
DB312F 3X12P/FMD	03846	183
DB312S 3X12P/SMD	03836	184
DD-16W/2P 3500K	12650	47
DD-16W/4P 3500K	12660	47
DD-21W/4P 3500K	12661	47
DD-28W/4P 3500K	12662	47
DD-38W/4P 3500K	12663	47
DELE AL-204-C	00911	77
DELE AL-204-C/M	00913	77
DELE AL-205-C	00921	78
DELE AL-205-C/M	00923	78
DINO CTX-DS02G/A-C	02571	69
DINO CTX-DS02G/B-C	02576	69
DOMI EB230-W	07882	203
DOMI EB3-W	07881	203
DORA LED-J01	04680	143
EB230 230V	03805	179
EBOS LED12/JC	07600	97
EDEEN EL-25	04945	117
EDIT SL-300R-F-B	00685	166
EDIT SL-300R-F-W	00686	166
EDIT SL-300R-P-B	00687	169
EDIT SL-300R-P-W	00688	169
EDYP CTX-40+P-C	02860	73
EDYP CTX-40+P-SN/N	02861	73
ELIOT ZW3-L500P-B	00620	170
ELMA 6898-80	00506	203
ELMA 6898-81	00505	203
ELSE CT-2116C-C	00821	84
ELSE CT-2116C-C/M	00825	84
ELSE CT-2116C-G	00823	84
ENEAL EL-17A-SR	07530	156
ENEAL PR	07533	157
ENEAL TR 1M	07531	157
ENEAL TR 2M	07532	157
ESG-75 9W GX53	07430	46
ESPERO MTH-1150-GR	07490	155
ESPERO MTH-2150-GR	07491	155
ESPERO MTH-3150-GR	07492	155
ESPERO MTH-4150-GR	07493	155
EURO MTH-250-16PC	07860	155
EURO MTH-250-21AL	07864	156
EURO MTH-250-22PC	07862	155
EURO MTH-400-16PC	07861	155
EURO MTH-400-21AL	07865	156
EURO MTH-400-22PC	07863	155
EVAN TL-13	00536	106
EVAN TL-8	00535	106
FARE SL-150R-F-B	00680	166
FARE SL-150R-F-W	00681	166
FARE SL-150R-P-B	00682	169
FARE SL-150R-P-W	00683	169
FAUST DL-260	07421	98
FAUST DL-480	07422	98
FAUST KT-455	07420	98
FAVOR DL-60	07020	136
FCL-22W/4P 2700K	12670	47
FERRA DL-3POWER LED	07351	89
FINAR DX-02-Y 1.0 3M	02020	190
FINAR DX-02-Y 1.0 5M	02021	190

Model	Kód	Strana
FON CDL-7W E14	12840	42
FON CDL-7W E27	12842	42
FON CDL-9W E14	12841	42
FON CDL-9W E27	12843	42
FON GBL-11W E27	12850	42
FORT MTH-473/150W-B	04010	159
FORT MTH-473/70W-B	04012	159
FRODO DL-60	07340	140
FSL F4 T5/BL	72359	211
G9-25W	10870	51
G9-25W/EK BASIC	12700	51
G9-40W	10871	51
G9-40W/EK BASIC	12701	51
G9-60W	10872	51
G9-60W/EK BASIC	12702	51
GANAL 150	07272	199
GANAL 35	07270	199
GANAL 70	07271	199
GAVEL CTX-20+B1-SN/G	02882	72
GAVEL CTX-20+B2-SN/N	02881	72
GAVEL CTX-20+D-MPC/N	02880	72
GAVI CT-2116B-AN	00817	86
GAVI CT-2116B-BR/M	00814	86
GAVI CT-2116B-C	00811	86
GAVI CT-2116B-C/M	00815	86
GAVI CT-2116B-G	00813	86
GAVI CT-2116B-W	00810	86
GAVI LED-2116B-C/M-27	04265	86
GAVI LED-2116B-C-27	04266	86
GB-2x26W	04376	200
GINAL EL-1L	07110	111
GINAL EL-2I	07111	111
GINAL EL-3I	07112	111
GINAL EL-3L	07113	111
GINAL EL-4I	07114	111
GL-ADAMO 250/400	72372	219
GL-AMY EL	72386	211
GL-AN/O/CL+FR	72351	210
GLASS-CE-81	72159	219
GLASS-CE-81-Y	72160	220
GLASS-CE-82	72163	220
GLASS-CE-82-Y	72164	220
GLASS-LOMA	72187	219
GLASS-SALI	72186	219
GLASS-SL-150R-F	72165	220
GLASS-SL-300R-F	72166	221
GLASS-ZW3-L150	72126	221
GL-EDEN	72382	211
GLEN CT-DS82-AB	04711	76
GLEN CT-DS82-C	04707	76
GL-GINA EL	72393	211
GL-HALI/CL+FR	72352	210
GL-MAH-1118/A-PC	72280	214
GL-MAH-1118/A-PS	72362	214
GL-MAH-1136/A-PC	72281	215
GL-MAH-1136/A-PS	72364	215
GL-MAH-1158/A-PC	72282	215
GL-MAH-1158/A-PS	72366	215
GL-MAH-1218/A-PC	72283	216
GL-MAH-1218/A-PS	72363	216
GL-MAH-1236/A-PC	72284	216
GL-MAH-1236/A-PS	72365	216
GL-MAH-1258/A-PC	72285	217
GL-MAH-1258/A-PS	72367	217
GL-MATMA 70/150	72368	218
GL-MEBA TL-218/OP	72396	213
GL-MEBA TL-218/PMMA	72391	213
GL-MEBA TL-236/OP	72397	213
GL-MEBA TL-236/PMMA	72392	213
GL-MTH-473/150W	72306	218

Model	Kód	Strana
GL-MTH-478/400W	72307	218
GLOB XEU48-11XG E27/K	12691	44
GLOB XEU48-15G E27/K	10615	44
GLOB XEU48-20G E27/K	10616	44
GLOB XEU48-9XG E27/K	12690	44
GLORIA TL3011-18W	00510	104
GLORIA TL3011-30W	00511	104
GL-PASAT 150	72357	218
GL-PASAT 70	72356	217
GL-S1101	72309	217
GOLBA SX065 20W-B	01826	90
GOLBA SX065 20W-B/T	01828	90
GOLBA SX065 20W-BLN/T	01841	90
GOLBA SX065 20W-GF/T	01843	90
GOLBA SX065 20W-GND/T	01842	90
GOLBA SX065 20W-PU/T	01844	90
GOLBA SX065 20W-W	01827	90
GOLBA SX065 20W-W/T	01829	90
GORAN CT-J22 C/M	04679	85
GORAN CT-J22 MGR	04699	85
GORAN POWER LED	07710	87
GORDO DL-LED14	07010	145
GORDO DL-LED14L	07012	145
GRAF 414 PT-EVG	04830	123
GRELA TL2004B-12W	00521	103
GRELA TL2004B-16W	00522	103
GRELA TL2004B-20W	00523	103
GRELA TL2004B-8W	00520	103
GRELA TL2004C-12W-SR	00531	103
GRELA TL2004C-16W-SR	00532	103
GRELA TL2004C-20W-SR	00533	103
GRELA TL2004C-8W-SR	00530	103
GRID-ZW3-L150	72114	221
GRID-ZW3-L500	72115	221
GRIP W/US	04863	194
H-10MM2 PP	02103	206
H-16MM2 PP	02104	206
H-2.5MM2 PP	02100	206
H-4MM2 PP	02101	206
H-6MM2 PP	02102	206
HALI 10	04725	110
HALI 2I	04726	110
HALI 3I	04727	110
HALI 3O	04729	110
HALI 4I	04728	110
HERMI 7063NB	70524	139
HERON KT017C-B	01879	96
HERON KT017C-W	01878	96
HLDR-E14	02170	207
HLDR-E27	02160	207
HLDR-E27-D	02162	207
HLDR-E27-F	02161	207
HLDR-GX5.3	72109	207
HLDR-GZ10	00402	207
HLDR-R75	00405	207
HORN CTC-3114-GM/N	02824	59
HORN CTC-3114-PG/N	02823	59
HORN CTC-3114-PS/G	02822	59
HORN CTC-3114-SN/G	02820	59
HORN CTC-3114-SN/N	02821	59
HORN CTC-3115-GM/N	02834	60
HORN CTC-3115-PG/N	02833	60
HORN CTC-3115-PS/G	02832	60
HORN CTC-3115-SN/G	02830	60
HORN CTC-3115-SN/N	02831	60
IBIS KT028-BL	01886	95
IBIS KT028C-BL	01871	95
IBIS KT028C-GN	01872	95
IBIS KT028C-GR	01873	95
IBIS KT028-GN	01887	95

Model	Kód	Strana
IBIS KT028-GR	01888	95
IBIS KT030-BL	01881	94
IBIS KT030-GN	01882	94
IBIS KT030-GR	01883	94
IGLO CTX-30+G-C/M	02895	74
IGLO CTX-30+SQ-C/M	02896	74
IKER NL4631-WHITE	11163	119
INES 7061N	70525	138
INES 7061NC	70526	138
ISTRO LED-BL 5M	07750	102
ISTRO LED-CW 5M	07751	102
ISTRO LED-GN 5M	07752	102
ISTRO LED-OR 5M	07753	102
ISTRO LED-RE 5M	07754	102
ISTRO LED-WW 5M	07755	102
ISTRO LED-Y 5M	07756	102
IT-1/10-B	01257	205
IT-1/10-BL	01261	205
IT-1/10-GN	01260	205
IT-1/10-RE	01259	205
IT-1/10-W	01262	205
IT-1/10-Y	01258	205
IT-1/10-Y/GN	01263	205
IT-1/20-B	01271	205
IT-1/20-BL	01275	205
IT-1/20-GN	01274	205
IT-1/20-RE	01273	205
IT-1/20-W	01276	205
IT-1/20-Y	01272	205
IT-1/20-Y/GN	01277	205
IVO DL-38L	07311	135
IVO DL-38O	07310	135
J-1000W 189MM PREMIUM	10418	51
J-100W 118MM PREMIUM	10410	51
J-100W 78MM PREMIUM	10400	51
J-100W 78MM/EK BASIC	10700	51
J-1500W 254MM PREMIUM	10419	51
J-150W 118MM PREMIUM	10411	51
J-150W 78MM PREMIUM	10401	51
J-150W 78MM/EK BASIC	10701	51
J-200W 118MM PREMIUM	10412	51
J-200W 118MM/EK BASIC	10712	51
J-300W 118MM PREMIUM	10414	51
J-300W 118MM/EK BASIC	10714	51
J-500W 118MM PREMIUM	10416	51
J-500W 118MM/EK BASIC	10716	51
J-60W 78MM PREMIUM	10404	51
JC-10W G4 PREMIUM	10722	52
JC-10W4/EK BASIC	10432	52
JC-20W G4 PREMIUM	10724	52
JC-20W GY6.35 PREMIUM	10730	53
JC-20W4/EK BASIC	10433	52
JC-35W G4 PREMIUM	10726	52
JC-35W GY6.35 PREMIUM	10732	53
JC-35W4/EK BASIC	10434	52
JC-50W GY6.35 PREMIUM	10734	53
JC-5W G4 PREMIUM	10720	52
JDR+A20W36C PREMIUM	10761	52
JDR+A20W60C PREMIUM	10767	52
JDR+A20W60C/EK BASIC	10814	52
JDR+A35W36C PREMIUM	10763	52
JDR+A35W60C PREMIUM	10769	52
JDR+A35W60C/EK BASIC	10815	52
JDR+A50W36C PREMIUM	10765	52
JDR+A50W60C PREMIUM	10771	52
JDR+A50W60C/EK BASIC	10816	52
JEN CE-82-B	00606	164
JEN CE-82-B BALTA	07460	162
JEN CE-82PX-B	00657	167
JEN CE-82PX-W	00658	167

Model	Kód	Strana
JEN CE-82-W	00608	164
JUTA LED30 E14-WW	07550	29
JUTA LED30 E27-WW	07551	29
JVC2-20/2	03801	178
JVD1-100 1/25A	03810	177
JVD1-100 1/40A	03811	177
JVD1-100 3/100A	03819	178
JVD1-100 3/25A	03815	178
JVD1-100 3/40A	03816	178
JVD1-100 3/63A	03817	178
JVD1-100 3/80A	03818	178
JVL5/2 B16/0,03A	03870	177
JVL5/2 B25/0,03A	03871	177
KALI LED36 E27-WW	07590	28
KIRA DL-29	07191	138
KIRA DL-29B	07901	138
KIRA DL-75	07190	138
KIRA DL-75B	07900	138
KODI NL4636-WHITE	11173	119
KONRAT DL-LED24A	07740	144
KONRAT DL-LED24B	07741	144
KR6 25/003/2	04470	176
KR6 25/003/4	04485	176
KR6 40/003/2	04471	176
KR6 40/003/4	04486	176
KR6 63/003/2	04472	176
KR6 63/003/4	04487	176
KREON TL-GX53	07440	98
KS6 B1/1	04410	172
KS6 B10/1	04414	172
KS6 B10/3	04451	174
KS6 B13/1	04415	172
KS6 B16/1	04416	172
KS6 B16/3	04452	174
KS6 B2/1	04411	172
KS6 B20/1	04417	172
KS6 B20/3	04453	174
KS6 B25/1	04418	172
KS6 B25/3	04454	174
KS6 B32/1	04419	172
KS6 B32/3	04455	174
KS6 B4/1	04412	172
KS6 B40/1	04420	172
KS6 B40/3	04456	174
KS6 B50/3	04457	174
KS6 B6/1	04413	172
KS6 B6/3	04450	174
KS6 B63/3	04458	174
KS6 C10/1	04434	173
KS6 C10/3	04461	175
KS6 C16/1	04435	173
KS6 C16/3	04462	175
KS6 C2/1	04431	173
KS6 C20/1	04436	173
KS6 C20/3	04463	175
KS6 C25/1	04437	173
KS6 C25/3	04464	175
KS6 C32/1	04438	173
KS6 C32/3	04465	175
KS6 C4/1	04432	173
KS6 C40/1	04439	173
KS6 C40/3	04466	175
KS6 C50/3	04467	175
KS6 C6/1	04433	173
KS6 C6/3	04460	175
KS6 C63/3	04468	175
KSENIA DL-POWER LED	07350	88
LAB LED30 E14-WW	07552	29
LAB LED30 E27-WW	07553	29
LED12 GU10-CW	12630	36

Model	Kód	Strana
LED20 GU10-BL	12622	36
LED20 GU10-CW	12620	36
LED20 GU10-GN	12621	36
LED20 GU10-RE	12624	36
LED20 GU10-WW	12625	36
LED20 GU10-Y	12623	36
LED20 MR16-BL	12766	33
LED20 MR16-CW	12760	33
LED20 MR16-GN	12765	33
LED20 MR16-RE	12768	33
LED20 MR16-WW	12761	33
LED20 MR16-Y	12767	33
LED48 GU10-CW	07671	35
LED48 GU10-WW	07670	35
LED48 MR16-CW	07681	32
LED48 MR16-WW	07680	32
LED60 E14-CW	07820	31
LED60 E14-WW	07821	31
LED60 E27-CW	07822	31
LED60 E27-WW	07823	31
LED60 GU10-CW	07831	35
LED60 GU10-WW	07830	35
LED60 MR16-CW	07841	33
LED60 MR16-WW	07840	33
LEVEL EL-150L	07236	108
LICA LED-J04A	04684	143
LIGO DX-3G1.0MM2 1.5M	01782	192
LIGO DX-3G1.0MM2 3M	01780	192
LIGO DX-3G1.0MM2 5M	01781	192
LIGO DX-3G1.5MM2 2M	01785	192
LIGO DX-3G1.5MM2 3M	01786	192
LINDA LED-J02	04681	143
LINEAL 3LED12	07120	101
LOMA 1000-B	04675	163
LORA HR-DF5-B	01914	92
LORA HR-DF5-BLN	01910	92
LORA HR-DF5-GN	01913	92
LORA HR-DF5-RE	01911	92
LORA HR-DF5-W	01912	92
LUCA LED48 E14-WW	07581	28
LUCA LED48 E27-WW	07580	28
LUTO CTX-DS02B-AB	02584	62
LUTO CTX-DS02B-C	02581	62
LUTO CTX-DS02B-C/M	02583	62
LUTO CTX-DS02B-W	02580	62
LUTO CTX-DT02B-AB	02594	63
LUTO CTX-DT02B-C	02591	63
LUTO CTX-DT02B-C/M	02593	63
LUTO CTX-DT02B-W	02590	63
LUVEN MX-216/21W-W	04240	134
LUVEN MX-218/38W-W	04241	134
MADRE SX2037 BLN/T	01931	91
MADRE SX2037 BLN/TR	01935	91
MADRE SX2037 GF/T	01933	91
MADRE SX2037 GFD/T	01934	91
MADRE SX2037 GN/T	01930	91
MADRE SX2037 RE/T	01932	91
MAH-1118/A	03970	129
MAH-1118/A-PS	04510	131
MAH-1136/A	03972	129
MAH-1136/A-PS	04511	131
MAH-1158/A	03974	129
MAH-1158/A-PS	04512	131
MAH-1218/A	03971	130
MAH-1218/A-PS	04513	132
MAH-1236/A	03973	130
MAH-1236/A-PS	04514	132
MAH-1236-EVG/A	04273	130
MAH-1236EVG/A-PS	04285	132
MAH-1258/A	03975	130

Model	Kód	Strana
MAH-1258/A/CP	03985	130
MAH-1258/A-PS	04515	132
MANGO KF-FBG-20A 25M	04395	191
MANGO KF-FBG-23A 40M	04396	191
MANGO KF-FBG-23A 50M	04397	191
MARC DL-60	07015	136
MARIN CT-S80-AB	04710	75
MARIN CT-S80-C	04703	75
MARIN CT-S80-SN	04704	75
MATEO DLP-150-GR	04960	152
MATEO DLP-250-GR	04961	152
MATEO DLP-350-GR	04962	152
MATEO DLP-450-GR	04963	152
MATMA MTH-150	04816	158
MATMA MTH-70	04815	158
MAYOR DLP-226-W	04942	148
MB18/20	70470	198
MB36/40	70471	198
MB58	70472	198
MEBA TL-218	07250	127
MEBA TL-218/OP	07252	127
MEBA TL-236	07251	127
MEBA TL-236/OP	07253	127
MEDIA MTH-150-GR	04911	154
MEDIA MTH-150-W	04909	154
MEDIA MTH-70-GR	04910	154
MEDIA MTH-70-W	04908	154
MERA PP	04733	210
MERA TL-13	04731	104
MERA TL-21	04732	104
MERA TL-8	04730	104
MERGE JQ-L	07690	201
MERGE JQ-O	07691	201
MEX CE-81-B	00600	164
MEX CE-81PX-B	00655	167
MEX CE-81PX-W	00656	167
MEX CE-81-W	00602	164
MEZO CE-81P-Y-B	00666	168
MEZO CE-81P-Y-W	00667	168
MEZO CE-81-Y-B	00664	165
MEZO CE-81-Y-W	00665	165
MHE-250W/4200K	12755	55
MHE-400W/4200K	12756	55
MHR-150W/3000K	12751	55
MHR-70W/3000K	12750	55
MIG LED-4L	04791	107
MIG LED-4O	04790	107
MIKA CTX-42+B2-SN/N	02875	72
MIKA CTX-42+D-MPC/N	02876	72
MILO 7040T	70522	139
MILO 7040T/P	70523	139
MINIGLOB XEU48-11XG E14/K	12696	44
MINIGLOB XEU48-9XG E14/K	12695	44
MIRON KT040-GF/T	07200	93
MIZAK DX-02-Y 1.5 15M	02033	191
MIZAK DX-02-Y 1.5 25M	02034	191
MOLI EL-1O	07085	111
MOLI EL-2I	07086	111
MOLI EL-3O	07087	111
MOLI EL-4I	07088	111
MORO DL-35	04870	146
MOSKITO T5	12705	118
MR-11C 20W30 PREMIUM	10363	53
MR-11C 20W30/EK BASIC	12517	53
MR-11C 35W30 PREMIUM	10364	53
MR-11C 35W30/EK BASIC	12518	53
MR-16C 20W36 PREMIUM	10302	54
MR-16C 20W36/EK BASIC	12502	54
MR-16C 20W60 PREMIUM	10303	54
MR-16C 20W60/EK BASIC	12503	54

Model	Kód	Strana
MR-16C 35W36 PREMIUM	10306	54
MR-16C 35W36/EK BASIC	12506	54
MR-16C 35W60 PREMIUM	10307	54
MR-16C 35W60/EK BASIC	12507	54
MR-16C 50W40 PREMIUM	10311	54
MR-16C 50W40/EK BASIC	12511	54
MR-16C 50W60 PREMIUM	10312	54
MR-16C 50W60/EK BASIC	12512	54
NAVI CTX-DS10-AB	04693	66
NAVI CTX-DS10-C	04694	66
NAVI CTX-DS10-SN	04695	66
NAVI CTX-DT10-AB	02554	67
NAVI CTX-DT10-C	02551	67
NAVI CTX-DT10-C/M	02553	67
NAVI CTX-DT10-G	02552	67
NAVI CTX-DT10-W	02550	67
NAZAR DLP-200 226-WH	04371	151
NELI SX388 35W-B	01852	91
NELI SX388 35W-B/T	01854	91
NELI SX388 35W-BLN/T	01867	91
NELI SX388 35W-GF/T	01869	91
NELI SX388 35W-GND/T	01868	91
NELI SX388 35W-PU/T	01870	91
NELI SX388 35W-W/T	01855	91
NIKOR DLP-60-W	07210	148
NIKOR DLP-75-W	07211	148
NOMA CTX-DS10G/A-C	02561	68
NOMA CTX-DS10G/B-C	02566	68
NOTUS 218 PAR NT	07890	125
NOTUS 218-EVG PAR NT	07891	125
NOTUS 236 PAR NT	04652	125
NOTUS 236-EVG PAR NT	04657	125
NOTUS 418 PAR NT	04651	125
NOTUS 418-EVG PAR NT	04656	125
ODA LED12 E27-BL	07392	30
ODA LED12 E27-GN	07393	30
ODA LED12 E27-RE	07391	30
ODA LED12 E27-WW	07394	30
ODA LED12 E27-Y	07390	30
OFRA TL-218A-SR	07092	128
OFRA TL-218A-W	07090	128
OFRA TL-218B-SR	07097	128
OFRA TL-218B-W	07095	128
OFRA TL-236A-SR	07093	128
OFRA TL-236A-W	07091	128
OFRA TL-236B-SR	07098	128
OFRA TL-236B-W	07096	128
OTIS CE-82P-Y-B	00676	168
OTIS CE-82P-Y-W	00677	168
OTIS CE-82-Y-B	00674	165
OTIS CE-82-Y-W	00675	165
OTON RT060-1011K	70402	197
OTON RT100-1011K	70403	197
OTON RT150-1011K	70426	197
OTON RT200-1011K	70406	197
OTON RT250-1011K	70407	197
OTON RT300-1011K	70408	197
OZON DLBS-1AV/27-C	00907	79
OZON DLBS-1AV/27-C/M	00908	79
OZON DLBS-1AV/27-W	00905	79
PACO LED28-B	07620	161
PACO LED45-B	07610	161
PARLE CTC-5519-MPC/N	02753	61
PARLE CTC-5519-PG/N	02754	61
PARLE CTC-5519-PS/G	02751	61
PARLE CTC-5519-SN/G	02750	61
PARLE CTC-5519-SN/N	02752	61
PASAT 150-C/M	04315	154
PASAT 70-C/M	04310	154
PAX TL2016B-13W-SR	04282	105

Model	Kód	Strana
PAX TL2016B-8W-SR	04281	105
PC252/PA	02120	206
PC253/PA	02121	206
PC254/PA	02122	206
PC255/PA	02123	206
PERS CT-DS94-C/W	04702	75
PERU 150	04781	199
PERU 70	04780	199
PIN W/US	02186	193
PORTOS 11	04671	133
POWER-3LED GU10-CW	07660	34
POWER-3LED GU10-WW	07661	34
POWER-3LED MR16-CW	07650	32
POWER-3LED MR16-WW	07651	32
POWER-LED GU10-CW	12801	34
POWER-LED GU10-WW	12800	34
POWER-LED MR16-CW	12811	31
POWER-LED MR16-WW	12810	31
PRO DR-16B-BR/M	72192	89
PRO DR-16B-C	72111	89
PRO DR-16B-C/M	72139	89
QULES CT-DS83-SN	04706	76
R39 30W E14/K	12550	50
R50 25W E14/K	12551	50
R50 40W E14/K	12552	50
R50 60W E14/K	12553	50
R63 40W E27/K	12554	50
R63 60W E27/K	12555	50
RADAN CT-DSL50	07363	61
RADAN CT-DSO50	07362	61
RADAN CT-DTL50	07361	62
RADAN CT-DTO50	07360	62
RAGO DL-R39-C	01063	80
RAGO DL-R39-C/M	01064	80
RAGO DL-R39T-AB	01065	80
RAGO DL-R39T-C	01068	80
RAGO DL-R39T-C/M	01069	80
RAGO DL-R50-AB	01070	81
RAGO DL-R50-C	01073	81
RAGO DL-R50-C/M	01074	81
RAGO DL-R50E-C	01078	82
RAGO DL-R50E-C/M	01077	82
RAGO DL-R50-G	01072	81
RAGO DL-R50-W	01071	81
RAGO DL-R63-C	01083	83
RAGO DL-R63-C/M	01084	83
RAGO DL-R63-W	01081	83
RALF DL-220-W	04820	149
REA LED12 E14-BL	07382	30
REA LED12 E14-GN	07383	30
REA LED12 E14-RE	07381	30
REA LED12 E14-WW	07384	30
REA LED12 E14-Y	07380	30
REGIS 418 PAR PT	04650	121
REGIS 418-EVG PAR PT	04655	121
RESO CTX-KW10-AN	04325	68
RESO CTX-KW10-C	04326	68
RESO CTX-KW10-C/M	04327	68
RESO POWER LED	07720	87
REVA MTH-150/A	04839	159
REVA MTH-150/S	04838	158
REVA MTH-70/A	04836	159
REVA MTH-70/S	04835	158
RICO LED 10-18W	07302	195
RICO LED 15-24W	07301	195
RICO LED 4-6W	07300	195
RICO LED 9-12W	07303	195
RODOS CT-DS09-AB	04685	65
RODOS CT-DS09-C	04686	65
RODOS CT-DS09-SN	04687	65

Model	Kód	Strana
RODOS CT-DT09-AB	04688	66
RODOS CT-DT09-C	04689	66
RODOS CT-DT09-SN	04690	66
ROGER DL-2LED6	07281	145
ROGER DL-LED12	07280	145
ROLO JQ-L	00466	205
ROLO JQ-O	00465	205
RONA CT-AS11-AL	04700	69
ROPE-NT 150	07870	212
RUBIX CTX-40+B3-SN/N	02863	71
RUBIX CTX-40+D-C	02862	71
SALI 1500-B	04676	163
SALUT DL-138RA/1-C	00933	100
SALUT DL-138RA/1-C/M	00932	100
SALUT DL-305-S-BR/M	00944	99
SALUT DL-305-S-C	00942	99
SALUT DL-305-S-C/M	00943	99
SALUT DL-307-S-BR/M	00949	99
SALUT DL-307-S-C	00947	99
SALUT DL-307-S-C/M	00948	99
SAXO LED KT-58	07520	96
SEDNA CTX-A20AB	04978	84
SEDNA CTX-A20C/M	04977	84
SEDNA POWER LED	07700	88
SELVA MTH-150-W	04905	153
SENSORSPIRAL ETU-CSS 11W E27/K	12640	38
SENSORSPIRAL ETU-CSS 20W E27/K	12641	38
SET105-K	01426	197
SET150-N	01432	197
SET210-N	01433	197
SET60 ULTRA SLIM	01435	196
SET60-K	01425	197
SET80 ULTRA SLIM	01436	196
SET80LT	01421	197
SHARK EL-60	07011	141
SL-GN GREEN	03821	180
SLOT DLP-100G 218-WH	04350	151
SLOT DLP-100G 226-WH	04351	151
SL-RE RED	03820	180
SOLO TOE10-230V	01100	119
SONDA EL-1L	04795	112
SONDA EL-2J	04796	112
SONDA EL-3J	04797	112
SONDA EL-4L	04798	112
SORIN LED EL-21L-UP	07500	116
SORIN LED EL-32I-UP	07501	116
SORIN LED EL-40	07502	116
SORIN LED EL-70	07503	116
SPIRAL ETU-MSS 11W E27/K	12606	38
SPIRAL ETU-MSS 15W E27/K	12607	38
SPIRAL ETU-MSS 7W E14/K	12600	38
SPIRAL ETU-MSS 9W E27/K	12605	38
SPIRAL ETU-SS 24W E27/K	12645	38
SPR.CT-21/MR11	72122	209
SPR.CT-21/MR16	72121	209
SPR.CTC-31/MR16	72279	209
SPR.CTC-55/MR11	72277	209
SPR.CTC-55/MR16	72278	209
STAN GP	04864	194
STER TS-MF1	01001	204
SUPERGLOB XEU23-15G1 E27/K	10612	45
SUPERGLOB XEU38-20G E27/K	10620	45
SUPERSHAPE BH4-11X E14/K	10502	37
SUPERSHAPE BH4-11X E27/K	10503	37
SUPERSHAPE BH4-15W E27/K	10504	37
SUPERSHAPE BH4-20W E27/K	10505	37
SUPERSHAPE BH4-9X E14/K	10500	37
SUPERSHAPE BH4-9X E27/K	10501	37
SUPERSHAPE BH5-24W E27/K	10506	37
SUPERSLIM ETU-M11W E27/K	12616	40

Model	Kód	Strana
SUPERSLIM ETU-M15W E27/K	12617	40
SUPERSLIM ETU-M20W E27/K	12618	40
SUPERSLIM ETU-M9W E27/K	12615	40
SUZI HR-60-B	07151	93
SUZI HR-60-BL	07152	93
SUZI HR-60-PK	07153	93
SUZI HR-60-SR	07150	93
SYLENI 1030 MY/ML-SR	70795	115
SYLENI 1130 SY/ML-SR	70793	115
T1U-11W/K	10672	48
T1U-9W/K	10671	48
T2U-18W/K	10661	48
T2U-26W/K	10662	48
T4-12W 4000K	10931	50
T4-16W 4000K	10932	50
T4-20W 4000K	10933	50
T4-8W 4000K	10930	50
T5-13W 2700K/65	12711	49
T5-13W 4000K/65	12716	49
T5-14W 2700K/82	12712	49
T5-14W 4000K/82	12717	49
T5-21W 2700K/82	12713	49
T5-21W 4000K/82	12718	49
T5-8W 2700K/65	12710	49
T5-8W 4000K/65	12715	49
TABO CT-AS02-AL	04701	70
TAXI LED12PR WH-C/M	04391	144
TAXI LED12PR WW-C/M	04393	144
TAXI LED9KW WH-C/M	04390	144
TAXI LED9KW WW-C/M	04392	144
TEMA DX-3F 1.5M	01500	189
TEMA DX-3F 3M	01502	189
TEMA DX-3F 5M	01504	189
TEMA DX-3FS 1.5M	01507	190
TEMA DX-3FS 3M	01509	190
TEMA DX-3FS 5M	01511	190
TEMA DX-5F 3M	01558	189
TEMA DX-5F 5M	01560	189
TEMA DX-5FS 3M	01565	190
TEMA DX-5FS 5M	01567	190
TESON AL-DSL50	07373	78
TESON AL-DSO50	07372	78
TESON AL-DTL50	07371	79
TESON AL-DTO50	07370	79
TETRIS 2LED15	07240	101
TETRIS LED15	07241	101
TIVA 1030 1/2DR/ML-DB	70741	114
TIVA 1030 1/2DR/ML-MH	70742	114
TIVA 1030 1/2DR/ML-OL	70747	115
TIVA 1030 1/2DR/ML-SN	70740	113
TIVA 1030 MDR/ML-DB	70731	114
TIVA 1030 MDR/ML-MH	70732	114
TIVA 1030 MDR/ML-OL	70737	115
TIVA 1030 MDR/ML-SN	70730	113
TIVA 1030 SDR/ML-DB	70721	114
TIVA 1030 SDR/ML-MH	70722	114
TIVA 1030 SDR/ML-OL	70727	115
TIVA 1030 SDR/ML-SN	70720	113
TIVA 1130 DDR/ML-DB	70711	114
TIVA 1130 DDR/ML-MH	70712	114
TIVA 1130 DDR/ML-OL	70717	115
TIVA 1130 DDR/ML-SN	70710	113
TOKEN 236 NT	04827	126
TOKEN 418 NT	04826	126
TOMA EL-10	01020	109
TOMA EL-2I	01021	109
TOMA EL-3I	01022	109
TOMA EL-3O	01023	109
TOMA EL-4I	01024	109
TOSA CT-DS87-SN	04697	67

Model	Kód	Strana
TRAP ZW3-L150P-B	00616	170
TRETO LED	07800	196
TRISTAN CTX-10+K1-C	02893	74
TRISTAN CTX-10+K2-C	02890	74
TRISTAN CTX-10+K3-C	02892	74
TRISTAN CTX-10+K4-C	02891	74
TUNA S1101-W	04260	137
TURK DL-60	07025	140
TURO MTH-150	04981	147
TURO MTH-70	04980	147
TWISTER AOL100B	70926	186
TWISTER AOL100T	70953	186
TWISTER AOL120B	70956	186
TWISTER AOL120T	70960	186
ULKE CT-2113-C	00321	56
ULKE CT-2113-C/M	00355	56
ULKE CT-2118-C	00315	57
ULKE CT-2118-C/M	00343	57
ULKE CT-2119-BR/M	00348	57
ULKE CT-2119-C	00313	57
ULKE CT-2119-C/M	00349	57
VABI DL-RS50-C	04930	82
VABI DL-RS50-C/M	04931	82
VANTI EL-I440	07235	108
VARIO DL-220-W	04821	149
VELO CT-AS83-AL	04709	77
VERA LED EL-18L-UP	07470	116

Model	Kód	Strana
VERA LED EL-22I-UP	07471	116
VERA LED EL-30	07472	116
VERA LED EL-50	07473	116
VERA LED EL-85	07474	116
VIDI CTC-5514-AN	02795	63
VIDI CTC-5514-C	02791	63
VIDI CTC-5514-C/M	02793	63
VIDI CTC-5514-W	02790	63
VIDI CTC-5515-AN	02785	64
VIDI CTC-5515-C	02781	64
VIDI CTC-5515-C/M	02783	64
VIDI CTC-5515-G	02786	64
VIDI CTC-5515-W	02780	64
VIGA DL-28L	04852	135
VIGA DL-28O	04851	135
VISTO DL-213O	04990	134
VISTO DL-75O	04991	134
VITAM EL-60	04865	141
VOLCANO LED-BL 5M	07290	102
VOLCANO LED-CW 5M	07294	102
VOLCANO LED-GN 5M	07292	102
VOLCANO LED-OR 5M	07296	102
VOLCANO LED-RE 5M	07291	102
VOLCANO LED-WW 5M	07295	102
VOLCANO LED-Y 5M	07293	102
VOLIN EL-9-B	04805	133
VOLIN EL-9-W	04806	133

Model	Kód	Strana
VOLKER 418 PT	04825	122
WIR WK-10	70900	188
WIR WK-12	70901	188
WIR WK-15	70903	188
WIR ZL100	70961	189
XARD DL-40	07195	147
XEDOS 414 NT-EVG	04832	124
Z1-BBU/3	02159	181
ZARA HR-40-B	07561	92
ZARA HR-40-BL	07562	92
ZARA HR-40-OR	07563	92
ZARA HR-40-SR	07560	92
ZARK KRT/2-1	02180	192
ZARK KRW-3	02181	192
Z-DB	03859	182
ZENA EL-2	07231	107
ZENA EL-4	07230	107
ZEPO LFD-T02/S-BR/M	04389	100
ZEPO LFD-T02/S-C	04385	100
ZEPO LFD-T02/S-C/M	04386	100
ZEPO LFD-T02-C	04380	100
ZEPO LFD-T02-C/M	04381	100
ZEW EL-235J	04971	142
ZEW EL-235U	04970	142
ZONA JQ-37-W	00464	202

## 00300 - 01021

## 0 - 9

Zoznam podľa kódov Kanlux

Kód	Model	Strana
00300	ARGUS CT-2114-G	58
00301	ARGUS CT-2114-C	58
00303	ARGUS CT-2114-W	58
00304	ARGUS CT-2115-G	58
00305	ARGUS CT-2115-C	58
00307	ARGUS CT-2115-W	58
00308	ARGUS CT-2117-G	59
00309	ARGUS CT-2117-C	59
00311	ARGUS CT-2117-W	59
00313	ULKE CT-2119-C	57
00315	ULKE CT-2118-C	57
00321	ULKE CT-2113-C	56
00324	ARGUS CT-2114-BR/M	58
00325	ARGUS CT-2114-C/M	58
00327	ARGUS CT-2114-AN	58
00328	ARGUS CT-2114-GM	58
00330	ARGUS CT-2115-BR/M	58
00331	ARGUS CT-2115-C/M	58
00333	ARGUS CT-2115-AN	58
00334	ARGUS CT-2115-GM	58
00335	ARGUS CT-2115-YG	58
00336	ARGUS CT-2117-BR/M	59
00337	ARGUS CT-2117-C/M	59
00339	ARGUS CT-2117-AN	59
00340	ARGUS CT-2117-GM	59
00343	ULKE CT-2118-C/M	57
00348	ULKE CT-2119-BR/M	57
00349	ULKE CT-2119-C/M	57
00355	ULKE CT-2113-C/M	56
00402	HLDR-GZ10	207
00405	HLDR-R7S	207
00460	ALER JQ-30-W	202
00461	ALER JQ-30-B	202
00464	ZONA JQ-37-W	202
00465	ROLO JQ-O	205

Kód	Model	Strana
00466	ROLO JQ-L	205
00505	ELMA 6898-81	203
00506	ELMA 6898-80	203
00510	GLORIA TL3011-18W	104
00511	GLORIA TL3011-30W	104
00520	GRELA TL2004B-8W	103
00521	GRELA TL2004B-12W	103
00522	GRELA TL2004B-16W	103
00523	GRELA TL2004B-20W	103
00525	CONNECT TL2004B-PP	210
00530	GRELA TL2004C-8W-SR	103
00531	GRELA TL2004C-12W-SR	103
00532	GRELA TL2004C-16W-SR	103
00533	GRELA TL2004C-20W-SR	103
00535	EVAN TL-8	106
00536	EVAN TL-13	106
00600	MEX CE-81-B	164
00602	MEX CE-81-W	164
00606	JEN CE-82-B	164
00608	JEN CE-82-W	164
00616	TRAP ZW3-L150P-B	170
00620	ELIOT ZW3-L500P-B	170
00655	MEX CE-81PX-B	167
00656	MEX CE-81PX-W	167
00657	JEN CE-82PX-B	167
00658	JEN CE-82PX-W	167
00664	MEZO CE-81-Y-B	165
00665	MEZO CE-81-Y-W	165
00666	MEZO CE-81P-Y-B	168
00667	MEZO CE-81P-Y-W	168
00674	OTIS CE-82-Y-B	165
00675	OTIS CE-82-Y-W	165
00676	OTIS CE-82P-Y-B	168
00677	OTIS CE-82P-Y-W	168
00680	FARE SL-150R-F-B	166

Kód	Model	Strana
00681	FARE SL-150R-F-W	166
00682	FARE SL-150R-P-B	169
00683	FARE SL-150R-P-W	169
00685	EDIT SL-300R-F-B	166
00686	EDIT SL-300R-F-W	166
00687	EDIT SL-300R-P-B	169
00688	EDIT SL-300R-P-W	169
00810	GAVI CT-2116B-W	86
00811	GAVI CT-2116B-C	86
00813	GAVI CT-2116B-G	86
00814	GAVI CT-2116B-BR/M	86
00815	GAVI CT-2116B-C/M	86
00817	GAVI CT-2116B-AN	86
00821	ELSE CT-2116C-C	84
00823	ELSE CT-2116C-G	84
00825	ELSE CT-2116C-C/M	84
00905	OZON DLBS-1AV/27-W	79
00907	OZON DLBS-1AV/27-C	79
00908	OZON DLBS-1AV/27-C/M	79
00911	DELE AL-204-C	77
00913	DELE AL-204-C/M	77
00921	DELE AL-205-C	78
00923	DELE AL-205-C/M	78
00932	SALUT DL-138RA/1-C/M	100
00933	SALUT DL-138RA/1-C	100
00942	SALUT DL-305-S-C	99
00943	SALUT DL-305-S-C/M	99
00944	SALUT DL-305-S-BR/M	99
00947	SALUT DL-307-S-C	99
00948	SALUT DL-307-S-C/M	99
00949	SALUT DL-307-S-BR/M	99
01001	STER TS-MF1	204
01016	CYBER TM-6	204
01020	TOMA EL-1O	109
01021	TOMA EL-2I	109

Kód	Model	Strana
01022	TOMA EL-3I	109
01023	TOMA EL-3O	109
01024	TOMA EL-4I	109
01063	RAGO DL-R39-C	80
01064	RAGO DL-R39-C/M	80
01065	RAGO DL-R39T-AB	80
01068	RAGO DL-R39T-C	80
01069	RAGO DL-R39T-C/M	80
01070	RAGO DL-R50-AB	81
01071	RAGO DL-R50-W	81
01072	RAGO DL-R50-G	81
01073	RAGO DL-R50-C	81
01074	RAGO DL-R50-C/M	81
01077	RAGO DL-R50E-C/M	82
01078	RAGO DL-R50E-C	82
01081	RAGO DL-R63-W	83
01083	RAGO DL-R63-C	83
01084	RAGO DL-R63-C/M	83
01100	SOLO TOE10-230V	119
01257	IT-1/10-B	205
01258	IT-1/10-Y	205
01259	IT-1/10-RE	205
01260	IT-1/10-GN	205
01261	IT-1/10-BL	205
01262	IT-1/10-W	205
01263	IT-1/10-Y/GN	205
01271	IT-1/20-B	205
01272	IT-1/20-Y	205
01273	IT-1/20-RE	205
01274	IT-1/20-GN	205
01275	IT-1/20-BL	205
01276	IT-1/20-W	205
01277	IT-1/20-Y/GN	205
01421	SET80LT	197
01425	SET60-K	197
01426	SET105-K	197
01432	SET150-N	197
01433	SET210-N	197
01435	SET60 ULTRA SLIM	196
01436	SET80 ULTRA SLIM	196
01440	ADI 65	195
01500	TEMA DX-3F 1.5M	189
01502	TEMA DX-3F 3M	189
01504	TEMA DX-3F 5M	189
01507	TEMA DX-3FS 1.5M	190
01509	TEMA DX-3FS 3M	190
01511	TEMA DX-3FS 5M	190
01558	TEMA DX-5F 3M	189
01560	TEMA DX-5F 5M	189
01565	TEMA DX-5FS 3M	190
01567	TEMA DX-5FS 5M	190
01780	LIGO DX-3G1.0MM2 3M	192
01781	LIGO DX-3G1.0MM2 5M	192
01782	LIGO DX-3G1.0MM2 1.5M	192
01785	LIGO DX-3G1.5MM2 2M	192
01786	LIGO DX-3G1.5MM2 3M	192
01826	GOLBA SX065 20W-B	90
01827	GOLBA SX065 20W-W	90
01828	GOLBA SX065 20W-B/T	90
01829	GOLBA SX065 20W-W/T	90
01841	GOLBA SX065 20W-BLN/T	90
01842	GOLBA SX065 20W-GND/T	90
01843	GOLBA SX065 20W-GF/T	90
01844	GOLBA SX065 20W-PU/T	90
01852	NELI SX388 35W-B	91
01854	NELI SX388 35W-B/T	91
01855	NELI SX388 35W-W/T	91
01867	NELI SX388 35W-BLN/T	91
01868	NELI SX388 35W-GND/T	91
01869	NELI SX388 35W-GF/T	91

Kód	Model	Strana
01870	NELI SX388 35W-PU/T	91
01871	IBIS KT028C-BL	95
01872	IBIS KT028C-GN	95
01873	IBIS KT028C-GR	95
01878	HERON KT017C-W	96
01879	HERON KT017C-B	96
01881	IBIS KT030-BL	94
01882	IBIS KT030-GN	94
01883	IBIS KT030-GR	94
01886	IBIS KT028-BL	95
01887	IBIS KT028-GN	95
01888	IBIS KT028-GR	95
01910	LORA HR-DF5-BLN	92
01911	LORA HR-DF5-RE	92
01912	LORA HR-DF5-W	92
01913	LORA HR-DF5-GN	92
01914	LORA HR-DF5-B	92
01930	MADRE SX2037 GN/T	91
01931	MADRE SX2037 BLN/T	91
01932	MADRE SX2037 RE/T	91
01933	MADRE SX2037 GF/T	91
01934	MADRE SX2037 GFD/T	91
01935	MADRE SX2037 BLN/TR	91
02020	FINAR DX-02-Y 1.0 3M	190
02021	FINAR DX-02-Y 1.0 5M	190
02033	MIZAK DX-02-Y 1.5 15M	191
02034	MIZAK DX-02-Y 1.5 25M	191
02100	H-2.5MM2 PP	206
02101	H-4MM2 PP	206
02102	H-6MM2 PP	206
02103	H-10MM2 PP	206
02104	H-16MM2 PP	206
02120	PC252/PA	206
02121	PC253/PA	206
02122	PC254/PA	206
02123	PC255/PA	206
02155	BBU12/1	180
02156	BBU12/3	181
02157	BBU56/1	180
02158	BBU54/3	181
02159	Z1-BBU/3	181
02160	HLDR-E27	207
02161	HLDR-E27-F	207
02162	HLDR-E27-D	207
02170	HLDR-E14	207
02180	ZARK KRT/2-1	192
02181	ZARK KRW-3	192
02185	DAN KGP-1	193
02186	PIN W/US	193
02550	NAVI CTX-DT10-W	67
02551	NAVI CTX-DT10-C	67
02552	NAVI CTX-DT10-G	67
02553	NAVI CTX-DT10-C/M	67
02554	NAVI CTX-DT10-AB	67
02561	NOMA CTX-DS10G/A-C	68
02566	NOMA CTX-DS10G/B-C	68
02571	DINO CTX-DS02G/A-C	69
02576	DINO CTX-DS02G/B-C	69
02580	LUTO CTX-DS02B-W	62
02581	LUTO CTX-DS02B-C	62
02583	LUTO CTX-DS02B-C/M	62
02584	LUTO CTX-DS02B-AB	62
02590	LUTO CTX-DT02B-W	63
02591	LUTO CTX-DT02B-C	63
02593	LUTO CTX-DT02B-C/M	63
02594	LUTO CTX-DT02B-AB	63
02750	PARLE CTC-5519-SN/G	61
02751	PARLE CTC-5519-PS/G	61
02752	PARLE CTC-5519-SN/N	61
02753	PARLE CTC-5519-MPC/N	61

Kód	Model	Strana
02754	PARLE CTC-5519-PG/N	61
02755	CEL CTC-5519-C/M	60
02780	VIDI CTC-5515-W	64
02781	VIDI CTC-5515-C	64
02783	VIDI CTC-5515-C/M	64
02785	VIDI CTC-5515-AN	64
02786	VIDI CTC-5515-G	64
02790	VIDI CTC-5514-W	63
02791	VIDI CTC-5514-C	63
02793	VIDI CTC-5514-C/M	63
02795	VIDI CTC-5514-AN	63
02800	BASK CTC-5515-PG/N	65
02803	BASK CTC-5515-SN/G	65
02804	BASK CTC-5515-MPC/N	65
02805	BASK CTC-5515-SG/N	65
02806	BASK CTC-5515-SN/N	65
02810	BASK CTC-5514-PG/N	64
02813	BASK CTC-5514-SN/G	64
02814	BASK CTC-5514-MPC/N	64
02815	BASK CTC-5514-SG/N	64
02816	BASK CTC-5514-SN/N	64
02820	HORN CTC-3114-SN/G	59
02821	HORN CTC-3114-SN/N	59
02822	HORN CTC-3114-PS/G	59
02823	HORN CTC-3114-PG/N	59
02824	HORN CTC-3114-GM/N	59
02830	HORN CTC-3115-SN/G	60
02831	HORN CTC-3115-SN/N	60
02832	HORN CTC-3115-PS/G	60
02833	HORN CTC-3115-PG/N	60
02834	HORN CTC-3115-GM/N	60
02860	EDYP CTX-40+P-C	73
02861	EDYP CTX-40+P-SN/N	73
02862	RUBIX CTX-40+D-C	71
02863	RUBIX CTX-40+B3-SN/N	71
02871	DANTE CTX-41+D-C	73
02875	MIKA CTX-42+B2-SN/N	72
02876	MIKA CTX-42+D-MPC/N	72
02880	GAVEL CTX-20+D-MPC/N	72
02881	GAVEL CTX-20+B2-SN/N	72
02882	GAVEL CTX-20+B1-SN/G	72
02890	TRISTAN CTX-10+K2-C	74
02891	TRISTAN CTX-10+K4-C	74
02892	TRISTAN CTX-10+K3-C	74
02893	TRISTAN CTX-10+K1-C	74
02895	IGLO CTX-30+G-C/M	74
02896	IGLO CTX-30+SQ-C/M	74
02897	ALTER CTX-50+04-C/M	85
02899	ALTER CTX-50+04-AB	85
03801	JVC2-20/2	178
03805	EB230 230V	179
03806	BT-8 8/12/24V	179
03810	JVD1-100 1/25A	177
03811	JVD1-100 1/40A	177
03815	JVD1-100 3/25A	178
03816	JVD1-100 3/40A	178
03817	JVD1-100 3/63A	178
03818	JVD1-100 3/80A	178
03819	JVD1-100 3/100A	178
03820	SL-RE RED	180
03821	SL-GN GREEN	180
03830	DB1045 1X4P/SMD	183
03831	DB1065 1X6P/SMD	183
03832	DB1085 1X8P/SMD	183
03833	DB1125 1X12P/SMD	183
03834	DB1185 1X18P/SMD	183
03835	DB2125 2X12P/SMD	184
03836	DB3125 3X12P/SMD	184
03840	DB104F 1X4P/FMD	182
03841	DB106F 1X6P/FMD	182

Kód	Model	Strana
03842	DB108F 1X8P/FMD	182
03843	DB112F 1X12P/FMD	182
03844	DB118F 1X18P/FMD	182
03845	DB212F 2X12P/FMD	183
03846	DB312F 3X12P/FMD	183
03850	DB102W 1X2P/SM	184
03851	DB104W 1X4P/SM	184
03852	DB108W 1X8P/SM	184
03853	DB112W 1X12P/SM	184
03854	DB118W 1X18P/SM	184
03859	Z-DB	182
03870	JVL5/2 B16/0,03A	177
03871	JVL5/2 B25/0,03A	177
03970	MAH-1118/A	129
03971	MAH-1218/A	130
03972	MAH-1136/A	129
03973	MAH-1236/A	130
03974	MAH-1158/A	129
03975	MAH-1258/A	130
03985	MAH-1258/A/CP	130
04010	FORT MTH-473/150W-B	159
04011	AVIA MTH-478/400W-B	160
04012	FORT MTH-473/70W-B	159
04013	AVIA MTH-478/250W-B	160
04240	LUVEN MX-216/21W-W	134
04241	LUVEN MX-218/38W-W	134
04260	TUNA S1101-W	137
04265	GAVI LED-2116B-C/M-27	86
04266	GAVI LED-2116B-C-27	86
04273	MAH-1236-EVG/A	130
04280	CERES TL2014-13W-SR	105
04281	PAX TL2016B-8W-SR	105
04282	PAX TL2016B-13W-SR	105
04285	MAH-1236EVG/A-PS	132
04310	PASAT 70-C/M	154
04315	PASAT 150-C/M	154
04325	RESO CTX-KW10-AN	68
04326	RESO CTX-KW10-C	68
04327	RESO CTX-KW10-C/M	68
04340	ASTON DLP-100 218-WH	150
04341	ASTON DLP-100 226-WH	150
04350	SLOT DLP-100G 218-WH	151
04351	SLOT DLP-100G 226-WH	151
04361	ANDES DLP-300G 226-WH	152
04371	NAZAR DLP-200 226-WH	151
04376	GB-2x26W	200
04380	ZEPO LFD-T02-C	100
04381	ZEPO LFD-T02-C/M	100
04385	ZEPO LFD-T02/S-C	100
04386	ZEPO LFD-T02/S-C/M	100
04389	ZEPO LFD-T02/S-BR/M	100
04390	TAXI LED9KW WH-C/M	144
04391	TAXI LED12PR WH-C/M	144
04392	TAXI LED9KW WW-C/M	144
04393	TAXI LED12PR WW-C/M	144
04395	MANGO KF-FBG-20A 25M	191
04396	MANGO KF-FBG-23A 40M	191
04397	MANGO KF-FBG-23A 50M	191
04410	KS6 B1/1	172
04411	KS6 B2/1	172
04412	KS6 B4/1	172
04413	KS6 B6/1	172
04414	KS6 B10/1	172
04415	KS6 B13/1	172
04416	KS6 B16/1	172
04417	KS6 B20/1	172
04418	KS6 B25/1	172
04419	KS6 B32/1	172
04420	KS6 B40/1	172
04431	KS6 C2/1	173

Kód	Model	Strana
04432	KS6 C4/1	173
04433	KS6 C6/1	173
04434	KS6 C10/1	173
04435	KS6 C16/1	173
04436	KS6 C20/1	173
04437	KS6 C25/1	173
04438	KS6 C32/1	173
04439	KS6 C40/1	173
04450	KS6 B6/3	174
04451	KS6 B10/3	174
04452	KS6 B16/3	174
04453	KS6 B20/3	174
04454	KS6 B25/3	174
04455	KS6 B32/3	174
04456	KS6 B40/3	174
04457	KS6 B50/3	174
04458	KS6 B63/3	174
04460	KS6 C6/3	175
04461	KS6 C10/3	175
04462	KS6 C16/3	175
04463	KS6 C20/3	175
04464	KS6 C25/3	175
04465	KS6 C32/3	175
04466	KS6 C40/3	175
04467	KS6 C50/3	175
04468	KS6 C63/3	175
04470	KR6 25/003/2	176
04471	KR6 40/003/2	176
04472	KR6 63/003/2	176
04485	KR6 25/003/4	176
04486	KR6 40/003/4	176
04487	KR6 63/003/4	176
04510	MAH-1118/A-PS	131
04511	MAH-1136/A-PS	131
04512	MAH-1158/A-PS	131
04513	MAH-1218/A-PS	132
04514	MAH-1236/A-PS	132
04515	MAH-1258/A-PS	132
04600	ALDO 118	127
04601	ALDO 218	127
04602	ALDO 136	127
04603	ALDO 236	127
04604	ALDO 158	127
04605	ALDO 258	127
04650	REGIS 418 PAR PT	121
04651	NOTUS 418 PAR NT	125
04652	NOTUS 236 PAR NT	125
04655	REGIS 418-EVG PAR PT	121
04656	NOTUS 418-EVG PAR NT	125
04657	NOTUS 236-EVG PAR NT	125
04671	PORTOS 11	133
04675	LOMA 1000-B	163
04676	SALI 1500-B	163
04679	GORAN CT-J22 C/M	85
04680	DORA LED-J01	143
04681	LINDA LED-J02	143
04682	ALAN LED-J03	143
04683	ALAN LED-J04	143
04684	LICA LED-J04A	143
04685	RODOS CT-DS09-AB	65
04686	RODOS CT-DS09-C	65
04687	RODOS CT-DS09-SN	65
04688	RODOS CT-DT09-AB	66
04689	RODOS CT-DT09-C	66
04690	RODOS CT-DT09-SN	66
04693	NAVI CTX-DS10-AB	66
04694	NAVI CTX-DS10-C	66
04695	NAVI CTX-DS10-SN	66
04697	TOSA CT-DS87-SN	67
04699	GORAN CT-J22 MGR	85

Kód	Model	Strana
04700	RONA CT-AS11-AL	69
04701	TABO CT-AS02-AL	70
04702	PERS CT-DS94-C/W	75
04703	MARIN CT-S80-C	75
04704	MARIN CT-S80-SN	75
04706	QULES CT-DS83-SN	76
04707	GLEN CT-DS82-C	76
04709	VELO CT-AS83-AL	77
04710	MARIN CT-S80-AB	75
04711	GLEN CT-DS82-AB	76
04720	ANO 10	110
04721	ANO 2I	110
04722	ANO 3I	110
04723	ANO 4I	110
04725	HALI 10	110
04726	HALI 2I	110
04727	HALI 3I	110
04728	HALI 4I	110
04729	HALI 30	110
04730	MERA TL-8	104
04731	MERA TL-13	104
04732	MERA TL-21	104
04733	MERA PP	210
04780	PERU 70	199
04781	PERU 150	199
04785	AKRA CT-DS14PS/N	70
04786	AKRA CT-DS14SN/G	70
04790	MIG LED-40	107
04791	MIG LED-4L	107
04795	SONDA EL-1L	112
04796	SONDA EL-2J	112
04797	SONDA EL-3J	112
04798	SONDA EL-4L	112
04805	VOLIN EL-9-B	133
04806	VOLIN EL-9-W	133
04815	MATMA MTH-70	158
04816	MATMA MTH-150	158
04820	RALF DL-220-W	149
04821	VARIO DL-220-W	149
04822	BEN DL-220-W	150
04825	VOLKER 418 PT	122
04826	TOKEN 418 NT	126
04827	TOKEN 236 NT	126
04830	GRAF 414 PT-EVG	123
04832	XEDOS 414 NT-EVG	124
04835	REVA MTH-70/S	158
04836	REVA MTH-70/A	159
04838	REVA MTH-150/S	158
04839	REVA MTH-150/A	159
04841	ADAMO MTH-250/S	160
04842	ADAMO MTH-400/S	160
04845	ADAMO MTH-250/A	161
04846	ADAMO MTH-400/A	161
04851	VIGA DL-280	135
04852	VIGA DL-28L	135
04863	GRIP W/US	194
04864	STAN GP	194
04865	VITAM EL-60	141
04870	MORO DL-35	146
04872	CELT TL2050-13W-SR	106
04900	BRAVA MTH-70-W	153
04901	BRAVA MTH-150-W	153
04905	SELVA MTH-150-W	153
04908	MEDIA MTH-70-W	154
04909	MEDIA MTH-150-W	154
04910	MEDIA MTH-70-GR	154
04911	MEDIA MTH-150-GR	154
04920	BONI DL-RD50-PS/G	81
04921	BONI DL-RD50-PG/N	81
04922	BONI DL-RD50-SN/G	81



Kód	Model	Strana
04923	BONI DL-RD50-SN/N	81
04930	VABI DL-RS50-C	82
04931	VABI DL-RS50-C/M	82
04942	MAYOR DLP-226-W	148
04945	EDEN EL-25	117
04960	MATEO DLP-150-GR	152
04961	MATEO DLP-250-GR	152
04962	MATEO DLP-350-GR	152
04963	MATEO DLP-450-GR	152
04965	DAVID CTX-20-SN	71
04970	ZEW EL-235U	142
04971	ZEW EL-235J	142
04977	SEDNA CTX-A20C/M	84
04978	SEDNA CTX-A20AB	84
04980	TURO MTH-70	147
04981	TURO MTH-150	147
04990	VISTO DL-2130	134
04991	VISTO DL-750	134
07010	GORDO DL-LED14	145
07011	SHARK EL-60	141
07012	GORDO DL-LED14L	145
07015	MARC DL-60	136
07020	FAVOR DL-60	136
07025	TURK DL-60	140
07079	BART EL-135	142
07080	BART EL-235	142
07081	BART EL-160	142
07082	BART EL-260	142
07083	BART EL-140	142
07085	MOLI EL-10	111
07086	MOLI EL-2I	111
07087	MOLI EL-30	111
07088	MOLI EL-4I	111
07090	OFRA TL-218A-W	128
07091	OFRA TL-236A-W	128
07092	OFRA TL-218A-SR	128
07093	OFRA TL-236A-SR	128
07095	OFRA TL-218B-W	128
07096	OFRA TL-236B-W	128
07097	OFRA TL-218B-SR	128
07098	OFRA TL-236B-SR	128
07110	GINA EL-1L	111
07111	GINA EL-2I	111
07112	GINA EL-3I	111
07113	GINA EL-3L	111
07114	GINA EL-4I	111
07120	LINEAL 3LED12	101
07130	AMY EL-140	109
07131	AMY EL-T240	109
07132	AMY EL-U240	109
07140	AKVEN EL-35-GN	118
07150	SUZI HR-60-SR	93
07151	SUZI HR-60-B	93
07152	SUZI HR-60-BL	93
07153	SUZI HR-60-PK	93
07160	BRAS KT-18-SR	94
07170	BERG DL-350	146
07171	BERG DL-35L	146
07180	BS-1 4-22W	200
07181	BS-2 4-65W	200
07190	KIRA DL-75	138
07191	KIRA DL-29	138
07195	XARD DL-40	147
07200	MIRON KT040-GF/T	93
07210	NIKOR DLP-60-W	148
07211	NIKOR DLP-75-W	148
07215	BRUNO EL-13-B	162
07230	ZENA EL-4	107
07231	ZENA EL-2	107
07235	VANTI EL-1440	108

Kód	Model	Strana
07236	LEVEL EL-150L	108
07240	TETRIS 2LED15	101
07241	TETRIS LED15	101
07250	MEBA TL-218	127
07251	MEBA TL-236	127
07252	MEBA TL-218/OP	127
07253	MEBA TL-236/OP	127
07270	GANNA 35	199
07271	GANNA 70	199
07272	GANNA 150	199
07280	ROGER DL-LED12	145
07281	ROGER DL-2LED6	145
07290	VOLCANO LED-BL 5M	102
07291	VOLCANO LED-RE 5M	102
07292	VOLCANO LED-GN 5M	102
07293	VOLCANO LED-Y 5M	102
07294	VOLCANO LED-CW 5M	102
07295	VOLCANO LED-WW 5M	102
07296	VOLCANO LED-OR 5M	102
07300	RICO LED 4-6W	195
07301	RICO LED 15-24W	195
07302	RICO LED 10-18W	195
07303	RICO LED 9-12W	195
07310	IVO DL-380	135
07311	IVO DL-38L	135
07340	FRODO DL-60	140
07350	KSENIA DL-POWER LED	88
07351	FERRA DL-3POWER LED	89
07360	RADAN CT-DTO50	62
07361	RADAN CT-DTL50	62
07362	RADAN CT-DSO50	61
07363	RADAN CT-DSL50	61
07370	TESON AL-DTO50	79
07371	TESON AL-DTL50	79
07372	TESON AL-DSO50	78
07373	TESON AL-DSL50	78
07380	REA LED12 E14-Y	30
07381	REA LED12 E14-RE	30
07382	REA LED12 E14-BL	30
07383	REA LED12 E14-GN	30
07384	REA LED12 E14-WW	30
07390	ODA LED12 E27-Y	30
07391	ODA LED12 E27-RE	30
07392	ODA LED12 E27-BL	30
07393	ODA LED12 E27-GN	30
07394	ODA LED12 E27-WW	30
07420	FAUST KT-455	98
07421	FAUST DL-260	98
07422	FAUST DL-480	98
07430	ESG-75 9W GX53	46
07440	KREON TL-GX53	98
07450	BALTA -24W 118MM	45
07460	JEN CE-82-B BALTA	162
07470	VERA LED EL-18L-UP	116
07471	VERA LED EL-22L-UP	116
07472	VERA LED EL-30	116
07473	VERA LED EL-50	116
07474	VERA LED EL-85	116
07490	ESPERO MTH-1150-GR	155
07491	ESPERO MTH-2150-GR	155
07492	ESPERO MTH-3150-GR	155
07493	ESPERO MTH-4150-GR	155
07500	SORIN LED EL-21L-UP	116
07501	SORIN LED EL-32I-UP	116
07502	SORIN LED EL-40	116
07503	SORIN LED EL-70	116
07510	ALTIMA EL-24L-UP	117
07511	ALTIMA EL-45	117
07512	ALTIMA EL-110	117
07520	SAXO LED KT-58	96

Kód	Model	Strana
07530	ENEA EL-17A-SR	156
07531	ENEA TR 1M	157
07532	ENEA TR 2M	157
07533	ENEA PR	157
07550	JUTA LED30 E14-WW	29
07551	JUTA LED30 E27-WW	29
07552	LAB LED30 E14-WW	29
07553	LAB LED30 E27-WW	29
07560	ZARA HR-40-SR	92
07561	ZARA HR-40-B	92
07562	ZARA HR-40-BL	92
07563	ZARA HR-40-OR	92
07580	LUCA LED48 E27-WW	28
07581	LUCA LED48 E14-WW	28
07590	KALI LED36 E27-WW	28
07600	EBOS LED12/JC	97
07610	PACO LED45-B	161
07620	PACO LED28-B	161
07630	2U XEU-9W E14	39
07631	2U XEU-11W E14	39
07632	2U XEU-15W E27	39
07633	2U XEU-18W E27	39
07640	3U XEU-9W E14	39
07641	3U XEU-11W E14	39
07642	3U XEU-15W E14	39
07643	3U XEU-18W E27	39
07644	3U XEU-20W E27	39
07645	3U XEU-24W E27	39
07650	POWER-3LED MR16-CW	32
07651	POWER-3LED MR16-WW	32
07660	POWER-3LED GU10-CW	34
07661	POWER-3LED GU10-WW	34
07670	LED48 GU10-WW	35
07671	LED48 GU10-CW	35
07680	LED48 MR16-WW	32
07681	LED48 MR16-CW	32
07690	MERGE JQ-L	201
07691	MERGE JQ-O	201
07700	SEDNA POWER LED	88
07710	GORAN POWER LED	87
07720	RESO POWER LED	87
07740	KONRAT DL-LED24A	144
07741	KONRAT DL-LED24B	144
07750	ISTRO LED-BL 5M	102
07751	ISTRO LED-CW 5M	102
07752	ISTRO LED-GN 5M	102
07753	ISTRO LED-OR 5M	102
07754	ISTRO LED-RE 5M	102
07755	ISTRO LED-WW 5M	102
07756	ISTRO LED-Y 5M	102
07760	CARI LED18 KT-87	97
07770	DAO QDL-7W E27	43
07771	DAO QDL-7W E14	43
07780	DAO QDL-11W E27	43
07790	DAO GBL-7W E27	43
07791	DAO GBL-7W E14	43
07800	TRETO LED	196
07820	LED60 E14-CW	31
07821	LED60 E14-WW	31
07822	LED60 E27-CW	31
07823	LED60 E27-WW	31
07830	LED60 GU10-WW	35
07831	LED60 GU10-CW	35
07840	LED60 MR16-WW	33
07841	LED60 MR16-CW	33
07860	EURO MTH-250-16PC	155
07861	EURO MTH-400-16PC	155
07862	EURO MTH-250-22PC	155
07863	EURO MTH-400-22PC	155
07864	EURO MTH-250-21AL	156

Kód	Model	Strana
07865	EURO MTH-400-21AL	156
07870	ROPE-NT 150	212
07881	DOMI EB3-W	203
07882	DOMI EB230-W	203
07890	NOTUS 218 PAR NT	125
07891	NOTUS 218-EVG PAR NT	125
07900	KIRA DL-75B	138
07901	KIRA DL-29B	138
07920	CRESSIDA NB40-W	120
10302	MR-16C 20W36 PREMIUM	54
10303	MR-16C 20W60 PREMIUM	54
10306	MR-16C 35W36 PREMIUM	54
10307	MR-16C 35W60 PREMIUM	54
10311	MR-16C 50W40 PREMIUM	54
10312	MR-16C 50W60 PREMIUM	54
10363	MR-11C 20W30 PREMIUM	53
10364	MR-11C 35W30 PREMIUM	53
10400	J-100W 78MM PREMIUM	51
10401	J-150W 78MM PREMIUM	51
10404	J-60W 78MM PREMIUM	51
10410	J-100W 118MM PREMIUM	51
10411	J-150W 118MM PREMIUM	51
10412	J-200W 118MM PREMIUM	51
10414	J-300W 118MM PREMIUM	51
10416	J-500W 118MM PREMIUM	51
10418	J-1000W 189MM PREMIUM	51
10419	J-1500W 254MM PREMIUM	51
10432	JC-10W4/EK BASIC	52
10433	JC-20W4/EK BASIC	52
10434	JC-35W4/EK BASIC	52
10500	SUPERSHAPE BH4-9X E14/K	37
10501	SUPERSHAPE BH4-9X E27/K	37
10502	SUPERSHAPE BH4-11X E14/K	37
10503	SUPERSHAPE BH4-11X E27/K	37
10504	SUPERSHAPE BH4-15W E27/K	37
10505	SUPERSHAPE BH4-20W E27/K	37
10506	SUPERSHAPE BH5-24W E27/K	37
10612	SUPERGLOB XEU23-15G1 E27/K	45
10615	GLOB XEU48-15G E27/K	44
10616	GLOB XEU48-20G E27/K	44
10620	SUPERGLOB XEU38-20G E27/K	45
10630	3U SLIM XEU23-9UC E14/K	40
10631	3U SLIM XEU23-11UC E14/K	40
10632	3U SLIM XEU23-15UC E14/K	40
10640	DART CDL-11S E27/K	42
10641	DART CDL-7 E14/K	42
10645	2U SLIM XEU23-7W E14/K	40
10661	T2U-18W/K	48
10662	T2U-26W/K	48
10671	T1U-9W/K	48
10672	T1U-11W/K	48
10680	4U XEU48-9U E27/K	41
10681	4U XEU48-11U E27/K	41
10682	4U XEU48-13U E27/K	41
10683	4U XEU48-15U E27/K	41
10684	4U XEU48-18U E27/K	41
10685	4U XEU48-20U E27/K	41
10700	J-100W 78MM/EK BASIC	51
10701	J-150W 78MM/EK BASIC	51
10712	J-200W 118MM/EK BASIC	51
10714	J-300W 118MM/EK BASIC	51
10716	J-500W 118MM/EK BASIC	51
10720	JC-5W G4 PREMIUM	52
10722	JC-10W G4 PREMIUM	52
10724	JC-20W G4 PREMIUM	52
10726	JC-35W G4 PREMIUM	52
10730	JC-20W GY6.35 PREMIUM	53
10732	JC-35W GY6.35 PREMIUM	53
10734	JC-50W GY6.35 PREMIUM	53
10761	JDR+A20W36C PREMIUM	52

Kód	Model	Strana
10763	JDR+A35W36C PREMIUM	52
10765	JDR+A50W36C PREMIUM	52
10767	JDR+A20W60C PREMIUM	52
10769	JDR+A35W60C PREMIUM	52
10771	JDR+A50W60C PREMIUM	52
10814	JDR+A20W60C/EK BASIC	52
10815	JDR+A35W60C/EK BASIC	52
10816	JDR+A50W60C/EK BASIC	52
10852	AR-111 35W45	54
10857	AR-111 50W45	54
10870	G9-25W	51
10871	G9-40W	51
10872	G9-60W	51
10930	T4-8W 4000K	50
10931	T4-12W 4000K	50
10932	T4-16W 4000K	50
10933	T4-20W 4000K	50
11163	IKER NL4631-WHITE	119
11173	KODI NL4636-WHITE	119
12502	MR-16C 20W36/EK BASIC	54
12503	MR-16C 20W60/EK BASIC	54
12506	MR-16C 35W36/EK BASIC	54
12507	MR-16C 35W60/EK BASIC	54
12511	MR-16C 50W40/EK BASIC	54
12512	MR-16C 50W60/EK BASIC	54
12517	MR-11C 20W30/EK BASIC	53
12518	MR-11C 35W30/EK BASIC	53
12550	R39 30W E14/K	50
12551	R50 25W E14/K	50
12552	R50 40W E14/K	50
12553	R50 60W E14/K	50
12554	R63 40W E27/K	50
12555	R63 60W E27/K	50
12600	SPIRAL ETU-MSS 7W E14/K	38
12605	SPIRAL ETU-MSS 9W E27/K	38
12606	SPIRAL ETU-MSS 11W E27/K	38
12607	SPIRAL ETU-MSS 15W E27/K	38
12615	SUPERSLIM ETU-M9W E27/K	40
12616	SUPERSLIM ETU-M11W E27/K	40
12617	SUPERSLIM ETU-M15W E27/K	40
12618	SUPERSLIM ETU-M20W E27/K	40
12620	LED20 GU10-CW	36
12621	LED20 GU10-GN	36
12622	LED20 GU10-BL	36
12623	LED20 GU10-Y	36
12624	LED20 GU10-RE	36
12625	LED20 GU10-WW	36
12630	LED12 GU10-CW	36
12640	SENSORSPIRAL ETU-CSS 11W E27/K	38
12641	SENSORSPIRAL ETU-CSS 20W E27/K	38
12645	SPIRAL ETU-SS 24W E27/K	38
12650	DD-16W/2P 3500K	47
12660	DD-16W/4P 3500K	47
12661	DD-21W/4P 3500K	47
12662	DD-28W/4P 3500K	47
12663	DD-38W/4P 3500K	47
12670	FCL-22W/4P 2700K	47
12690	GLOB XEU48-9XG E27/K	44
12691	GLOB XEU48-11XG E27/K	44
12695	MINIGLOB XEU48-9XG E14/K	44
12696	MINIGLOB XEU48-11XG E14/K	44
12697	4U MINI XEU48-9X E14/K	41
12698	4U MINI XEU48-11X E14/K	41
12700	G9-25W/EK BASIC	51
12701	G9-40W/EK BASIC	51
12702	G9-60W/EK BASIC	51
12705	MOSKITO T5	118
12710	T5-8W 2700K/65	49
12711	T5-13W 2700K/65	49
12712	T5-14W 2700K/82	49

Kód	Model	Strana
12713	T5-21W 2700K/82	49
12715	T5-8W 4000K/65	49
12716	T5-13W 4000K/65	49
12717	T5-14W 4000K/82	49
12718	T5-21W 4000K/82	49
12731	CDL-7W GU10	46
12732	CDL-9W GU10	46
12750	MHR-70W/3000K	55
12751	MHR-150W/3000K	55
12755	MHE-250W/4200K	55
12756	MHE-400W/4200K	55
12760	LED20 MR16-CW	33
12761	LED20 MR16-WW	33
12765	LED20 MR16-GN	33
12766	LED20 MR16-BL	33
12767	LED20 MR16-Y	33
12768	LED20 MR16-RE	33
12800	POWER-LED GU10-WW	34
12801	POWER-LED GU10-CW	34
12810	POWER-LED MR16-WW	31
12811	POWER-LED MR16-CW	31
12840	FON CDL-7W E14	42
12841	FON CDL-9W E14	42
12842	FON CDL-7W E27	42
12843	FON CDL-9W E27	42
12850	FON GBL-11W E27	42
70402	OTON RT060-1011K	197
70403	OTON RT100-1011K	197
70406	OTON RT200-1011K	197
70407	OTON RT250-1011K	197
70408	OTON RT300-1011K	197
70426	OTON RT150-1011K	197
70470	MB18/20	198
70471	MB36/40	198
70472	MB58	198
70480	BL-118H-EVG	198
70481	BL-136H-EVG	198
70482	BL-158H-EVG	198
70483	BL-218H-EVG	198
70484	BL-236H-EVG	198
70485	BL-258H-EVG	198
70522	MILO 7040T	139
70523	MILO 7040TP	139
70524	HERMI 7063NB	139
70525	INES 7061N	138
70526	INES 7061NC	138
70527	7070T	137
70710	TIVA 1130 DDR/ML-SN	113
70711	TIVA 1130 DDR/ML-DB	114
70712	TIVA 1130 DDR/ML-MH	114
70717	TIVA 1130 DDR/ML-OL	115
70720	TIVA 1030 SDR/ML-SN	113
70721	TIVA 1030 SDR/ML-DB	114
70722	TIVA 1030 SDR/ML-MH	114
70727	TIVA 1030 SDR/ML-OL	115
70730	TIVA 1030 MDR/ML-SN	113
70731	TIVA 1030 MDR/ML-DB	114
70732	TIVA 1030 MDR/ML-MH	114
70737	TIVA 1030 MDR/ML-OL	115
70740	TIVA 1030 1/2DR/ML-SN	113
70741	TIVA 1030 1/2DR/ML-DB	114
70742	TIVA 1030 1/2DR/ML-MH	114
70747	TIVA 1030 1/2DR/ML-OL	115
70756	ARDEA 1130 DG/ML-SR	113
70761	ARDEA 1030 SG/ML-SR	113
70766	ARDEA 1030 MG/ML-SR	113
70771	ARDEA 1030 1/2G/ML-SR	113
70782	ARDEA 1130 D/ML-BI	112
70784	ARDEA 1030 S/ML-BI	112
70786	ARDEA 1030 M/ML-BI	112

Kód	Model	Strana
70788	ARDEA 1030 1/2/ML-BI	112
70793	SYLENI 1130 SY/ML-SR	115
70795	SYLENI 1030 MY/ML-SR	115
70900	WIR WK-10	188
70901	WIR WK-12	188
70903	WIR WK-15	188
70910	CYKLON EOL100	187
70911	CYKLON EOL100B	187
70915	CYKLON EOL120	187
70916	CYKLON EOL120B	187
70920	CYKLON EOL150	188
70921	CYKLON EOL150B	188
70926	TWISTER AOL100B	186
70936	CYKLON EOL100HT	187
70937	CYKLON EOL100P	187
70938	CYKLON EOL100T	187
70941	CYKLON EOL120HT	187
70942	CYKLON EOL120P	187
70943	CYKLON EOL120T	187
70947	CYKLON EOL150P	188
70948	CYKLON EOL150T	188
70953	TWISTER AOL100T	186
70956	TWISTER AOL120B	186
70960	TWISTER AOL120T	186
70961	WIR ZL100	189
72109	HLDR-GX5.3	207
72111	PRO DR-16B-C	89

Kód	Model	Strana
72114	GRID-ZW3-L150	221
72115	GRID-ZW3-L500	221
72121	SPR.CT-21/MR16	209
72122	SPR.CT-21/MR11	209
72126	GLASS-ZW3-L150	221
72139	PRO DR-16B-C/M	89
72159	GLASS-CE-81	219
72160	GLASS-CE-81-Y	220
72163	GLASS-CE-82	220
72164	GLASS-CE-82-Y	220
72165	GLASS-SL-150R-F	220
72166	GLASS-SL-300R-F	221
72186	GLASS-SALI	219
72187	GLASS-LOMA	219
72192	PRO DR-16B-BR/M	89
72277	SPR.CTC-55/MR11	209
72278	SPR.CTC-55/MR16	209
72279	SPR.CTC-31/MR16	209
72280	GL-MAH-1118/A-PC	214
72281	GL-MAH-1136/A-PC	215
72282	GL-MAH-1158/A-PC	215
72283	GL-MAH-1218/A-PC	216
72284	GL-MAH-1236/A-PC	216
72285	GL-MAH-1258/A-PC	217
72304	CL-MAH/A	214
72306	GL-MTH-473/150W	218
72307	GL-MTH-478/400W	218

Kód	Model	Strana
72308	CL-MAH/A-INOX	214
72309	GL-S1101	217
72333	CLP-REGIS/PT	212
72351	GL-ANO/CL+FR	210
72352	GL-HALI/CL+FR	210
72356	GL-PASAT 70	217
72357	GL-PASAT 150	218
72359	FSL F4 T5/BL	211
72362	GL-MAH-1118/A-PS	214
72363	GL-MAH-1218/A-PS	216
72364	GL-MAH-1136/A-PS	215
72365	GL-MAH-1236/A-PS	216
72366	GL-MAH-1158/A-PS	215
72367	GL-MAH-1258/A-PS	217
72368	GL-MATMA 70/150	218
72372	GL-ADAMO 250/400	219
72382	GL-EDEN	211
72383	CLP-VOLKER/PT	212
72386	GL-AMY EL	211
72391	GL-MEBA TL-218/PMMA	213
72392	GL-MEBA TL-236/PMMA	213
72393	GL-GINA EL	211
72396	GL-MEBA TL-218/OP	213
72397	GL-MEBA TL-236/OP	213
72398	COV-MEBA TL	212

www.kanlux.sk

**Kanlux**



Svetelné zdroje

# LUCA LED48

Svetelný zdroj LED



**Kanlux**



■ LUCA LED48 E14-WW



■ LUCA LED48 E27-WW

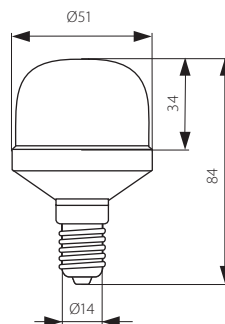

LUCA LED48 E14-WW

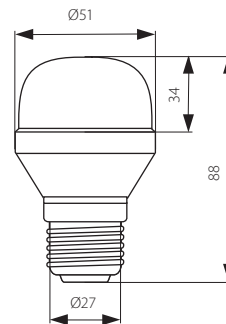

LUCA LED48 E27-WW



<b>Kanlux</b>		EAN 				DKC SK bez DPH
<b>NEW</b> LUCA LED48 E14-WW	07581	5905339075819	teplá biela	E14	48	17,76 €
<b>NEW</b> LUCA LED48 E27-WW	07580	5905339075802	teplá biela	E27	52	17,76 €

230V~	50Hz								
		3	48 LED	2700-3000	170	≥60	35000	1/6/36	

# KALI LED36 E27-WW

Svetelný zdroj LED



■ KALI LED36 E27-WW

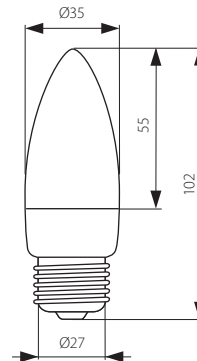

<b>Kanlux</b>		EAN 		DKC SK bez DPH
<b>NEW</b> KALI LED36 E27-WW	07590	5905339075901	teplá biela	17,76 €

230V~	50Hz										
		2	36 LED	E27	2700-3000	125	≥60	35000	1/8/48	40	

Svetelný zdroj LED

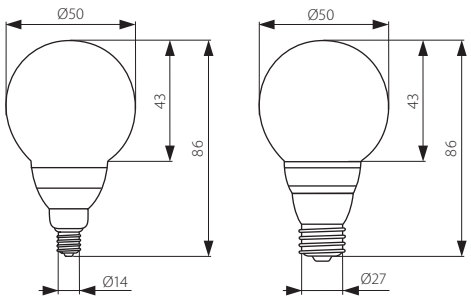

LAB LED30 E14-WW      LAB LED30 E27-WW



■ LAB LED30 E14-WW      ■ LAB LED30 E27-WW

<b>NEW</b>	<b>Kanlux</b>	<b>Kanlux</b>	EAN		teplá biela teplá biela		[g]	DKC SK bez DPH	
	LAB LED30 E14-WW	07552	5905339075529						E14
<b>NEW</b>	LAB LED30 E27-WW	07553	5905339075536				E27	40	20,89 €

220-240V~    50/60Hz    2    30 LED    Tc [K] 3000-3300    100    Ra ≥65    35000 [h]    1/-/50    CE

Svetelný zdroj LED

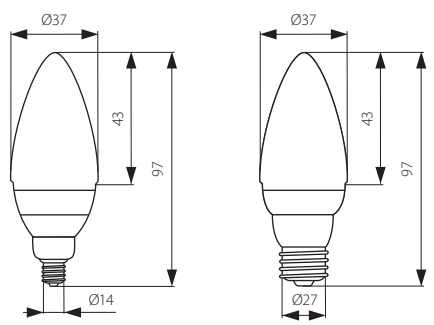

JUTA LED30 E14-WW      JUTA LED30 E27-WW



■ JUTA LED30 E14-WW      ■ JUTA LED30 E27-WW

<b>NEW</b>	<b>Kanlux</b>	<b>Kanlux</b>	EAN		teplá biela teplá biela		[g]	DKC SK bez DPH	
	JUTA LED30 E14-WW	07550	5905339075505						E14
<b>NEW</b>	JUTA LED30 E27-WW	07551	5905339075512				E27	40	20,89 €

220-240V~    50/60Hz    2    30 LED    Tc [K] 3000-3300    100    Ra ≥65    35000 [h]    1/-/50    CE

# ODA LED12 E27

**Kanlux**

Svetelný zdroj LED



■ ODA LED12 E27-WW ■ ODA LED12 E27-Y ■ ODA LED12 E27-GN ■ ODA LED12 E27-BL ■ ODA LED12 E27-RE

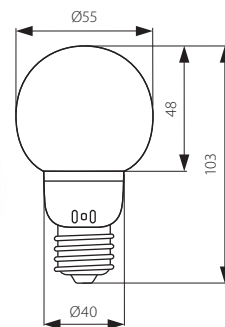

	<b>Kanlux</b>	<b>Kanlux</b>	EAN		[lm]	Ra	Tc [K]	DKC SK bez DPH
<b>NEW</b>	ODA LED12 E27-WW	07394	5905339073945	teplá biela	20	≥75	2700-3200	6,19 €
<b>NEW</b>	ODA LED12 E27-Y	07390	5905339073907	žltá	-	-	-	6,19 €
<b>NEW</b>	ODA LED12 E27-GN	07393	5905339073938	zelená	-	-	-	6,19 €
<b>NEW</b>	ODA LED12 E27-BL	07392	5905339073921	modrá	-	-	-	6,19 €
<b>NEW</b>	ODA LED12 E27-RE	07391	5905339073914	červená	-	-	-	6,19 €



# REA LED12 E14

Svetelný zdroj LED



■ REA LED12 E14-WW ■ REA LED12 E14-Y ■ REA LED12 E14-GN ■ REA LED12 E14-BL ■ REA LED12 E14-RE

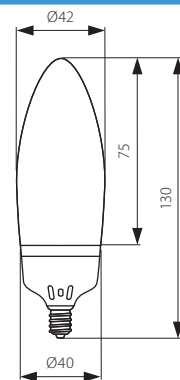

	<b>Kanlux</b>	<b>Kanlux</b>	EAN		[lm]	Ra	Tc [K]	DKC SK bez DPH
<b>NEW</b>	REA LED12 E14-WW	07384	5905339073846	teplá biela	20	≥75	2700-3200	6,19 €
<b>NEW</b>	REA LED12 E14-Y	07380	5905339073808	žltá	-	-	-	6,19 €
<b>NEW</b>	REA LED12 E14-GN	07383	5905339073839	zelená	-	-	-	6,19 €
<b>NEW</b>	REA LED12 E14-BL	07382	5905339073822	modrá	-	-	-	6,19 €
<b>NEW</b>	REA LED12 E14-RE	07381	5905339073815	červená	-	-	-	6,19 €



Svetelný zdroj LED

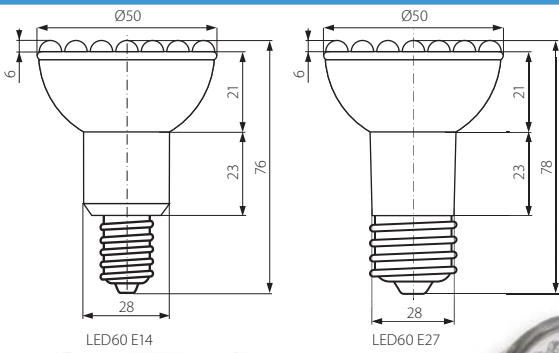

LED60 E14

LED60 E27



- LED60 E27-CW
- LED60 E27-WW

- LED60 E14-CW
- LED60 E14-WW

	<b>Kanlux</b>	<b>Kanlux</b>	EAN			Tc [K]	DKC SK bez DPH
<b>NEW</b>	LED60 E14-CW	07820	5905339078209	studená biela	E14	6000-7500	10,25 €
<b>NEW</b>	LED60 E14-WW	07821	5905339078216	teplá biela	E14	3000-3300	10,25 €
<b>NEW</b>	LED60 E27-CW	07822	5905339078223	studená biela	E27	6000-7500	10,25 €
<b>NEW</b>	LED60 E27-WW	07823	5905339078230	teplá biela	E27	3000-3300	10,25 €

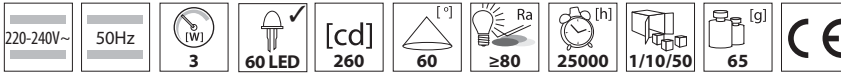

## POWER-LED MR16

Svetelný zdroj POWER LED

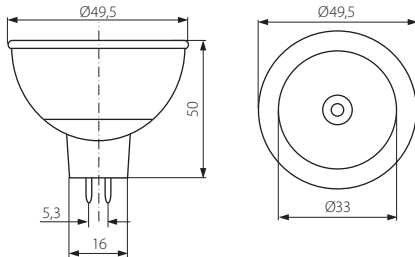

- POWER-LED MR16-CW
- POWER-LED MR16-WW

	<b>Kanlux</b>	<b>Kanlux</b>	EAN		Tc [K]	DKC SK bez DPH
<b>NEW</b>	POWER-LED MR16-CW	12811	5905339128119	studená biela	5500-6500	11,07 €
	POWER-LED MR16-WW	12810	5905339128102	teplá biela	2700-3200	10,75 €

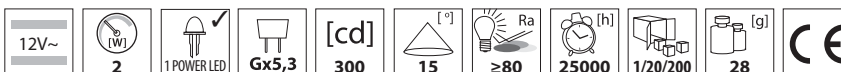

# POWER-3LED MR16

Svetelný zdroj POWER LED



**Kanlux**

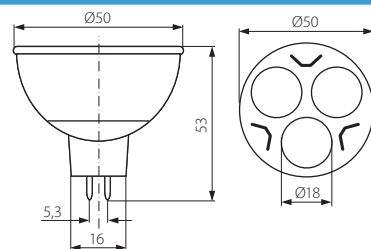

- POWER-3LED MR16-CW
- POWER-3LED MR16-WW



<b>Kanlux</b>	<b>Kanlux</b>	EAN		Tc (K)	DKC SK bez DPH					
NEW POWER-3LED MR16-CW	07650	5905339076502	studená biela	5500-6500	15,17 €					
NEW POWER-3LED MR16-WW	07651	5905339076519	teplá biela	2700-3200	15,17 €					
12V~	3	3 POWER LED	GU5,3	[cd] 450	[°] 20	Ra ≥80	20000 [h]	1/6/120	60 [g]	CE

# LED48 MR16

Svetelný zdroj LED

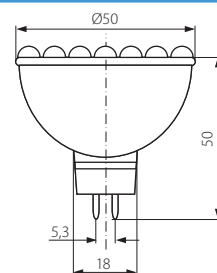

- LED48 MR16-CW
- LED48 MR16-WW



<b>Kanlux</b>	<b>Kanlux</b>	EAN		Tc (K)	DKC SK bez DPH					
NEW LED48 MR16-CW	07681	5905339076816	studená biela	5000-7500	7,37 €					
NEW LED48 MR16-WW	07680	5905339076809	teplá biela	2700-3200	7,37 €					
12V~	2,5	48 LED	GU5,3	[cd] 205	[°] 120	Ra ≥80	25000 [h]	1/10/200	55 [g]	CE





Svetelný zdroj LED

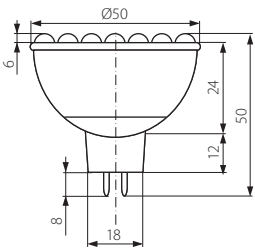

- LED60 MR16-CW
- LED60 MR16-WW

<b>Kanlux</b>	<b>Kanlux</b>	EAN		Tc [K]	DKC SK bez DPH					
NEW LED60 MR16-CW	07841	5905339078414	studená biela	6000-7500	10,25 €					
NEW LED60 MR16-WW	07840	5905339078407	teplá biela	3000-3300	10,25 €					
12V~	3,9	60 LED	GU5,3	[cd] 260	60	Ra ≥80	25000 [h]	1/10/200	60 [g]	CE

Svetelný zdroj LED

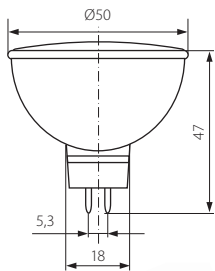

- LED20 MR16-CW
- LED20 MR16-WW
- LED20 MR16-Y
- LED20 MR16-GN
- LED20 MR16-GN
- LED20 MR16-RE

<b>Kanlux</b>	<b>Kanlux</b>	EAN		Tc [K]	[cd]	Ra	DKC SK bez DPH	
LED20 MR16-CW	12760	5905339127600	studená biela	5000-7500	200	≥70	6,47 €	
LED20 MR16-WW	12761	5905339127617	teplá biela	2700-3300	180	≥70	6,47 €	
LED20 MR16-Y	12767	5905339127679	žltá	-	60	-	5,18 €	
LED20 MR16-GN	12765	5905339127655	zelená	-	80	-	5,18 €	
LED20 MR16-BL	12766	5905339127662	modrá	-	220	-	5,18 €	
LED20 MR16-RE	12768	5905339127686	červená	-	60	-	5,18 €	
12V~	1,5	20 LED	GU5,3	[°]	15	1/10/200	40 [g]	CE

# POWER-LED GU10

**Kanlux**

Svetelný zdroj POWER LED

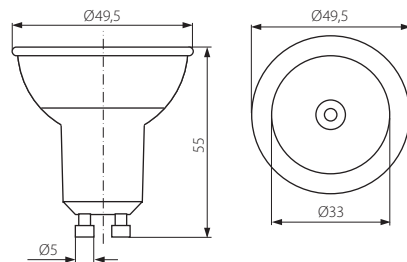

- POWER-LED GU10-CW
- POWER-LED GU10-WW

NEW	<b>Kanlux</b>		EAN			DKC SK bez DPH
	POWER-LED GU10-CW	12801	5905339128010	studená biela	5500-6500	
	POWER-LED GU10-WW	12800	5905339128003	teplá biela	2700-3200	10,75 €

230V~				[cd]					
3	1 POWER LED	GU10	300	15	≥80	25000	1/20/200	34	

# POWER-3LED GU10

Svetelný zdroj POWER LED

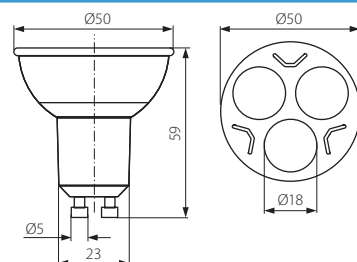

- POWER-3LED GU10-CW
- POWER-3LED GU10-WW

NEW	<b>Kanlux</b>		EAN			DKC SK bez DPH
	POWER-3LED GU10-CW	07660	5905339076601	studená biela	5500-6500	
NEW	POWER-3LED GU10-WW	07661	5905339076618	teplá biela	2700-3200	15,17 €

220-240V~	50/60Hz				[cd]					
3	3 POWER LED	GU10	450	20	≥80	20000	1/6/120	60		



Svetelný zdroj LED

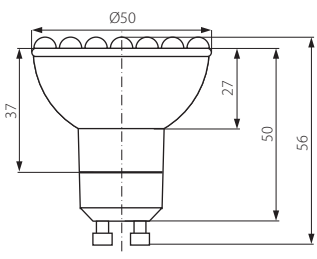

- LED48 GU10-CW
- LED48 GU10-WW

<b>Kanlux</b>	<b>Kanlux</b>	EAN		<b>Tc [K]</b>	DKC SK bez DPH
<b>NEW</b> LED48 GU10-CW	07671	5905339076717	studená biela	5500-7500	7,37 €
<b>NEW</b> LED48 GU10-WW	07670	5905339076700	teplá biela	2700-3200	7,37 €
220-240V~	50Hz				
2,5	48 LED	GU10	205	120	
	≥80		1/10/100		60

Svetelný zdroj LED

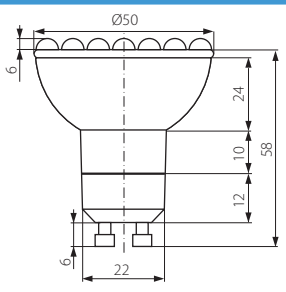

- LED60 GU10-CW
- LED60 GU10-WW

<b>Kanlux</b>	<b>Kanlux</b>	EAN		<b>Tc [K]</b>	DKC SK bez DPH
<b>NEW</b> LED60 GU10-CW	07831	5905339078315	studená biela	6000-7500	10,25 €
<b>NEW</b> LED60 GU10-WW	07830	5905339078308	teplá biela	3000-3300	10,25 €
220-240V~	50Hz				
3	60 LED	GU10	260	60	
	≥80		25000		1/10/100
	62				

# LED GU10

**Kanlux**

Svetelný zdroj LED

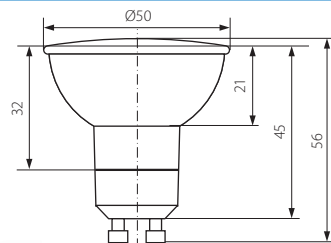

■ LED12 GU10-CW

■ LED20 GU10-CW  
■ LED20 GU10-WW



Kanlux	Kanlux	EAN
LED12 GU10-CW	12630	5905339126306
LED20 GU10-CW	12620	5905339126207
LED20 GU10-WW	12625	5905339126252

- studená biela
- studená biela
- teplá biela



5000-7500  
5000-7500  
2700-3300

[cd]

120  
200  
180



46  
48  
48

DKC SK bez DPH

5,11 €  
7,80 €  
7,80 €



■ vo svetelnom zdroji LED12 GU10-CW je 12 LED diód, vo svetelnom zdroji LED20 GU10 je 20 LED diód

# LED20 GU10

Svetelný zdroj LED

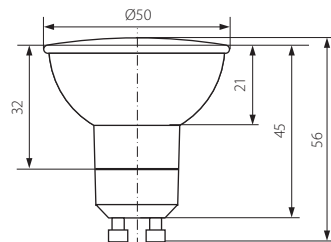

■ LED20 GU10-Y

■ LED20 GU10-GN

■ LED20 GU10-BL

■ LED20 GU10-RE

Kanlux	Kanlux	EAN
LED20 GU10-Y	12623	5905339126238
LED20 GU10-GN	12621	5905339126214
LED20 GU10-BL	12622	5905339126221
LED20 GU10-RE	12624	5905339126245



žltá  
zelená  
modrá  
červená

[cd]

60  
180  
80  
60

DKC SK bez DPH

6,27 €  
6,27 €  
6,27 €  
6,27 €

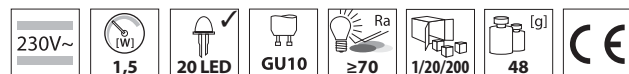



Kompaktná žiarivka

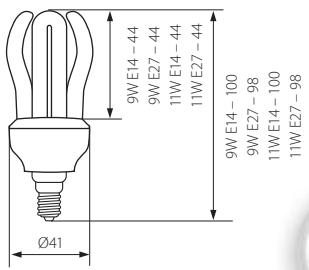

■ SUPERSHAPE BH4-9X E27/K

■ SUPERSHAPE BH4-11X E27/K

■ SUPERSHAPE BH4-9X E14/K

■ SUPERSHAPE BH4-11X E14/K

Kanlux	Kanlux	EAN	[W]	[lm]	[g]	DKC SK bez DPH
SUPERSHAPE BH4-9X E14/K	10500	5905339105004	9	E14 430	50	5,68 €
SUPERSHAPE BH4-9X E27/K	10501	5905339105011	9	E27 430	50	5,68 €
SUPERSHAPE BH4-11X E14/K	10502	5905339105028	11	E14 550	55	5,68 €
SUPERSHAPE BH4-11X E27/K	10503	5905339105035	11	E27 550	55	5,68 €

220-240V~ 50/60Hz Tc [K] 2700 Ra ≥80 A-EI 8000 1/10/100 CE

## SUPERSHAPE BH

Kompaktná žiarivka

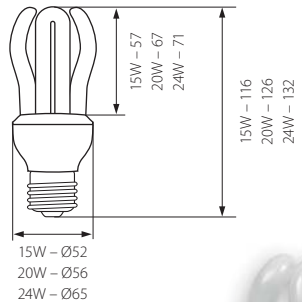

■ SUPERSHAPE BH4-15W E27/K

■ SUPERSHAPE BH4-20W E27/K

■ SUPERSHAPE BH5-24W E27/K

Kanlux	Kanlux	EAN	[W]	[lm]	[g]	DKC SK bez DPH
SUPERSHAPE BH4-15W E27/K	10504	5905339105042	15	800	70	5,68 €
SUPERSHAPE BH4-20W E27/K	10505	5905339105059	20	1100	90	5,68 €
SUPERSHAPE BH5-24W E27/K	10506	5905339105066	24	1450	110	5,68 €

220-240V~ 50/60Hz E27 Tc [K] 2700 Ra ≥80 A-EI 8000 1/10/60 CE

Kompaktná žiarivka

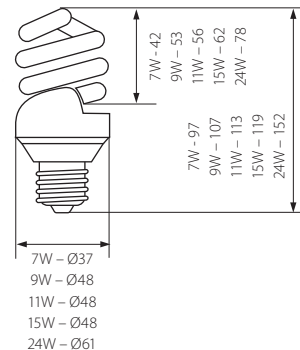

■ SPIRAL ETU-MSS 9W E27/K

■ SPIRAL ETU-MSS 15W E27/K

■ SPIRAL ETU-MSS 7W E14/K

■ SPIRAL ETU-MSS 11W E27/K

■ SPIRAL ETU-SS 24W E27/K

		EAN	[W]		[lm]	[h]		[g]	DKC SK bez DPH
SPIRAL ETU-MSS 7W E14/K	12600	5905339126009	7	E14	310	8000	1/20/100	35	5,21 €
SPIRAL ETU-MSS 9W E27/K	12605	5905339126054	9	E27	410	10000	1/10/50	56	5,21 €
SPIRAL ETU-MSS 11W E27/K	12606	5905339126061	11	E27	540	10000	1/10/50	59	5,21 €
SPIRAL ETU-MSS 15W E27/K	12607	5905339126078	15	E27	800	10000	1/10/50	63	5,21 €
SPIRAL ETU-SS 24W E27/K	12645	5905339126450	24	E27	1450	10000	1/10/50	93	5,21 €

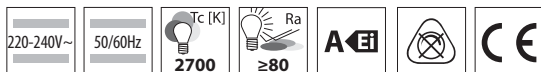

# SENSORSPIRAL ETU-CSS

Kompaktná žiarivka

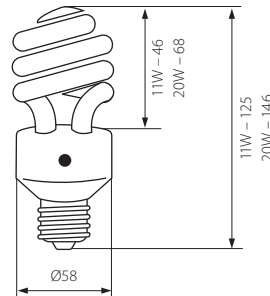

■ SENSORSPIRAL ETU-CSS 11W E27/K

■ SENSORSPIRAL ETU-CSS 20W E27/K

		EAN	[W]	[lm]	[g]	DKC SK bez DPH
SENSORSPIRAL ETU-CSS 11W E27/K	12640	5905339126405	11	540	75	6,64 €
SENSORSPIRAL ETU-CSS 20W E27/K	12641	5905339126412	20	1160	93	7,24 €

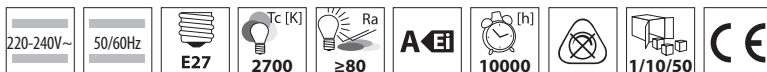

■ vstavané súmrakové čidlo umožňujúce samočinné zapnutie / vypnutie úspornej žiarivky v závislosti na úrovni okolného osvetlenia  
 ■ ochrana pred krátkym náhodným zvýšením intenzity okolného osvetlenia, ktoré by mohlo narušiť správnu funkciu úspornej žiarivky

Kompaktná žiarivka

2U XEU ... E14

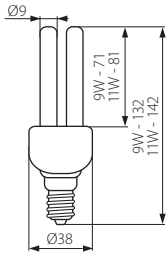

2U XEU ... E27

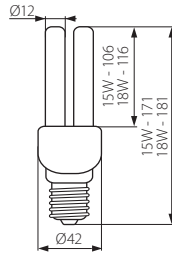

■ 2U XEU-9W E14



■ 2U XEU-15W E27



■ 2U XEU-11W E14



■ 2U XEU-18W E27

	<b>Kanlux</b>		EAN	[W]		[lm]	[g]	DKC SK bez DPH
<b>NEW</b>	2U XEU-9W E14	07630	5905339076304	9	E14	450	48	2,04 €
<b>NEW</b>	2U XEU-11W E14	07631	5905339076311	11	E14	550	50	2,04 €
<b>NEW</b>	2U XEU-15W E27	07632	5905339076328	15	E27	800	76	2,04 €
<b>NEW</b>	2U XEU-18W E27	07633	5905339076335	18	E27	1010	80	2,04 €



## 3U XEU

Kompaktná žiarivka

3U XEU ... E14

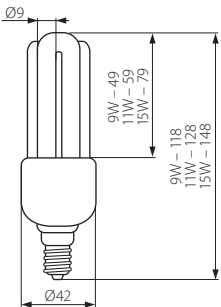

3U XEU ... E27

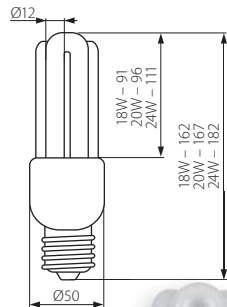

■ 3U XEU-9W E14



■ 3U XEU-15W E14



■ 3U XEU-18W E27



■ 3U XEU-20W E27



■ 3U XEU-24W E27



	<b>Kanlux</b>		EAN	[W]		[lm]	[g]	DKC SK bez DPH
<b>NEW</b>	3U XEU-9W E14	07640	5905339076403	9	E14	450	52	2,78 €
<b>NEW</b>	3U XEU-11W E14	07641	5905339076410	11	E14	550	54	2,78 €
<b>NEW</b>	3U XEU-15W E14	07642	5905339076427	15	E14	800	66	2,78 €
<b>NEW</b>	3U XEU-18W E27	07643	5905339076434	18	E27	1010	94	2,78 €
<b>NEW</b>	3U XEU-20W E27	07644	5905339076441	20	E27	1160	94	2,78 €
<b>NEW</b>	3U XEU-24W E27	07645	5905339076458	24	E27	1450	104	2,78 €



# 2U / 3U SLIM XEU23

**Kanlux**

Kompaktná žiarivka

■ 3U SLIM XEU23-15UC E14/K

■ 3U SLIM XEU23-9UC E14/K

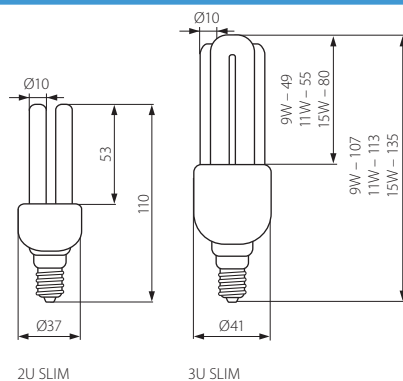

■ 2U SLIM XEU23-7W E14/K

■ 3U SLIM XEU23-11UC E14/K

<b>Kanlux</b>		EAN	[W]	[lm]	[g]	DKC SK bez DPH
2U SLIM XEU23-7W E14/K	10645	5905339106452	7	300	45	4,51 €
3U SLIM XEU23-9UC E14/K	10630	5905339106308	9	420	55	4,95 €
3U SLIM XEU23-11UC E14/K	10631	5905339106315	11	540	60	4,95 €
3U SLIM XEU23-15UC E14/K	10632	5905339106322	15	800	70	4,95 €

220-240V~	50/60Hz	E14	Tc [K] 2700	Ra ≥80	A E1	[h] 8000			
-----------	---------	-----	-------------	--------	------	----------	--	--	--

# SUPERSLIM ETU-M

Kompaktná žiarivka

■ SUPERSLIM ETU-M20W E27/K

■ SUPERSLIM ETU-M11W E27/K

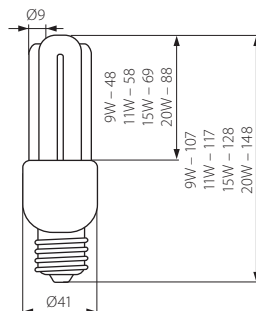

■ SUPERSLIM ETU-M9W E27/K

■ SUPERSLIM ETU-M15W E27/K

<b>Kanlux</b>		EAN	[W]	[lm]	[g]	DKC SK bez DPH
SUPERSLIM ETU-M9W E27/K	12615	5905339126153	9	410	53	5,21 €
SUPERSLIM ETU-M11W E27/K	12616	5905339126160	11	540	60	5,21 €
SUPERSLIM ETU-M15W E27/K	12617	5905339126177	15	800	66	5,21 €
SUPERSLIM ETU-M20W E27/K	12618	5905339126184	20	1160	69	5,21 €

220-240V~	50/60Hz	E27	Tc [K] 2700	Ra ≥80	A E1	[h] 10000			
-----------	---------	-----	-------------	--------	------	-----------	--	--	--



Kompaktná žiarivka

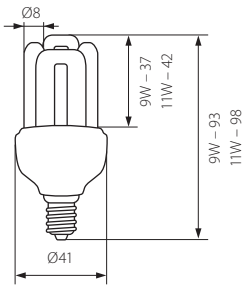

■ 4U MINI XEU48-9X E14/K



■ 4U MINI XEU48-11X E14/K

Kanlux		Kanlux	EAN	[W]	[lm]	[g]	DKC SK bez DPH
4U MINI XEU48-9X E14/K	12697	5905339126979	9	410	50	2,95 €	
4U MINI XEU48-11X E14/K	12698	5905339126986	11	545	55	2,95 €	

220-240V~	50/60Hz	E14	Tc [K] 2700	Ra ≥80	A	[h] 8000	1/10/100	CE
-----------	---------	-----	-------------	--------	---	----------	----------	----

## 4U XEU48

Kompaktná žiarivka

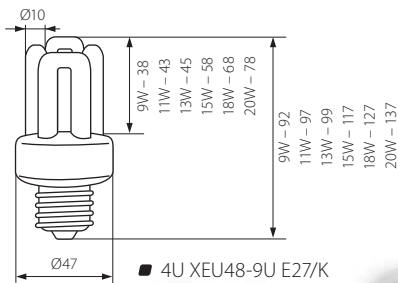

■ 4U XEU48-9U E27/K



■ 4U XEU48-11U E27/K



■ 4U XEU48-13U E27/K



■ 4U XEU48-15U E27/K



■ 4U XEU48-18U E27/K



■ 4U XEU48-20U E27/K



Kanlux		Kanlux	EAN	[W]	[lm]	[g]	DKC SK bez DPH
4U XEU48-9U E27/K	10680	5905339106803	9	430	65	5,18 €	
4U XEU48-11U E27/K	10681	5905339106810	11	550	70	5,18 €	
4U XEU48-13U E27/K	10682	5905339106827	13	670	75	5,18 €	
4U XEU48-15U E27/K	10683	5905339106834	15	810	80	5,18 €	
4U XEU48-18U E27/K	10684	5905339106841	18	1020	90	5,18 €	
4U XEU48-20U E27/K	10685	5905339106858	20	1160	100	5,18 €	

220-240V~	50/60Hz	E27	Tc [K] 2700	Ra ≥80	A	[h] 8000	1/10/100	CE
-----------	---------	-----	-------------	--------	---	----------	----------	----

Kompaktná žiarivka

■ FON CDL-7W E14

■ FON CDL-9W E14



■ FON CDL-7W E27

■ FON CDL-9W E27

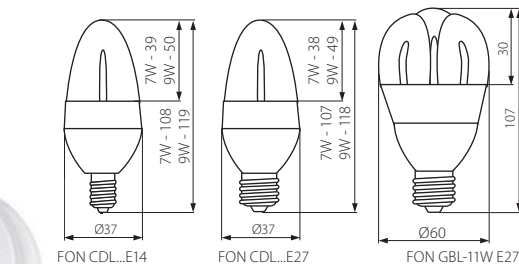

■ FON GBL-11W E27

Kanlux	Kanlux	EAN	[W]		[lm]		[g]	DKC SK bez DPH
FON CDL-7W E14	12840	5905339128409	7	E14	300	1/10/100	55	5,60 €
FON CDL-7W E27	12842	5905339128423	7	E27	300	1/10/100	57	5,60 €
FON CDL-9W E14	12841	5905339128416	9	E14	420	1/10/100	60	5,81 €
FON CDL-9W E27	12843	5905339128430	9	E27	420	1/10/100	62	5,81 €
FON GBL-11W E27	12850	5905339128508	11	E27	550	1/10/60	82	8,61 €

220-240V~ 50/60Hz Tc [K] 2700 Ra ≥80 A-Ei 8000

DART CDL

Kompaktná žiarivka



■ DART CDL-7 E14/K



■ DART CDL-11S E27/K

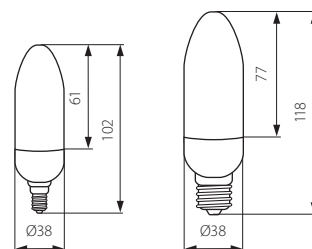

DART CDL-7 E14/K

DART CDL-11S E27/K

Kanlux	Kanlux	EAN	[W]		[lm]	[g]	DKC SK bez DPH
DART CDL-7 E14/K	10641	5905339106414	7	E14	286	45	4,08 €
DART CDL-11S E27/K	10640	5905339106407	11	E27	532	50	4,68 €

220-240V~ 50/60Hz Tc [K] 3500 Ra ≥80 A-Ei 8000 1/10/100



Kompaktná žiarivka

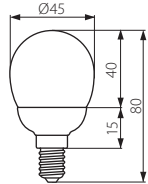

DAO GBL-7W E14

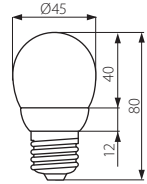

DAO GBL-7W E27



■ DAO GBL-7W E14



■ DAO GBL-7W E27

<b>Kanlux</b>	<b>Kanlux</b>	EAN 				DKC SK bez DPH
<b>NEW</b> DAO GBL-7W E14	07791	5905339077912	E14	teplá biela	35	4,41 €
<b>NEW</b> DAO GBL-7W E27	07790	5905339077905	E27	teplá biela	40	4,41 €

Kompaktná žiarivka

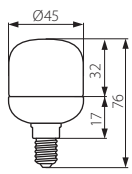

DAO QDL-7W E14

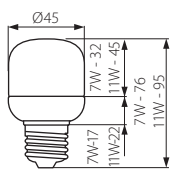

DAO QDL...E27



■ DAO QDL-7W E14



■ DAO QDL-7W E27



■ DAO QDL-11W E27

<b>Kanlux</b>	<b>Kanlux</b>	EAN 						DKC SK bez DPH
<b>NEW</b> DAO QDL-7W E14	07771	5905339077714	7	E14	290	teplá biela	45	4,41 €
<b>NEW</b> DAO QDL-7W E27	07770	5905339077707	7	E27	290	teplá biela	40	4,41 €
<b>NEW</b> DAO QDL-11W E27	07780	5905339077806	11	E27	550	teplá biela	55	4,63 €

# MINIGLOB XEU48

Kompaktná žiarivka

**Kanlux**

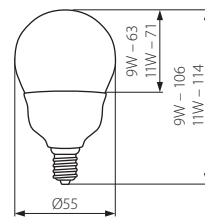

■ MINIGLOB XEU48-9XG E14/K

■ MINIGLOB XEU48-11XG E14/K

<b>Kanlux</b>	<b>Kanlux</b>	EAN	[W]	[lm]	[g]	DKC SK bez DPH
MINIGLOB XEU48-9XG E14/K	12695	5905339126955	9	405	50	3,65 €
MINIGLOB XEU48-11XG E14/K	12696	5905339126962	11	532	55	4,12 €

220-240V~	50/60Hz	E14	Tc [K] 3500	Ra ≥80	A E1	8000 [h]	1/10/100	CE
-----------	---------	-----	-------------	--------	------	----------	----------	----

# GLOB XEU48

Kompaktná žiarivka

■ GLOB XEU48-15G E27/K

■ GLOB XEU48-9XG E27/K

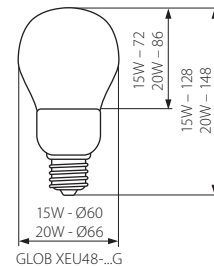
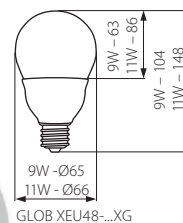

■ GLOB XEU48-11XG E27/K

■ GLOB XEU48-20G E27/K

<b>Kanlux</b>	<b>Kanlux</b>	EAN	[W]	[lm]	[g]	DKC SK bez DPH
GLOB XEU48-9XG E27/K	12690	5905339126900	9	405	55	4,12 €
GLOB XEU48-11XG E27/K	12691	5905339126917	11	532	55	4,12 €
GLOB XEU48-15G E27/K	10615	5905339106155	15	800	90	6,84 €
GLOB XEU48-20G E27/K	10616	5905339106162	20	1158	115	6,84 €

  

220-240V~	50/60Hz	E27	Tc [K] 3500	Ra ≥80	A E1	8000 [h]	CE
-----------	---------	-----	-------------	--------	------	----------	----

Kompaktná žiarivka

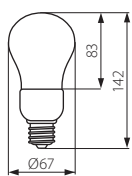

SUPERGLOB XEU23-15G1

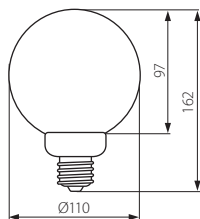

SUPERGLOB XEU38-20G



■ SUPERGLOB XEU23-15G1 E27/K



■ SUPERGLOB XEU38-20G E27/K

Kanlux	Kanlux	EAN	[W]	Tc [K]	[lm]	[g]	DKC SK bez DPH
SUPERGLOB XEU23-15G1 E27/K	10612	5905339106124	15	3200	800	90	5,97 €
SUPERGLOB XEU38-20G E27/K	10620	5905339106209	20	3500	1152	150	6,41 €



## BALTA -24W 118MM

Kompaktná žiarivka nástrčná

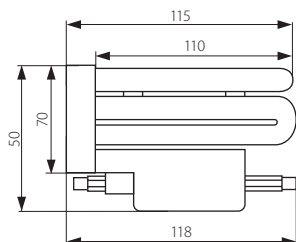

■ BALTA-24W 118MM

■ JEN CE-82-B BALTA - strana 162



Kanlux	Kanlux	EAN		DKC SK bez DPH
<b>NEW</b> BALTA-24W 118MM	07450	5905339074508	biela	8,57 €

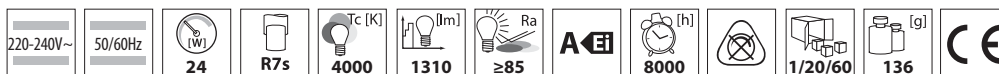

- nahrádza halogenovú žiarovku J 118
- použitie žiariviek v uzatvorených svetidlách môže mať za následok skrátenie životnosti žiarivky v porovnaní s takou istou pracujúcou za optimálnej teploty okolia 25 °C /alebo v otvorenom priestore
- v prípade použitia svetidiel v okruhoch s čidlom pohybu môže dôjsť k skráteniu životnosti vzhľadom k častému zapínaniu

Úsporná kompaktná žiarivka s reflektorom

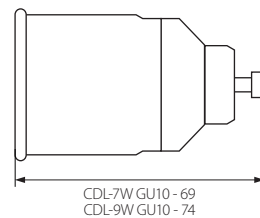
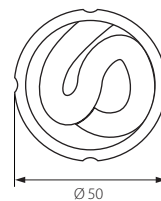

■ CDL-7W GU10



■ CDL-9W GU10

<b>Kanlux</b>	<b>Kanlux</b>	EAN	[W]	[cd]	[g]	DKC SK bez DPH
CDL-7W GU10	12731	5905339127310	7	50	52	12,91 €
CDL-9W GU10	12732	5905339127327	9	70	58	13,64 €

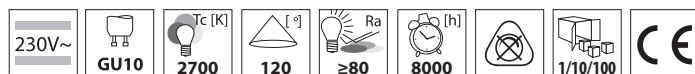

## ESG-75 9W GX53

Kompaktná žiarivka nástrčná

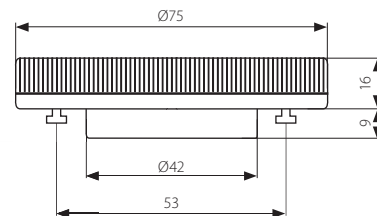

■ ESG-75 9W GX53

■ KREON TL a FAUST - strana 98



<b>Kanlux</b>	<b>Kanlux</b>	EAN		DKC SK bez DPH
<b>NEW</b> ESG-75 9W GX53	07430	5905339074300	teplá biela	8,32 €

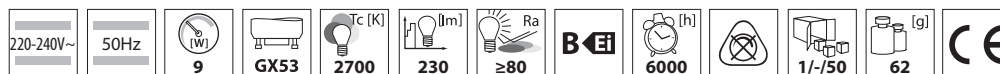



Kruhová žiarivka nástrčná

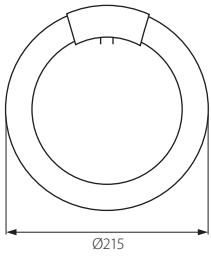

■ FCL-22W/4P 2700K

		EAN 	DKC SK bez DPH
FCL-22W/4P 2700K	12670	5905339126702	4,98 €
22	G10q	Tc [K] 2700	Ra ≥80
1100	B	[h] 8000	
1/-/20	[g] 235		

Kompaktná žiarivka nástrčná

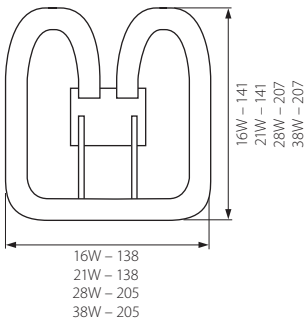

■ DD-28W/4P 3500K



■ DD-16W/2P 3500K

		EAN 	[W]		[lm]		[g]	DKC SK bez DPH
DD-16W/2P 3500K	12650	5905339126504	16	GR8	980	1/-/80	52	2,62 €
DD-16W/4P 3500K	12660	5905339126603	16	GR10q	980	1/-/80	52	2,69 €
DD-21W/4P 3500K	12661	5905339126610	21	GR10q	1280	1/-/80	52	2,76 €
DD-28W/4P 3500K	12662	5905339126627	28	GR10q	1750	1/-/60	124	4,18 €
DD-38W/4P 3500K	12663	5905339126634	38	GR10q	2600	1/-/60	124	4,35 €
Tc [K] 3500	Ra ≥80	B	[h] 8000					

# T1U

Kompaktná žiarivka nástrčná

**Kanlux**

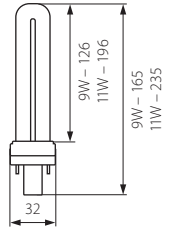

■ T1U-9W/K



■ T1U-11W/K

<b>Kanlux</b>		EAN		[W]	[lm]	[g]	DKC SK bez DPH
T1U-9W/K	10671	5905339106711		9	580	30	1,26 €
T1U-11W/K	10672	5905339106728		11	780	46	1,26 €



# T2U

Kompaktná žiarivka nástrčná

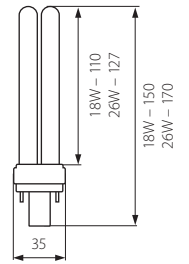

■ T2U-18W/K



■ T2U-26W/K

<b>Kanlux</b>		EAN		[W]	[lm]	[g]	DKC SK bez DPH
T2U-18W/K	10661	5905339106612		18	1100	46	1,66 €
T2U-26W/K	10662	5905339106629		26	1600	54	1,66 €







Lineárna žiarivka

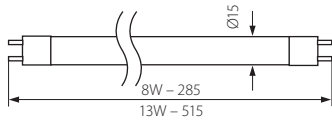

■ T5-8W 2700K/65

■ T5-8W 4000K/65

■ T5-13W 2700K/65

■ T5-13W 4000K/65



		EAN 	[W]	Tc [K]	[lm]	[g]	DKC SK bez DPH
T5-8W 2700K/65	12710	5905339127105	8	2700	350	30	0,90 €
T5-8W 4000K/65	12715	5905339127150	8	4000	350	30	0,90 €
T5-13W 2700K/65	12711	5905339127112	13	2700	750	46	1,39 €
T5-13W 4000K/65	12716	5905339127167	13	4000	750	46	1,39 €

■ trojpásmové žiarivky

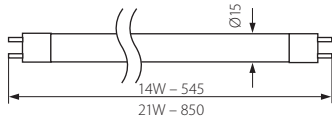

■ T5-14W 2700K/82

■ T5-14W 4000K/82

■ T5-21W 2700K/82

■ T5-21W 4000K/82



		EAN 	[W]	Tc [K]	[lm]	[g]	DKC SK bez DPH
T5-14W 2700K/82	12712	5905339127129	14	2700	1140	64	2,29 €
T5-14W 4000K/82	12717	5905339127174	14	4000	1140	64	2,29 €
T5-21W 2700K/82	12713	5905339127136	21	2700	1850	100	2,76 €
T5-21W 4000K/82	12718	5905339127181	21	4000	1850	100	2,76 €

■ trojpásmové žiarivky



Lineárna žiarivka

Lineárna žiarivka

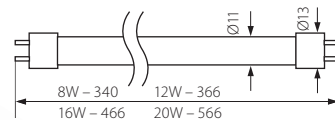

■ T4-8W 4000K



■ T4-12W 4000K

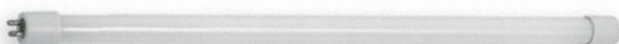

■ T4-16W 4000K



■ T4-20W 4000K



		EAN 	[W]	[lm]		[g]	DKC SK bez DPH
T4-8W 4000K	10930	5905339109309	8	645	A	32	1,96 €
T4-12W 4000K	10931	5905339109316	12	725	B	36	1,96 €
T4-16W 4000K	10932	5905339109323	16	1020	B	42	2,46 €
T4-20W 4000K	10933	5905339109330	20	1200	B	50	2,99 €

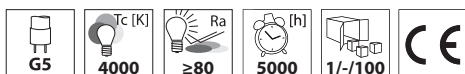

■ trojpásmové žiarivky

Reflektorová žiarivka



■ R39 30W E14/K



■ R50 25W E14/K



■ R63 40W E27/K

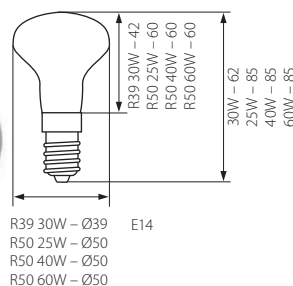

		EAN 	[W]		[cd]	[°]		[g]	DKC SK bez DPH
R39 30W E14/K	12550	5905339125507	30	E14	75	80	1/10/200	10	0,56 €
R50 25W E14/K	12551	5905339125514	25	E14	160	35	1/10/100	14	0,56 €
R50 40W E14/K	12552	5905339125521	40	E14	320	35	1/10/100	14	0,56 €
R50 60W E14/K	12553	5905339125538	60	E14	580	35	1/10/100	14	0,56 €
R63 40W E27/K	12554	5905339125545	40	E27	380	35	1/10/100	28	0,66 €
R63 60W E27/K	12555	5905339125552	60	E27	650	35	1/10/100	28	0,66 €



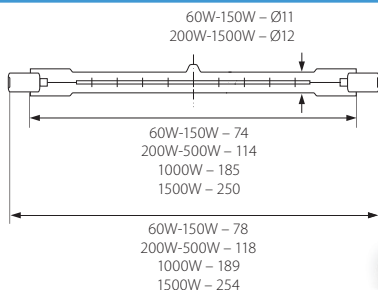

Halogénová žiarovka lineárna

■ J-100W 78MM/EK **basic**



■ J-100W 118MM **premium**

Kanlux	Kanlux	EAN	[W]	[lm]	Ei	[h]	[g]	DKC SK bez DPH
J-100W 78MM/EK BASIC	10700	5905339107008	100	1050	F	1200	1/50/500	8,83 €
J-150W 78MM/EK BASIC	10701	5905339107015	150	1700	F	1200	1/50/500	8,83 €
J-200W 118MM/EK BASIC	10712	5905339107121	200	2300	F	1200	1/50/500	8,83 €
J-300W 118MM/EK BASIC	10714	5905339107145	300	3800	F	1200	1/50/500	8,83 €
J-500W 118MM/EK BASIC	10716	5905339107169	500	7600		1200	1/50/500	8,83 €
J-60W 78MM PREMIUM	10404	5905339104045	60	550	F	2000	1/50/500	1,06 €
J-100W 78MM PREMIUM	10400	5905339104007	100	1100	F	2000	1/50/500	1,06 €
J-150W 78MM PREMIUM	10401	5905339104014	150	1800	F	2000	1/50/500	1,06 €
J-100W 118MM PREMIUM	10410	5905339104106	100	1050	F	2000	1/50/500	1,06 €
J-150W 118MM PREMIUM	10411	5905339104113	150	1800	F	2000	1/50/500	1,06 €
J-200W 118MM PREMIUM	10412	5905339104120	200	2400	F	2000	1/50/500	1,06 €
J-300W 118MM PREMIUM	10414	5905339104144	300	4000	F	2000	1/50/500	1,06 €
J-500W 118MM PREMIUM	10416	5905339104168	500	8000		2000	1/50/500	1,06 €
J-1000W 189MM PREMIUM	10418	5905339104182	1000	16000		2000	1/25/250	1,99 €
J-1500W 254MM PREMIUM	10419	5905339104199	1500	31000		2000	1/25/250	1,99 €

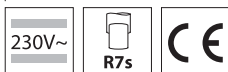

■ pracovná poloha horizontálna, prípustná odchýlka +/- 4°

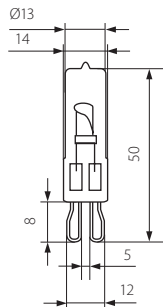

Halogénová žiarovka

■ G9-25W/EK **basic**



■ G9-60W



Kanlux	Kanlux	EAN	[W]	[lm]	[g]	DKC SK bez DPH
G9-25W/EK BASIC	12700	5905339127006	25	210	3	1,16 €
G9-40W/EK BASIC	12701	5905339127013	40	410	3	1,16 €
G9-60W/EK BASIC	12702	5905339127020	60	700	3	1,16 €
G9-25W	10870	5905339108708	25	225	4	1,46 €
G9-40W	10871	5905339108715	40	425	4	1,46 €
G9-60W	10872	5905339108722	60	750	4	1,46 €



Halogénová žiarovka s ochranným sklom



■ JDR+A50W60C/EK  
**basic**



■ JDR+A20W60C  
**premium**

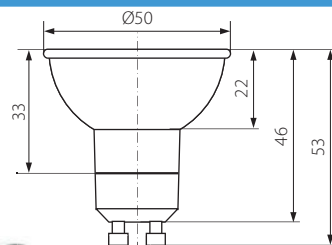

		EAN 	[W]	[cd]	[°]	[h]	[g]	DKC SK bez DPH
JDR+A20W60C/EK BASIC	10814	5905339108142	20	200	60	1100	42	1,89 €
JDR+A35W60C/EK BASIC	10815	5905339108159	35	320	60	1100	42	1,89 €
JDR+A50W60C/EK BASIC	10816	5905339108166	50	510	60	1100	42	1,89 €
JDR+A20W36C PREMIUM	10761	5905339107619	20	360	36	1500	44	2,52 €
JDR+A20W60C PREMIUM	10767	5905339107671	20	250	60	1500	44	2,52 €
JDR+A35W36C PREMIUM	10763	5905339107633	35	580	36	1500	44	2,52 €
JDR+A35W60C PREMIUM	10769	5905339107695	35	380	60	1500	44	2,52 €
JDR+A50W36C PREMIUM	10765	5905339107657	50	800	36	1500	44	2,52 €
JDR+A50W60C PREMIUM	10771	5905339107718	50	550	60	1500	44	2,52 €

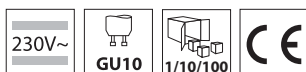

# JC

Halogénová žiarovka



■ JC-10W4/EK  
**basic**



■ JC-20W G4  
**premium**

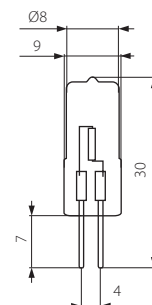

		EAN 	[W]	[lm]	[h]	[g]	DKC SK bez DPH
JC-10W4/EK BASIC	10432	5905339104328	10	90	1500	1/100/1000	0,56 €
JC-20W4/EK BASIC	10433	5905339104335	20	280	1500	1/100/1000	0,56 €
JC-35W4/EK BASIC	10434	5905339104342	35	500	1500	1/100/1000	0,56 €
JC-5W G4 PREMIUM	10720	5905339107206	5	60	2000	1/50/1000	0,73 €
JC-10W G4 PREMIUM	10722	5905339107220	10	120	2000	1/50/1000	0,73 €
JC-20W G4 PREMIUM	10724	5905339107244	20	330	2000	1/50/1000	0,73 €
JC-35W G4 PREMIUM	10726	5905339107268	35	600	2000	1/50/1000	0,73 €

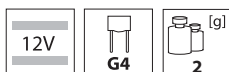

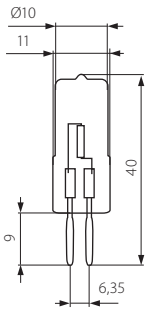

■ JC-20W GY6.35  
**premium**

Kanlux	Kanlux	EAN	[W]	[lm]	DKC SK bez DPH
JC-20W GY6.35 PREMIUM	10730	5905339107305	20	330	0,73 €
JC-35W GY6.35 PREMIUM	10732	5905339107329	35	600	0,73 €
JC-50W GY6.35 PREMIUM	10734	5905339107343	50	950	0,73 €

12V	GY6.35	2000 [h]	1/50/1000	2 [g]
-----	--------	----------	-----------	-------

# MR-11C

Halogénová žiarovka s ochranným sklom

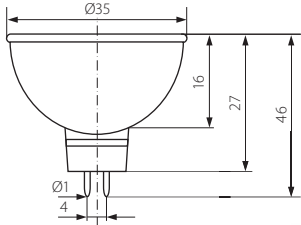

■ MR-11C 20W30/EK  
**basic**



■ MR-11C 20W30  
**premium**

Kanlux	Kanlux	EAN	[W]	[cd]	[h]	DKC SK bez DPH	
MR-11C 20W30/EK BASIC	12517	5905339125170	20	480	1500	1/10/200	0,60 €
MR-11C 35W30/EK BASIC	12518	5905339125187	35	720	1500	1/10/200	0,60 €
MR-11C 20W30 PREMIUM	10363	5905339103635	20	550	2000	1/20/200	0,86 €
MR-11C 35W30 PREMIUM	10364	5905339103642	35	850	2000	1/20/200	0,86 €

12V	GU4	30 [°]	14 [g]
-----	-----	--------	--------

■ halogénové žiarovky MR-11C rady premium sú vybavené upraveným reflektorom pomocou ktorého došlo k zvýšeniu svetelného toku a zníženiu emisie tepla v smere osvetľovaného predmetu

# MR-16C

**Kanlux**

Halogénová žiarovka s ochranným sklom

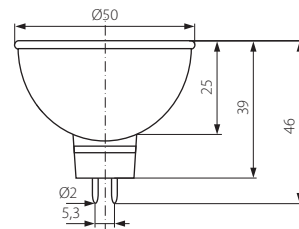

■ MR-16C 20W36/EK **basic**

■ MR-16C 20W36 **premium**

<b>Kanlux</b>		EAN		[W]	[cd]		[°]		[h]	DKC SK bez DPH
MR-16C 20W36/EK BASIC	12502	5905339125026		20	450		36		1500	0,60 €
MR-16C 20W60/EK BASIC	12503	5905339125033		20	250		60		1500	0,60 €
MR-16C 35W36/EK BASIC	12506	5905339125064		35	850		36		1500	0,60 €
MR-16C 35W60/EK BASIC	12507	5905339125071		35	600		60		1500	0,60 €
MR-16C 50W40/EK BASIC	12511	5905339125118		50	1800		40		1500	0,60 €
MR-16C 50W60/EK BASIC	12512	5905339125125		50	700		60		1500	0,60 €
MR-16C 20W36 PREMIUM	10302	5905339103024		20	500		36		2000	0,86 €
MR-16C 20W60 PREMIUM	10303	5905339103031		20	300		60		2000	0,86 €
MR-16C 35W36 PREMIUM	10306	5905339103062		35	880		36		2000	0,86 €
MR-16C 35W60 PREMIUM	10307	5905339103079		35	640		60		2000	0,86 €
MR-16C 50W40 PREMIUM	10311	5905339103116		50	1870		40		2000	0,86 €
MR-16C 50W60 PREMIUM	10312	5905339103123		50	790		60		2000	0,86 €

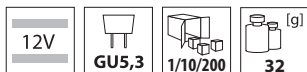

■ halogénové žiarovky MR-16C rady premium sú vybavené upraveným reflektorom pomocou ktorého došlo k zvýšeniu svetelného toku a zníženiu emisie tepla v smere osvetľovaného predmetu

# AR-111

Halogénová žiarovka s reflektorom

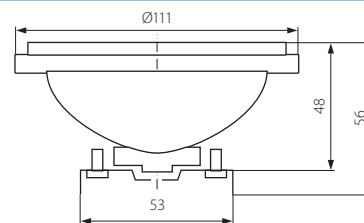

■ AR-111 35W45

■ reflektor: hliník

<b>Kanlux</b>		EAN		[W]	[cd]	DKC SK bez DPH
AR-111 35W45	10852	5905339108524		35	600	5,58 €
AR-111 50W45	10857	5905339108579		50	900	5,58 €

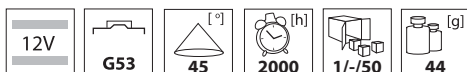



Metalhalogenidová výbojka

MHR-70W/3000K

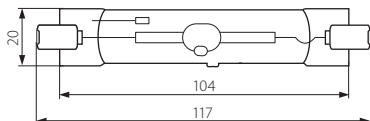

MHR-150W/3000K

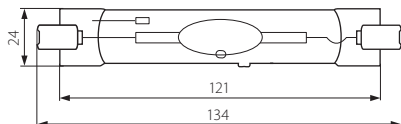

■ MHR-70W/3000K



■ MHR-150W/3000K

Kanlux	Kanlux	EAN	[W]	[lm]	[g]	DKC SK bez DPH
MHR-70W/3000K	12750	5905339127501	70	5600	20	15,07 €
MHR-150W/3000K	12751	5905339127518	150	12500	26	15,07 €



- metalhalogenidové výbojky pracujú so stabilizátormi do vysokotlakových sodíkových výbojok
- prúd výbojky 70W - 0,98A, 150W - 1,8A
- horizontálna pracovná poloha, prípustná odchylka  $\pm 45^\circ$

Metalhalogenidová výbojka

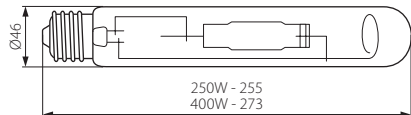

■ MHE-250W/4200K



■ MHE-400W/4200K

Kanlux	Kanlux	EAN	[W]	[lm]	[g]	DKC SK bez DPH
MHE-250W/4200K	12755	5905339127556	250	20000	156	19,39 €
MHE-400W/4200K	12756	5905339127563	400	35000	178	21,54 €



- metalhalogenidové výbojky pracujú so stabilizátormi do vysokotlakových sodíkových výbojok
- prúd výbojky 250W - 2,1A, 400W - 3,3A
- horizontálna pracovná poloha, prípustná odchylka  $\pm 45^\circ$



Vstavané svietidlá

## ULKE CT-2113

Podhľadové bodové svietidlo



53



196-197

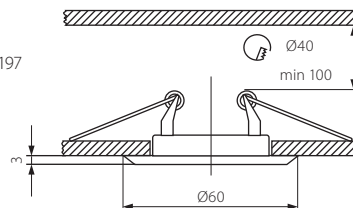

■ ULKE CT-2113-C/M



■ ULKE CT-2113-C

■ teleso svietidla: kovový výlisok

		EAN 		DKC SK bez DPH
ULKE CT-2113-C ULKE CT-2113-C/M	00321 00355	5905339003218 5905339003553	chróm matný chróm	1,69 € 1,69 €





Podhľadové bodové svetidlo

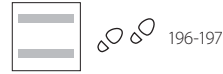
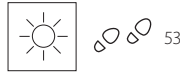
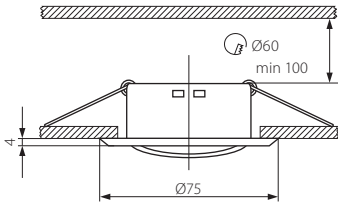

■ ULKE CT-2119-C



■ ULKE CT-2119-C/M



■ ULKE CT-2119-BR/M

■ teleso svetidla: kovový výlisok

<b>Kanlux</b>		EAN 		DKC SK bez DPH
ULKE CT-2119-BR/M	00348	5905339003485	matná mosadz	2,12 €
ULKE CT-2119-C	00313	5905339003133	chróm	2,12 €
ULKE CT-2119-C/M	00349	5905339003492	matný chróm	2,12 €

12V									IP 20						CE
-----	--	--	--	--	--	--	--	--	-------	--	--	--	--	--	----



Podhľadové bodové svetidlo

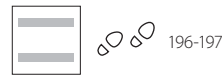
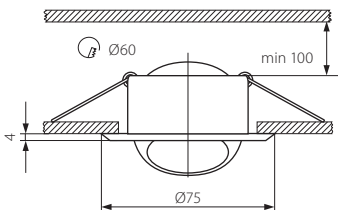

■ ULKE CT-2118-C



■ ULKE CT-2118-C/M

■ teleso svetidla: kovový výlisok

<b>Kanlux</b>		EAN 		DKC SK bez DPH
ULKE CT-2118-C	00315	5905339003157	chróm	2,99 €
ULKE CT-2118-C/M	00343	5905339003430	matný chróm	2,99 €

12V									IP 20						CE
-----	--	--	--	--	--	--	--	--	-------	--	--	--	--	--	----

# ARGUS CT-2114

**Kanlux**

Podhľadové bodové svetidlo



31-33,  
54



196-197

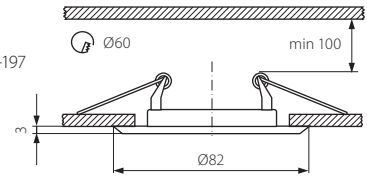

■ ARGUS CT-2114-C/M



■ ARGUS CT-2114-G



■ ARGUS CT-2114-W



■ ARGUS CT-2114-AN



■ ARGUS CT-2114-BR/M



■ ARGUS CT-2114-C



■ ARGUS CT-2114-GM



■ teleso svetidla: kovový výlisok

Kanlux	Kanlux	EAN		DKC SK bez DPH
ARGUS CT-2114-W	00303	5905339003034	biela	1,96 €
ARGUS CT-2114-G	00300	5905339003003	zlatá	1,96 €
ARGUS CT-2114-BR/M	00324	5905339003249	matná mosadz	1,96 €
ARGUS CT-2114-AN	00327	5905339003270	antik	1,96 €
ARGUS CT-2114-C	00301	5905339003010	chróm	1,96 €
ARGUS CT-2114-C/M	00325	5905339003256	matný chróm	1,96 €
ARGUS CT-2114-GM	00328	5905339003287	čierny chróm	1,96 €

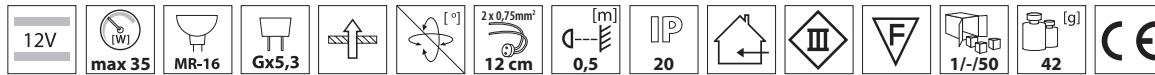

# ARGUS CT-2115

Podhľadové bodové svetidlo



31-33,  
54



196-197

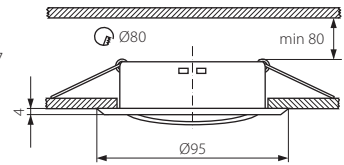

■ ARGUS CT-2115-C/M



■ ARGUS CT-2115-YG



■ ARGUS CT-2115-AN



■ ARGUS CT-2115-C



■ ARGUS CT-2115-W



■ ARGUS CT-2115-GM



■ ARGUS CT-2115-G



■ ARGUS CT-2115-BR/M



■ teleso svetidla: kovový výlisok

Kanlux	Kanlux	EAN		DKC SK bez DPH
ARGUS CT-2115-W	00307	5905339003072	biela	2,99 €
ARGUS CT-2115-G	00304	5905339003041	zlatá	2,99 €
ARGUS CT-2115-YG	00335	5905339003355	žlté zlato	2,99 €
ARGUS CT-2115-BR/M	00330	5905339003300	matná mosadz	2,99 €
ARGUS CT-2115-AN	00333	5905339003331	antik	2,99 €
ARGUS CT-2115-C	00305	5905339003058	chróm	2,99 €
ARGUS CT-2115-C/M	00331	5905339003317	matný chróm	2,99 €
ARGUS CT-2115-GM	00334	5905339003348	čierny chróm	2,99 €

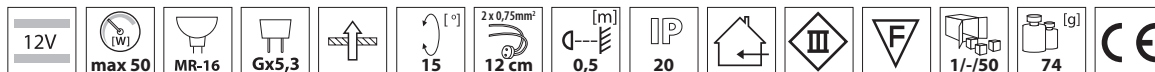



Podhľadové bodové svetidlo

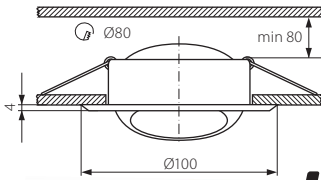

■ ARGUS CT-2117-G



31-33, 54



196-197



■ ARGUS CT-2117-BR/M



■ ARGUS CT-2117-W



■ ARGUS CT-2117-C/M



■ ARGUS CT-2117-C



■ ARGUS CT-2117-AN



■ ARGUS CT-2117-GM

■ teleso svetidla: kovový výlisok

Kanlux	Kanlux	EAN		DKC SK bez DPH
ARGUS CT-2117-W	00311	5905339003119	biela	4,02 €
ARGUS CT-2117-G	00308	5905339003089	zlatá	4,22 €
ARGUS CT-2117-BR/M	00336	5905339003362	matná mosadz	4,48 €
ARGUS CT-2117-AN	00339	5905339003393	antik	4,48 €
ARGUS CT-2117-C	00309	5905339003096	chróm	4,22 €
ARGUS CT-2117-C/M	00337	5905339003379	matný chróm	4,48 €
ARGUS CT-2117-GM	00340	5905339003409	čierny chróm	2,99 €

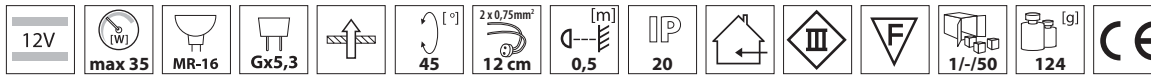

Podhľadové bodové svetidlo

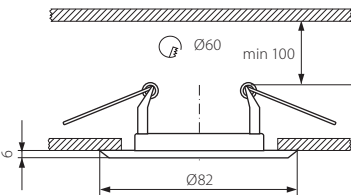

■ HORN CTC-3114-GM/N



31-33, 54



196-197



■ HORN CTC-3114-PS/G



■ HORN CTC-3114-PG/N



■ HORN CTC-3114-SN/N



■ HORN CTC-3114-SN/G

■ teleso svetidla: kovový výlisok

Kanlux	Kanlux	EAN		DKC SK bez DPH
HORN CTC-3114-SN/G	02820	5905339028204	saténový nikel/zlatá	2,12 €
HORN CTC-3114-SN/N	02821	5905339028211	saténový nikel/nikel	2,12 €
HORN CTC-3114-PS/G	02822	5905339028228	perleťovo strieborná/zlatá	2,42 €
HORN CTC-3114-PG/N	02823	5905339028235	perleťovo zlatá/nikel	2,42 €
HORN CTC-3114-GM/N	02824	5905339028242	čierny chróm/nikel	2,42 €

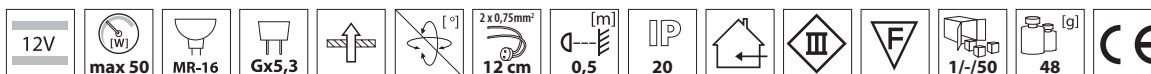

# HORN CTC-3115

**Kanlux**

Podhľadové bodové svetidlo



■ HORN CTC-3115-SN/G



■ HORN CTC-3115-PG/N



■ HORN CTC-3115-SN/N



■ HORN CTC-3115-GM/N

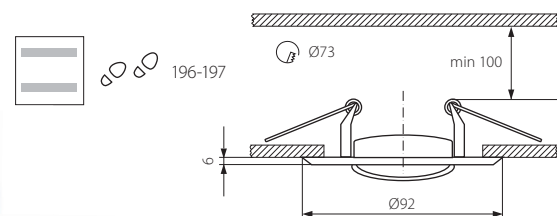

■ HORN CTC-3115-PS/G

■ teleso svetidla: kovový výlisok

Kanlux	Kanlux	EAN
HORN CTC-3115-PG/N	02833	5905339028334
HORN CTC-3115-PS/G	02832	5905339028327
HORN CTC-3115-SN/G	02830	5905339028303
HORN CTC-3115-SN/N	02831	5905339028310
HORN CTC-3115-GM/N	02834	5905339028341

■ HORN CTC-3115-GM/N	DKC SK bez DPH
perleťovo zlatá/nikel	2,99 €
perleťovo strieborná/zlatá	2,99 €
saténový nikel/zlatá	2,99 €
saténový nikel/nikel	2,99 €
čierny chróm/nikel	2,99 €

12V max 50 MR-16 Gx5,3 15 2x 0,75mm<sup>2</sup> 12 cm 0,5 IP 20 III F 1/-/50 66 [g] CE

# CEL CTC-5519-C/M

Podhľadové bodové svetidlo



■ CEL CTC-5519-C/M

■ teleso svetidla: odliatok z hliníkovej zliatiny

Kanlux	Kanlux	EAN
CEL CTC-5519-C/M	02755	5905339027559

■ CEL CTC-5519-C/M	DKC SK bez DPH
matný chróm	3,55 €

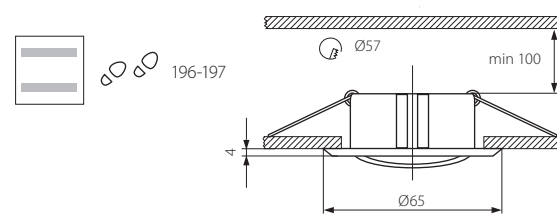

12V max 35 MR-11 Gx4 15 2x 0,75mm<sup>2</sup> 12 cm 0,5 IP 20 III F 1/-/100 86 [g] CE



Podhľadové bodové svetidlo

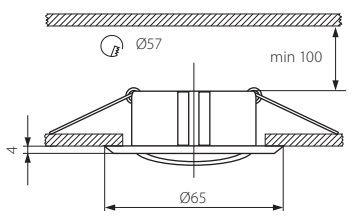

53



196-197



■ PARLE CTC-5519-MPC/N



■ PARLE CTC-5519-PS/G



■ PARLE CTC-5519-PG/N



■ PARLE CTC-5519-SN/G



■ PARLE CTC-5519-SN/N

■ teleso svetidla: odliatok z hliníkovej zliatiny

Kanlux	Kanlux	EAN
PARLE CTC-5519-MPC/N	02753	5905339027535
PARLE CTC-5519-PG/N	02754	5905339027542
PARLE CTC-5519-PS/G	02751	5905339027511
PARLE CTC-5519-SN/G	02750	5905339027504
PARLE CTC-5519-SN/N	02752	5905339027528



matne perleťový chróm/nikel  
perleťovo zlatá/nikel  
perleťovo strieborná/zlatá  
saténový nikel/zlatá  
saténový nikel/nikel

DKC SK bez DPH
3,85 €
3,85 €
3,85 €
3,85 €
3,85 €

12V max 35 MR-11 Gx4 15 2 x 0,75mm<sup>2</sup> 12 cm 0,5 IP 20 1/-/100 86 CE



Podhľadové bodové svetidlo

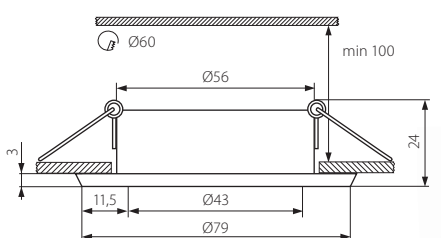

RADAN CT-DSO50

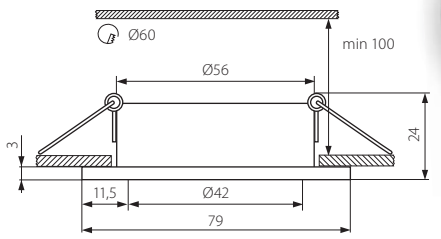

RADAN CT-DLS50



31-33, 54



196-197



■ RADAN CT-DSO50



■ RADAN CT-DLS50

■ teleso svetidla: odliatok z hliníkovej zliatiny

NEW	Kanlux	Kanlux	EAN
NEW	RADAN CT-DSO50	07362	5905339073624
NEW	RADAN CT-DLS50	07363	5905339073631



hliník  
hliník



50  
60

DKC SK bez DPH
4,7 €
4,7 €

12V max 50 MR-16 Gx5,3 15 2 x 0,75mm<sup>2</sup> 12 cm 0,5 IP 20 max 35 max 50 1/-/50 CE

# RADAN CT-DT

**Kanlux**

Podhľadové bodové svetidlo



31-33, 54



196-197



■ RADAN CT-DT050



■ RADAN CT-DT150

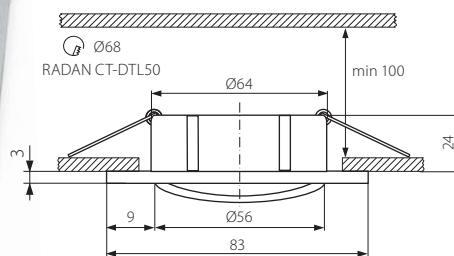
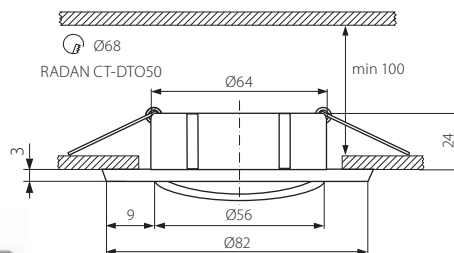

■ teleso svetidla: odliatok z hliníkovej zliatiny

**Kanlux**

**Kanlux**

EAN



DKC SK bez DPH

NEW	RADAN CT-DT050	07360	5905339073600	hliník	70	6,2 €
NEW	RADAN CT-DT150	07361	5905339073617	hliník	80	6,2 €



# LUTO CTX-DS02B

Podhľadové bodové svetidlo



31-33, 54



196-197

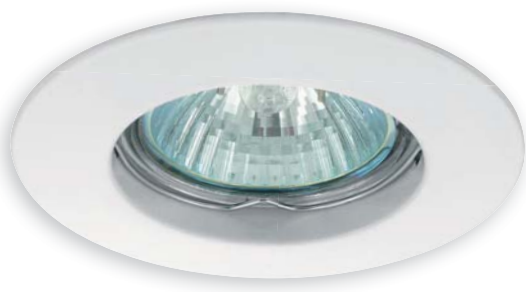

■ LUTO CTX-DS02B-W



■ LUTO CTX-DS02B-AB



■ LUTO CTX-DS02B-C/M

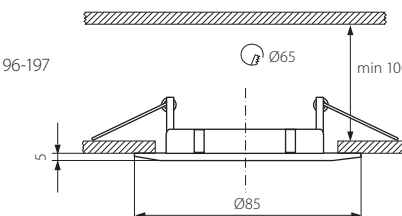

■ teleso svetidla: odliatok z hliníkovej zliatiny

**Kanlux**

**Kanlux**

EAN



DKC SK bez DPH

LUTO CTX-DS02B-W	02580	5905339025807	biela	3,55 €
LUTO CTX-DS02B-AB	02584	5905339025845	mosadz s patinou	4,55 €
LUTO CTX-DS02B-C	02581	5905339025814	chróm	4,55 €
LUTO CTX-DS02B-C/M	02583	5905339025838	matný chróm	4,55 €

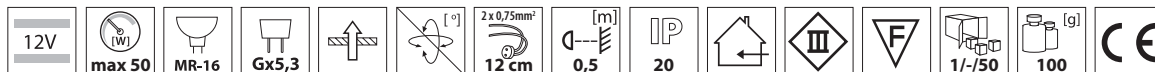

■ široký krúžok



Podhľadové bodové svetidlo

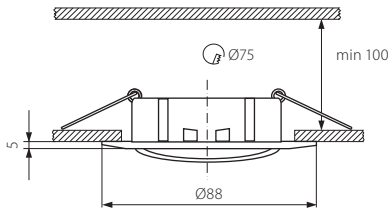

31-33, 54



196-197

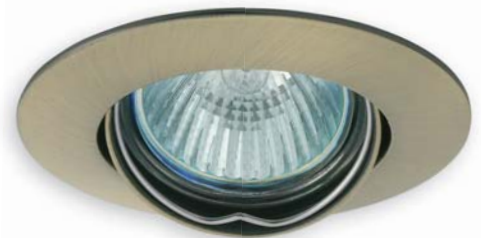

■ LUTO CTX-DT02B-AB



■ LUTO CTX-DT02B-W



■ LUTO CTX-DT02B-C/M



■ LUTO CTX-DT02B-C

■ teleso svetidla: odliatok z hliníkovej zliatiny

Kanlux	Kanlux	EAN		DKC SK bez DPH
LUTO CTX-DT02B-W	02590	5905339025906	biela	4,55 €
LUTO CTX-DT02B-AB	02594	5905339025944	mosadz s patinou	2,56 €
LUTO CTX-DT02B-C	02591	5905339025913	chróm	5,58 €
LUTO CTX-DT02B-C/M	02593	5905339025937	matný chróm	5,58 €

■ široký krúžok



Podhľadové bodové svetidlo

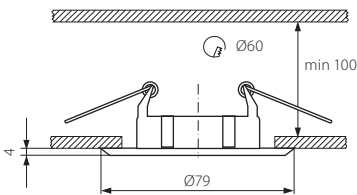

31-33, 54



196-197



■ VIDI CTC-5514-W



■ VIDI CTC-5514-C/M

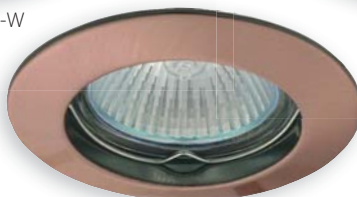

■ VIDI CTC-5514-AN



■ VIDI CTC-5514-C

■ teleso svetidla: odliatok z hliníkovej zliatiny

Kanlux	Kanlux	EAN		DKC SK bez DPH
VIDI CTC-5514-W	02790	5905339027900	biela	2,56 €
VIDI CTC-5514-AN	02795	5905339027955	antik	2,56 €
VIDI CTC-5514-C	02791	5905339027917	chróm	2,56 €
VIDI CTC-5514-C/M	02793	5905339027931	matný chróm	2,56 €

# VIDI CTC-5515

**Kanlux**

Podhľadové bodové svetidlo



31-33,  
54



196-197

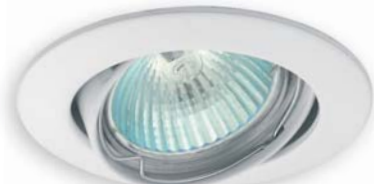
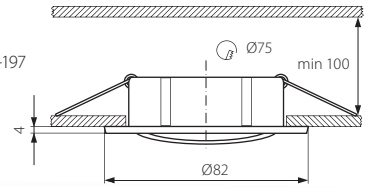

■ VIDI CTC-5515-W



■ VIDI CTC-5515-G

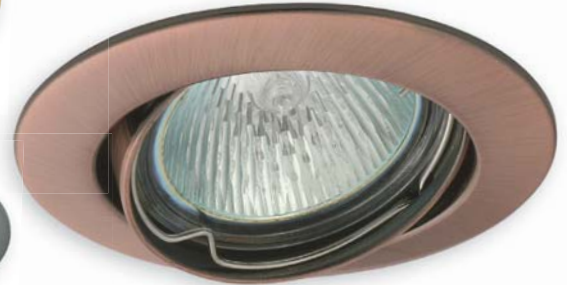

■ VIDI CTC-5515-AN



■ VIDI CTC-5515-C



■ VIDI CTC-5515-C/M

■ teleso svetidla: odliatok z hliníkovej zliatiny

Kanlux	Kanlux	EAN		DKC SK bez DPH
VIDI CTC-5515-W	02780	5905339027801	biela	3,55 €
VIDI CTC-5515-G	02786	5905339027863	zlatá	2,56 €
VIDI CTC-5515-AN	02785	5905339027856	antik	3,55 €
VIDI CTC-5515-C	02781	5905339027818	chróm	3,55 €
VIDI CTC-5515-C/M	02783	5905339027832	matný chróm	3,55 €

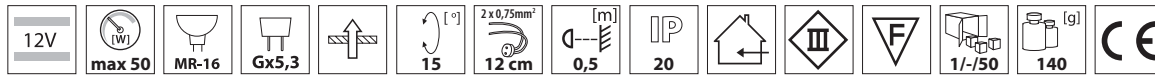

# BASK CTC-5514

Podhľadové bodové svetidlo



31-33,  
54



196-197

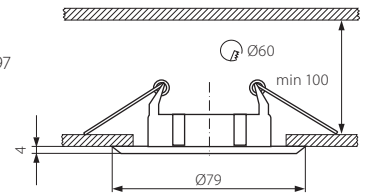

■ BASK CTC-5514-PG/N



■ BASK CTC-5514-SN/N



■ BASK CTC-5514-MPC/N



■ BASK CTC-5514-SN/G



■ BASK CTC-5514-SG/N

■ teleso svetidla: odliatok z hliníkovej zliatiny

Kanlux	Kanlux	EAN		DKC SK bez DPH
BASK CTC-5514-MPC/N	02814	5905339028143	matne perleťový chróm/nikel	3,85 €
BASK CTC-5514-PG/N	02810	5905339028105	perleťovo zlatá/nikel	3,85 €
BASK CTC-5514-SN/G	02813	5905339028136	saténový nikel/zlatá	3,85 €
BASK CTC-5514-SN/N	02816	5905339028167	saténový nikel/nikel	3,85 €
BASK CTC-5514-SG/N	02815	5905339028150	saténová zlatá/nikel	3,85 €

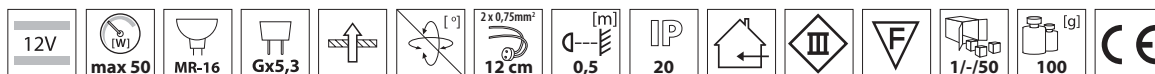





Podhľadové bodové svetidlo

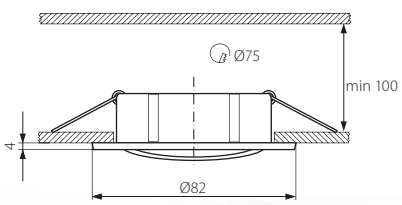

■ BASK CTC-5515-PG/N



■ BASK CTC-5515-MPC/N



■ BASK CTC-5515-SN/G



■ BASK CTC-5515-SN/N



■ BASK CTC-5515-SG/N

■ teleso svetidla: odliatok z hliníkovej zliatiny

Kanlux	Kanlux	EAN
BASK CTC-5515-MPC/N	02804	5905339028044
BASK CTC-5515-PG/N	02800	5905339028006
BASK CTC-5515-SN/G	02803	5905339028037
BASK CTC-5515-SN/N	02806	5905339028068
BASK CTC-5515-SG/N	02805	5905339028051

matne perletový chróm/nikel	DKC SK bez DPH
perletovo zlatá/nikel	5,01 €
saténový nikel/zlatá	5,01 €
saténový nikel/nikel	5,01 €
saténová zlatá/nikel	5,01 €

12V max 50 MR-16 Gx5,3 15 2x0,75mm<sup>2</sup> 12 cm 0,5 IP 20 1/-/50 140

Podhľadové bodové svetidlo

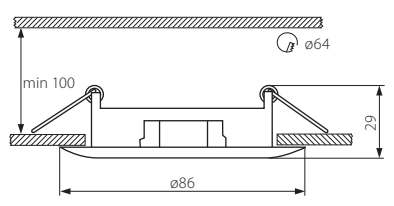

■ RODOS CT-DS09-AB



■ RODOS CT-DS09-SN



■ RODOS CT-DS09-C

■ teleso svetidla: odliatok z hliníkovej zliatiny

Kanlux	Kanlux	EAN
RODOS CT-DS09-AB	04685	5905339046857
RODOS CT-DS09-C	04686	5905339046864
RODOS CT-DS09-SN	04687	5905339046871

mosadz s patinou	DKC SK bez DPH
chróm	4,95 €
saténový nikel	3,62 €
	3,82 €

12V max 50 MR-16 Gx5,3 15 2x0,75mm<sup>2</sup> 12 cm 0,5 IP 20 1/-/50 95

# RODOS CT-DT09

**Kanlux**

Podhľadové bodové svetidlo

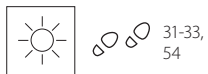

31-33,  
54



196-197

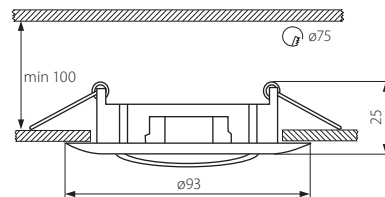

■ RODOS CT-DT09-AB



■ RODOS CT-DT09-C



■ RODOS CT-DT09-SN

■ teleso svetidla: odliatok z hliníkovej zliatiny

<b>Kanlux</b>	<b>Kanlux</b>	EAN
RODOS CT-DT09-AB	04688	5905339046888
RODOS CT-DT09-C	04689	5905339046895
RODOS CT-DT09-SN	04690	5905339046901



mosadz s patinou  
chróm  
saténový nikel

DKC SK  
bez DPH

6,14 €  
5,78 €  
6,14 €

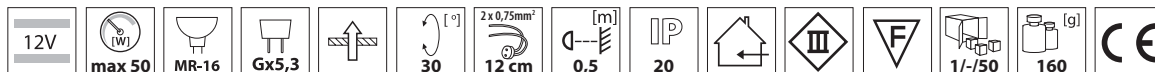

# NAVI CTX-DS10

Podhľadové bodové svetidlo

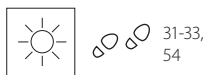

31-33,  
54

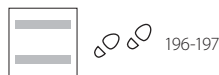

196-197

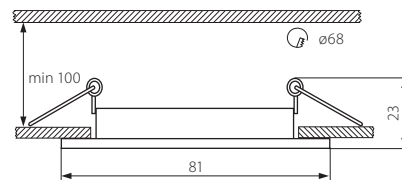

■ NAVI CTX-DS10-SN



■ NAVI CTX-DS10-C

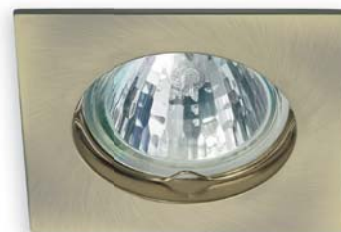

■ NAVI CTX-DS10-AB

■ teleso svetidla: odliatok z hliníkovej zliatiny

<b>Kanlux</b>	<b>Kanlux</b>	EAN
NAVI CTX-DS10-AB	04693	5905339046932
NAVI CTX-DS10-C	04694	5905339046949
NAVI CTX-DS10-SN	04695	5905339046956



mosadz s patinou  
chróm  
saténový nikel

DKC SK  
bez DPH

3,88 €  
3,68 €  
3,88 €

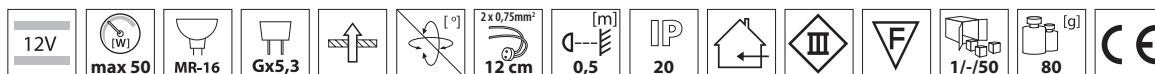

Podhľadové bodové svetidlo



■ NAVI CTX-DT10-C



31-33, 54



196-197



■ NAVI CTX-DT10-AB



■ NAVI CTX-DT10-W



■ NAVI CTX-DT10-C/M



■ NAVI CTX-DT10-G

■ teleso svetidla: odliatok z hliníkovej zliatiny

Kanlux	Kanlux	EAN
NAVI CTX-DT10-W	02550	5905339025500
NAVI CTX-DT10-G	02552	5905339025524
NAVI CTX-DT10-AB	02554	5905339025548
NAVI CTX-DT10-C	02551	5905339025517
NAVI CTX-DT10-C/M	02553	5905339025531



biela  
zlatá  
mosadz s patinou  
chróm  
matný chróm

DKC SK  
bez DPH

4,55 €  
5,58 €  
5,58 €  
5,58 €  
5,58 €

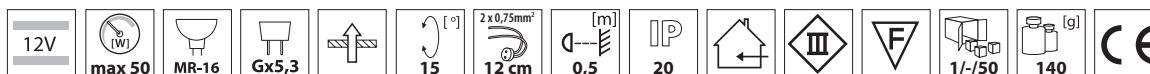

## TOSA CT-DS87-SN

Podhľadové bodové svetidlo

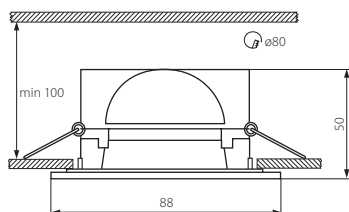

53



196-197



■ TOSA CT-DS87-SN

■ teleso svetidla: odliatok z hliníkovej zliatiny / difuzor: sklo / reflektor: hliník

Kanlux	Kanlux	EAN
TOSA CT-DS87-SN	04697	5905339046970



saténový nikel

DKC SK  
bez DPH

8,86 €

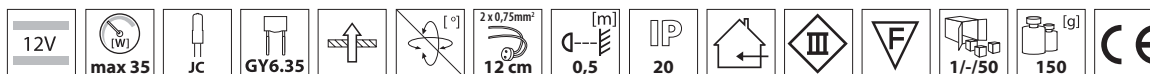

# RESO CTX-KW10



**Kanlux**

Podhľadové bodové svetidlo



53



196-197

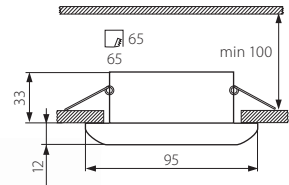

■ RESO CTX-KW10-AN



■ RESO CTX-KW10-C/M



■ RESO CTX-KW10-C



■ teleso svetidla: odliatok z hliníkovej zliatiny / difuzor: sklo / reflektor: hliník

		EAN 		DKC SK bez DPH
RESO CTX-KW10-AN	04325	5905339043252	antik	6,07 €
RESO CTX-KW10-C	04326	5905339043269	chróm	6,07 €
RESO CTX-KW10-C/M	04327	5905339043276	matný chróm	6,07 €

12V max 35 JC GY6.35 2x 0,75mm<sup>2</sup> 12 cm 0,5 IP 20 III F 1/-/50 42 g CE

# NOMA CTX-DS10G



**Kanlux**

Podhľadové bodové svetidlo



53



196-197

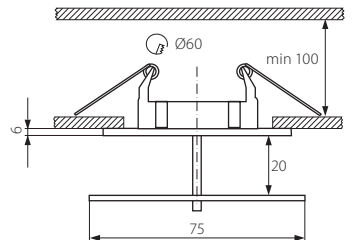

■ NOMA CTX-DS10G/B-C



■ NOMA CTX-DS10G/A-C



■ teleso svetidla: odliatok z hliníkovej zliatiny / difuzor: sklo

		EAN 		DKC SK bez DPH
NOMA CTX-DS10G/A-C	02561	5905339025616	chróm	8,00 €
NOMA CTX-DS10G/B-C	02566	5905339025661	chróm	8,00 €

12V max 50 MR-16 Gx5,3 2x 0,75mm<sup>2</sup> 12 cm 0,5 IP 20 III F 1/-/50 120 g CE



Podhľadové bodové svetidlo

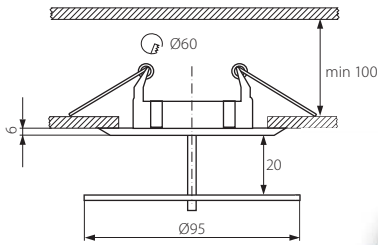

31-33, 54



196-197



■ DINO CTX-DS02G/A-C



■ DINO CTX-DS02G/B-C

■ teleso svetidla: odliatok z hliníkovej zliatiny / difuzor: sklo

		EAN 		DKC SK bez DPH
DINO CTX-DS02G/A-C	02571	5905339025715	chróm	6,87 €
DINO CTX-DS02G/B-C	02576	5905339025760	chróm	6,87 €

12V															
-----	--	--	--	--	--	--	--	--	--	--	--	--	--	--	--



Podhľadové bodové svetidlo

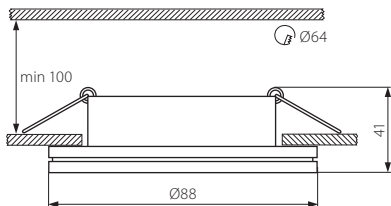

31-33, 54



196-197



■ RONA CT-AS11-AL

■ teleso svetidla: odliatok z hliníkovej zliatiny / difuzor: sklo

		EAN 		DKC SK bez DPH
RONA CT-AS11-AL	04700	5905339047007	hliník	12,65 €

12V															
-----	--	--	--	--	--	--	--	--	--	--	--	--	--	--	--

# TABO CT-AS02-AL

**Kanlux**

Podhľadové bodové svetidlo



31-33,  
54



196-197

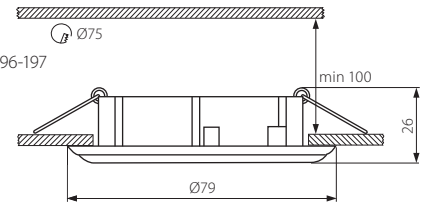

■ TABO CT-AS02-AL

teleso svetidla: hliník

**Kanlux**



EAN



hliník

DKC SK  
bez DPH

6,41 €

TABO CT-AS02-AL

04701

5905339047014

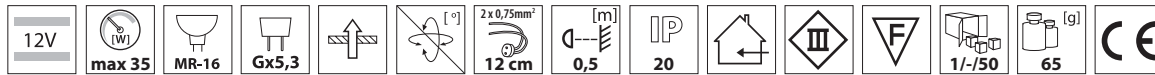

# AKRA CT-DS14

Podhľadové svetidlo ozdobné



31-33,  
54



196-197

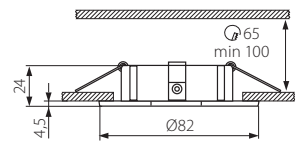

■ AKRA CT-DS14SN/G



■ AKRA CT-DS14PS/N

teleso svetidla: odliatok z hliníkovej zliatiny

**Kanlux**



EAN



perletovo strieborná/nikel  
saténový nikel/zlatá

DKC SK  
bez DPH

4,65 €

4,65 €

AKRA CT-DS14PS/N

04785

5905339047854

AKRA CT-DS14SN/G

04786

5905339047861

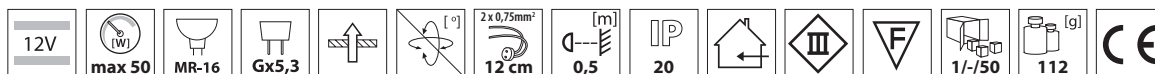



Podhľadové svetidlo ozdobné

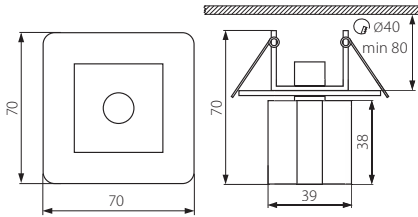

31-33, 54



196-197



DAVID CTX-20-SN

teleso svetidla: kovový výlisok / difuzor: sklo

		EAN 
DAVID CTX-20-SN	04965	5905339049650

saténový nikel

DKC SK bez DPH  
5,44 €

12V	max 20	JC	G4			2x0,5mm <sup>2</sup>	11 cm	0,5	IP 20			F	1/-/50	190 [g]	CE
-----	--------	----	----	--	--	----------------------	-------	-----	-------	--	--	---	--------	---------	----



Podhľadové svetidlo ozdobné

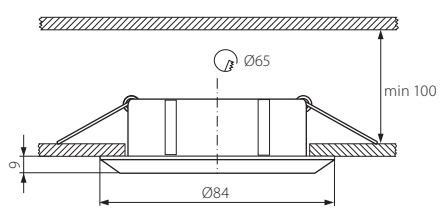

31-33, 54



196-197



RUBIX CTX-40+D-C



RUBIX CTX-40+B3-SN/N

teleso svetidla: odliatok z hliníkovej zliatiny / difuzor: sklo

		EAN 
RUBIX CTX-40+D-C	02862	5905339028624
RUBIX CTX-40+B3-SN/N	02863	5905339028631

chróm/priehľadný  
saténový nikel/nikel/priehľadný

DKC SK bez DPH  
4,51 €  
5,18 €

12V	max 50	MR-16	Gx5,3			2x0,75mm <sup>2</sup>	12 cm	0,5	IP 20			F	1/-/50	130 [g]	CE
-----	--------	-------	-------	--	--	-----------------------	-------	-----	-------	--	--	---	--------	---------	----

# GAVEL CTX-20

**Kanlux**

Podhľadové svietidlo ozdobné



31-33, 54



196-197

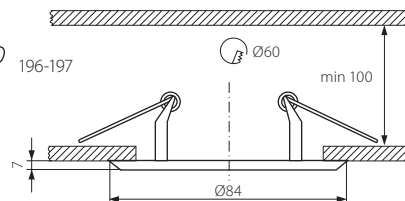

■ GAVEL CTX-20+B1-SN/G



■ GAVEL CTX-20+D-MPC/N



■ GAVEL CTX-20+B2-SN/N

■ teleso svietidla: kovový výlisok / difuzor: sklo

<b>Kanlux</b>	<b>Kanlux</b>	EAN		DKC SK bez DPH
GAVEL CTX-20+D-MPC/N	02880	5905339028808	matne perleťový chróm/nikel/priehľadný	3,45 €
GAVEL CTX-20+B1-SN/G	02882	5905339028822	saténový nikel/zlatá/žltá	3,45 €
GAVEL CTX-20+B2-SN/N	02881	5905339028815	saténový nikel/nikel/modrá	3,45 €

12V max 50 MR-16 Gx5,3 2x0,75mm<sup>2</sup> 12 cm 0,5 IP 20 III F 118 CE

# MIKA CTX-42

Podhľadové svietidlo ozdobné



31-33, 54



196-197

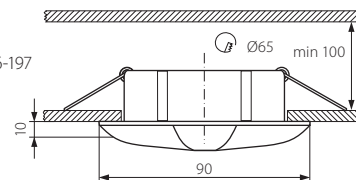

■ MIKA CTX-42+D-MPC/N



■ MIKA CTX-42+B2-SN/N

■ teleso svietidla: odliatok z hliníkovej zliatiny / difuzor: sklo

<b>Kanlux</b>	<b>Kanlux</b>	EAN		DKC SK bez DPH
MIKA CTX-42+D-MPC/N	02876	5905339028761	matne perleťový chróm/nikel/priehľadný	5,58 €
MIKA CTX-42+B2-SN/N	02875	5905339028754	saténový nikel/nikel/modrá	5,58 €

12V max 50 MR-16 Gx5,3 2x0,75mm<sup>2</sup> 12 cm 0,5 IP 20 III F 210 CE



Podhľadové svetidlo ozdobné

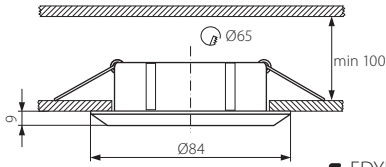

■ EDYP CTX-40+P-C



31-33,  
54



196-197



■ EDYP CTX-40+P-SN/N



■ teleso svetidla: odliatok z hliníkovej zliatiny / difuzor: sklo

		EAN 
EDYP CTX-40+P-C	02860	5905339028600
EDYP CTX-40+P-SN/N	02861	5905339028617



chróm/priehľadný  
saténový nikel/nikel/priehľadný

DKC SK  
bez DPH

4,51 €  
5,38 €

12V	max 50	MR-16	Gx5,3			2 x 0,75mm <sup>2</sup>	12 cm	0,5	IP 20				1/-/50	162 [g]	CE
-----	--------	-------	-------	--	--	-------------------------	-------	-----	-------	--	--	--	--------	---------	----

**DANTE CTX-41+D-C**

Podhľadové svetidlo ozdobné

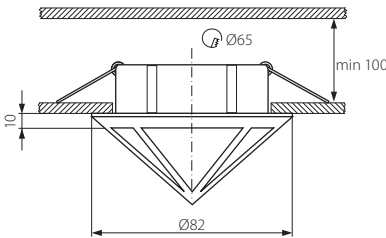

31-33,  
54



196-197



■ DANTE CTX-41+D-C

■ teleso svetidla: odliatok z hliníkovej zliatiny / difuzor: sklo

		EAN 
DANTE CTX-41+D-C	02871	5905339028716



chróm/priehľadný

DKC SK  
bez DPH

4,91 €

12V	max 50	MR-16	Gx5,3			2 x 0,75mm <sup>2</sup>	12 cm	0,5	IP 20				1/-/50	184 [g]	CE
-----	--------	-------	-------	--	--	-------------------------	-------	-----	-------	--	--	--	--------	---------	----

# TRISTAN CTX-10+K

**Kanlux**

Podhľadové svietidlo ozdobné



31-33, 54



196-197

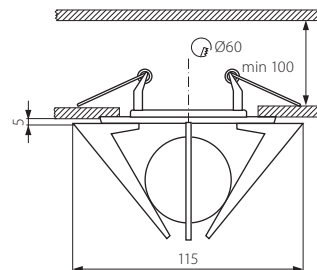

■ TRISTAN CTX-10+K1-C



■ TRISTAN CTX-10+K2-C

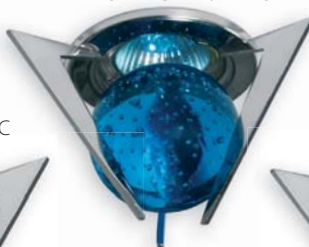

■ TRISTAN CTX-10+K4-C



■ TRISTAN CTX-10+K3-C

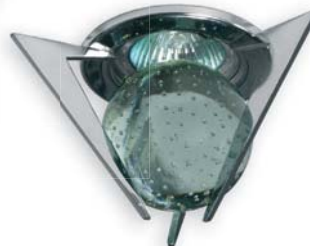

■ teleso svietidla: kovový výlisok / difuzor: sklo

<b>Kanlux</b>		EAN			DKC SK bez DPH
TRISTAN CTX-10+K1-C	02893	5905339028938	chróm/zltá		
TRISTAN CTX-10+K2-C	02890	5905339028907	chróm/modrá	6,71 €	
TRISTAN CTX-10+K4-C	02891	5905339028914	chróm/zelená	6,71 €	
TRISTAN CTX-10+K3-C	02892	5905339028921	chróm/priehľadný	6,71 €	

12V max 50 MR-16 Gx5,3 2x0,75mm<sup>2</sup> 12 cm 0,5 IP 20 III F 11-/20 390 CE

# IGLO CTX-30

Podhľadové svietidlo ozdobné



53



196-197

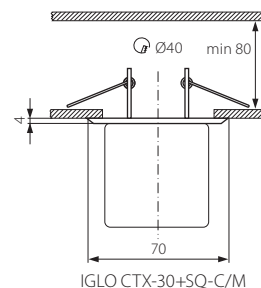

■ IGLO CTX-30+SQ-C/M



■ IGLO CTX-30+G-C/M

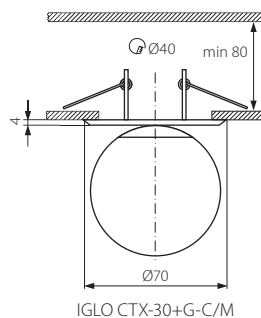

■ teleso svietidla: kovový výlisok / difuzor: sklo

<b>Kanlux</b>		EAN			DKC SK bez DPH
IGLO CTX-30+G-C/M	02895	5905339028952	matný chróm/biela		
IGLO CTX-30+SQ-C/M	02896	5905339028969	matný chróm/biela	190 4,71 €	

12V max 35 JC G4 2x0,75mm<sup>2</sup> 12 cm 0,5 IP 20 III F 11-/50 CE



Podhledové svetidlo s vyšším stupňom krytia

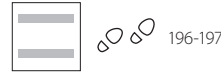
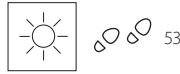
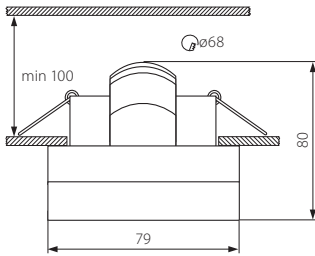

■ PERS CT-DS94-C/W

■ teleso svetidla: odliatok z hliníkovej zliatiny / difuzor: sklo

		EAN 
PERS CT-DS94-C/W	04702	5905339047021



DKC SK  
bez DPH  
15,00 €

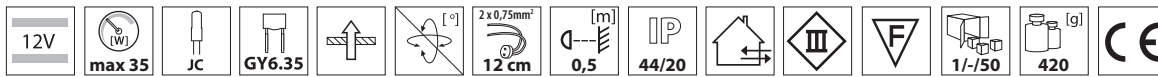

- zvýšená odolnosť proti vniknutiu vlhkosti a prachu
- určené k montáži do priestorov so zvýšenou vlhkosťou, napr. kúpeľní



Podhledové svetidlo s vyšším stupňom krytia

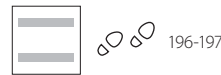
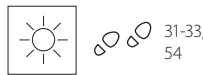
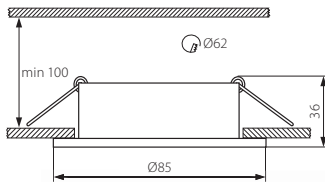

■ MARIN CT-S80-AB



■ MARIN CT-S80-C



■ MARIN CT-S80-SN

■ teleso svetidla: odliatok z hliníkovej zliatiny / difuzor: sklo

		EAN 
MARIN CT-S80-AB	04710	5905339047106
MARIN CT-S80-C	04703	5905339047038
MARIN CT-S80-SN	04704	5905339047045



DKC SK  
bez DPH  
4,08 €  
3,95 €  
4,08 €

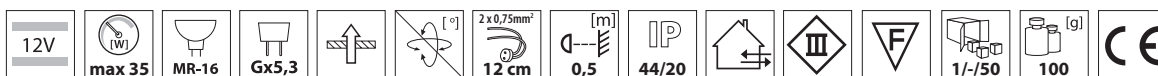

- zvýšená odolnosť proti vniknutiu vlhkosti a prachu
- určené k montáži do priestorov so zvýšenou vlhkosťou, napr. kúpeľní

# QULES CT-DS83-SN



**Kanlux**

Podhľadové svietidlo s vyšším stupňom krytia



31-33, 54



196-197



■ QULES CT-DS83-SN

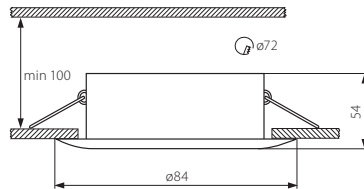

■ teleso svietidla: odliatok z hliníkovej zliatiny / difuzor: sklo

		EAN 
QULES CT-DS83-SN	04706	5905339047069



saténový nikel

DKC SK bez DPH

8,17 €

12V	max 35	MR-16	Gx5,3			2x 0,75mm <sup>2</sup>	12 cm	0,5	IP 44/20				11/-/50	144 [g]	CE
-----	--------	-------	-------	--	--	------------------------	-------	-----	----------	--	--	--	---------	---------	----

- zvýšená odolnosť proti vniknutiu vlhkosti a prachu
- určené k montáži do priestorov so zvýšenou vlhkosťou, napr. kúpeľní

# GLEN CT-DS82



Podhľadové svietidlo s vyšším stupňom krytia



31-33, 54



196-197



■ GLEN CT-DS82-AB



■ GLEN CT-DS82-C

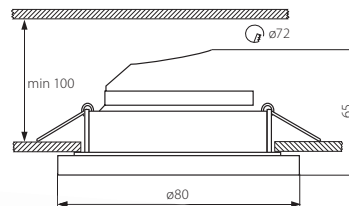

■ teleso svietidla: odliatok z hliníkovej zliatiny / difuzor: sklo

		EAN 
GLEN CT-DS82-AB	04711	5905339047113
GLEN CT-DS82-C	04707	5905339047076



mosadz s patinou  
chróm

DKC SK bez DPH

2,09 €

2,09 €

12V	max 35	MR-16	Gx5,3			2x 0,75mm <sup>2</sup>	12 cm	0,5	IP 44/20				11/-/50	112 [g]	CE
-----	--------	-------	-------	--	--	------------------------	-------	-----	----------	--	--	--	---------	---------	----

- zvýšená odolnosť proti vniknutiu vlhkosti a prachu
- určené k montáži do priestorov so zvýšenou vlhkosťou, napr. kúpeľní

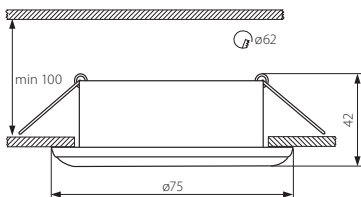

31-33,  
54



196-197

Podhledové svetidlo s vyšším stupňom krytia



■ VELO CT-AS83-AL

■ teleso svetidla: odliatok z hliníkovej zliatiny / difuzor: sklo

**Kanlux**

**Kanlux**

EAN



DKC SK  
bez DPH

VELO CT-AS83-AL

04709

5905339047090

hliník

2,09 €

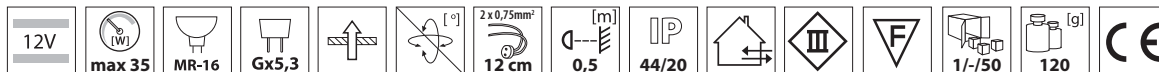

- zvýšená odolnosť proti vniknutiu vlhkosti a prachu
- určené k montáži do priestorov so zvýšenou vlhkosťou, napr. kúpeľní

## DELE AL-204

Podhledové bodové svetidlo

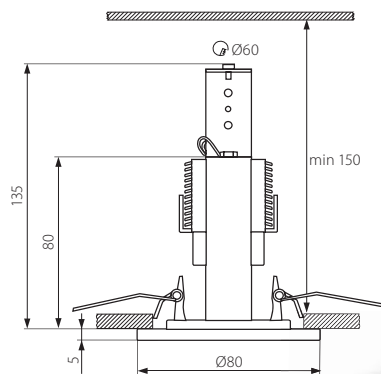

34-36,  
46, 52



■ DELE AL-204-C/M



■ DELE AL-204-C

■ teleso svetidla: kovový výlisok

**Kanlux**

**Kanlux**

EAN



DKC SK  
bez DPH

DELE AL-204-C

00911

5905339009111

chróm

4,85 €

DELE AL-204-C/M

00913

5905339009135

matný chróm

5,15 €

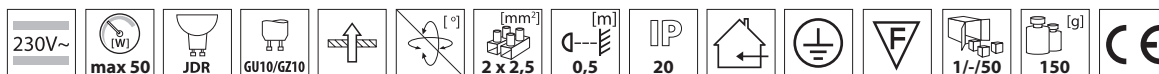

# DELE AL-205

**Kanlux**

Podhľadové bodové svetidlo



34-36,  
46,52



■ DELE AL-205-C



■ DELE AL-205-C/M

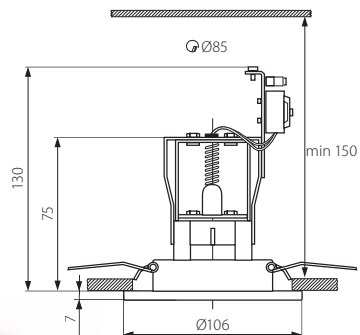

■ teleso svetidla: kovový výlisok

<b>Kanlux</b>	<b>Kanlux</b>	EAN
DELE AL-205-C	00921	5905339009210
DELE AL-205-C/M	00923	5905339009234



chróm  
matný chróm

DKC SK  
bez DPH

4,98 €  
5,15 €

230V~	max 50	JDR	GU10/GZ10	20	2 x 2,5	0,5	IP 20	IP 20	F	1/-/50	210	CE
-------	--------	-----	-----------	----	---------	-----	-------	-------	---	--------	-----	----

# TESON AL-DS

Podhľadové bodové svetidlo



34-36,  
46,52



■ TESON AL-DSL50



■ TESON AL-DSO50

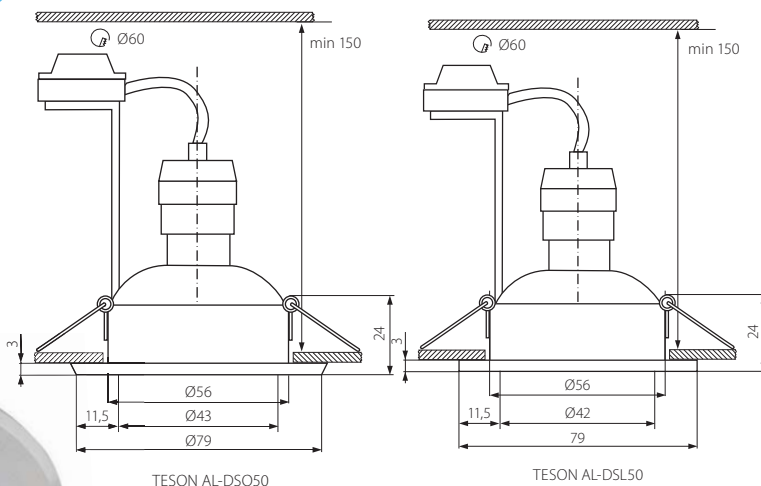

■ teleso svetidla: odliatok z hliníkovej zliatiny

<b>Kanlux</b>	<b>Kanlux</b>	EAN
TESON AL-DSO50	07372	5905339073723
TESON AL-DSL50	07373	5905339073730



hliník  
hliník

100  
112

DKC SK  
bez DPH

6 €  
6 €

230V~	50Hz	max 50	JDR	GU10	20	2 x 2,5	0,5	IP 20	IP 20	F	max 35	max 50	1/-/50	CE
-------	------	--------	-----	------	----	---------	-----	-------	-------	---	--------	--------	--------	----

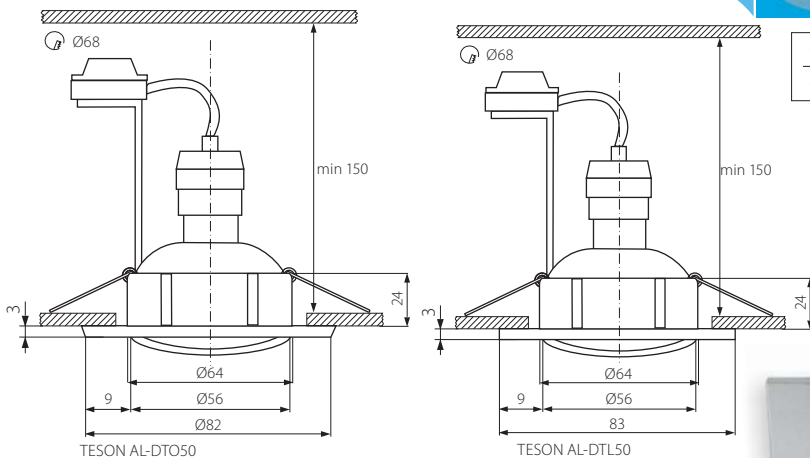

Podhládové bodové svetidlo



■ TESON AL-DT050



■ TESON AL-DTL50

■ teleso svetidla: odliatok z hliníkovej zliatiny

<b>NEW</b>	<b>Kanlux</b>	<b>Kanlux</b>	<b>EAN</b>			<b>DKC SK bez DPH</b>
<b>TESON AL-DT050</b>	07370	5905339073709	hliník	118	7,16 €	
<b>NEW</b>	<b>Kanlux</b>	<b>Kanlux</b>	<b>EAN</b>			<b>DKC SK bez DPH</b>
<b>TESON AL-DTL50</b>	07371	5905339073716	hliník	126	7,16 €	

230V~	50Hz	max 50	JDR	GU10		30	2 x 2,5	0,5	IP 20				1/-/50	
-------	------	--------	-----	------	--	----	---------	-----	-------	--	--	--	--------	--

## OZON DLBS-1AV/27



Podhládové bodové svetidlo

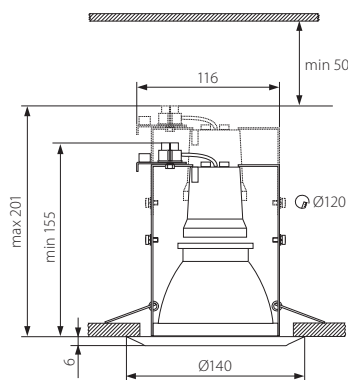

■ OZON DLBS-1AV/27-C



■ OZON DLBS-1AV/27-W



■ OZON DLBS-1AV/27-C/M

■ teleso svetidla: kovový výlisok / reflektor: hliník

<b>Kanlux</b>	<b>Kanlux</b>	<b>EAN</b>		<b>DKC SK bez DPH</b>
<b>OZON DLBS-1AV/27-W</b>	00905	5905339009050	biela	6,87 €
<b>OZON DLBS-1AV/27-C</b>	00907	5905339009074	chróm	7,73 €
<b>OZON DLBS-1AV/27-C/M</b>	00908	5905339009081	matný chróm	7,73 €

230V~	max 60		E27		30	2 x 2,5	0,5	IP 20				1/-/30	258	
-------	--------	--	-----	--	----	---------	-----	-------	--	--	--	--------	-----	--

# RAGO DL-R39

**Kanlux**

Podhľadové bodové svetidlo

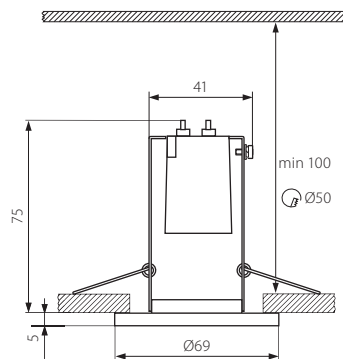
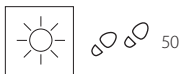

■ RAGO DL-R39-C/M



■ RAGO DL-R39-C

■ teleso svetidla: kovový výlisok

<b>Kanlux</b>	<b>Kanlux</b>	EAN		DKC SK bez DPH
RAGO DL-R39-C	01063	5905339010636	chróm	1,69 €
RAGO DL-R39-C/M	01064	5905339010643	matný chróm	1,69 €

230V~ max 30 R39 E14 3 x 1 0,5 IP 20 1/4/100 94 CE

# RAGO DL-R39T

Podhľadové bodové svetidlo

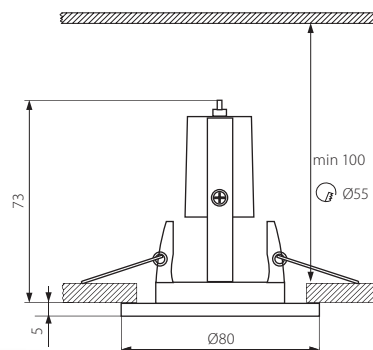
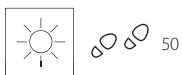

■ RAGO DL-R39T-AB



■ RAGO DL-R39T-C



■ RAGO DL-R39T-C/M

■ teleso svetidla: kovový výlisok

<b>Kanlux</b>	<b>Kanlux</b>	EAN		DKC SK bez DPH
RAGO DL-R39T-AB	01065	5905339010650	mosadz s patinou	2,36 €
RAGO DL-R39T-C	01068	5905339010681	chróm	2,12 €
RAGO DL-R39T-C/M	01069	5905339010698	matný chróm	2,12 €

230V~ max 30 R39 E14 15 3 x 1 0,5 IP 20 1/4/100 110 CE



Podhľadové bodové svetidlo

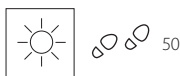
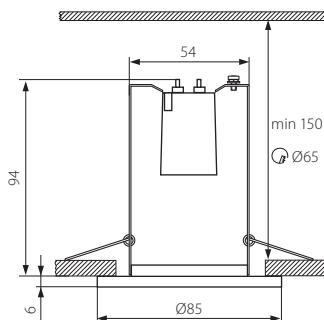

■ RAGO DL-R50-C



■ RAGO DL-R50-AB



■ RAGO DL-R50-W



■ RAGO DL-R50-G



■ RAGO DL-R50-C/M

■ teleso svetidla: kovový výlisok

Kanlux	Kanlux	EAN
RAGO DL-R50-W	01071	5905339010711
RAGO DL-R50-G	01072	5905339010728
RAGO DL-R50-AB	01070	5905339010704
RAGO DL-R50-C	01073	5905339010735
RAGO DL-R50-C/M	01074	5905339010742

  
 biela  
 zlatá  
 mosadz s patinou  
 chróm  
 matný chróm

DKC SK  
 bez DPH  
 1,86 €  
 2,42 €  
 2,39 €  
 2,42 €  
 2,52 €

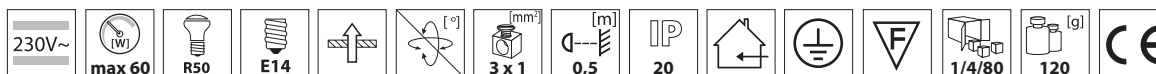

## BONI DL-RD50

Podhľadové bodové svetidlo

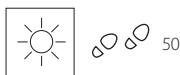
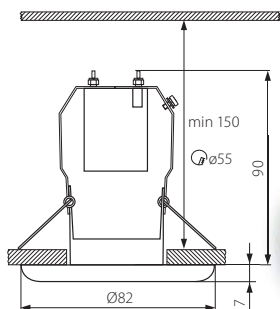

■ BONI DL-RD50-PS/G



■ BONI DL-RD50-SN/G



■ BONI DL-RD50-PG/N



■ BONI DL-RD50-SN/N

■ teleso svetidla: kovový výlisok

Kanlux	Kanlux	EAN
BONI DL-RD50-PG/N	04921	5905339049216
BONI DL-RD50-PS/G	04920	5905339049209
BONI DL-RD50-SN/G	04922	5905339049223
BONI DL-RD50-SN/N	04923	5905339049230

  
 perletovo zlatá/nikel  
 perletovo strieborná/zlatá  
 saténový nikel/zlatá  
 saténový nikel/nikel

DKC SK  
 bez DPH  
 3,49 €  
 3,49 €  
 3,49 €  
 3,15 €

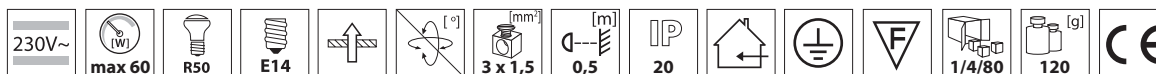

# RAGO DL-R50E

**Kanlux**

Podhľadové bodové svetidlo

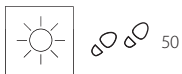

■ RAGO DL-R50E-C/M



■ RAGO DL-R50E-C

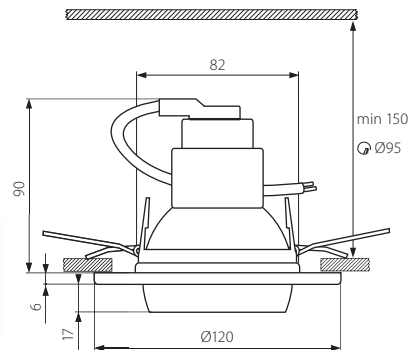

■ teleso svetidla: kovový výlisok

<b>Kanlux</b>	<b>Kanlux</b>	EAN 5905339010780	chróm	DKC SK bez DPH 5,48 €
RAGO DL-R50E-C	01078	5905339010780	matný chróm	5,91 €
RAGO DL-R50E-C/M	01077	5905339010773		

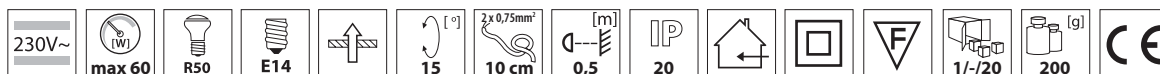

# VABI DL-RS50

Podhľadové bodové svetidlo

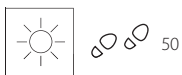

■ VABI DL-RS50-C



■ VABI DL-RS50-C/M

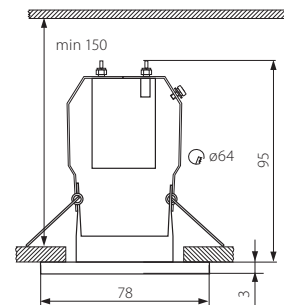

■ teleso svetidla: kovový výlisok

<b>Kanlux</b>	<b>Kanlux</b>	EAN 5905339049308	chróm	DKC SK bez DPH 2,66 €
VABI DL-RS50-C	04930	5905339049308	matný chróm	2,66 €
VABI DL-RS50-C/M	04931	5905339049315		

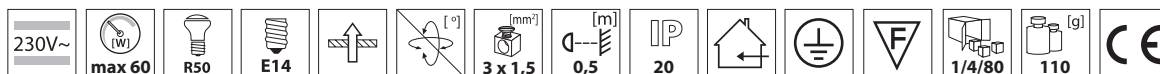



Podhľadové bodové svetidlo

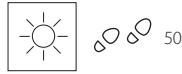
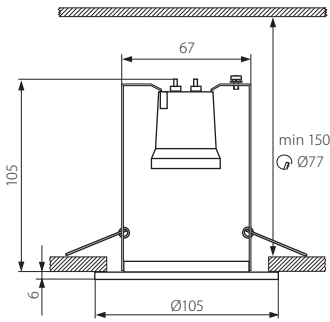

■ RAGO DL-R63-C/M



■ RAGO DL-R63-W



■ RAGO DL-R63-C

■ teleso svetidla: kovový výlisok

<b>Kanlux</b>		EAN
RAGO DL-R63-W	01081	5905339010810
RAGO DL-R63-C	01083	5905339010834
RAGO DL-R63-C/M	01084	5905339010841



biela  
chróm  
matný chróm

DKC SK  
bez DPH

2,02 €  
2,69 €  
2,79 €

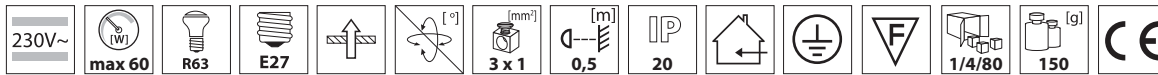

# ELSE CT-2116C

**Kanlux**

Podhľadové bodové svetidlo



52



196-197

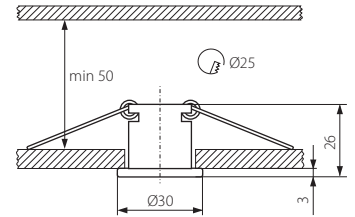

■ ELSE CT-2116C-G



■ ELSE CT-2116C-C/M



■ ELSE CT-2116C-C



■ teleso svetidla: odliatok z hliníkovej zliatiny

**Kanlux**

**Kanlux**

EAN



DKC SK  
bez DPH

ELSE CT-2116C-G

00823

5905339008237

zlatá

2,02 €

ELSE CT-2116C-C

00821

5905339008213

chróm

2,02 €

ELSE CT-2116C-C/M

00825

5905339008251

matný chróm

2,16 €

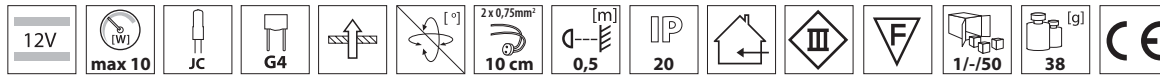

# SEDNA CTX-A20

Podhľadové bodové svetidlo



52



196-197

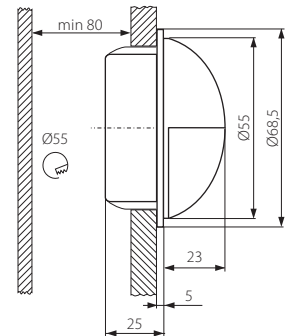

■ SEDNA CTX-A20AB



■ SEDNA CTX-A20C/M

■ teleso svetidla: kovový výlisok / difuzor: sklo

**Kanlux**

**Kanlux**

EAN



DKC SK  
bez DPH

NEW

SEDNA CTX-A20AB

04978

5905339049780

mosadz s patinou

4,98 €

NEW

SEDNA CTX-A20C/M

04977

5905339049773

matný chróm

4,98 €

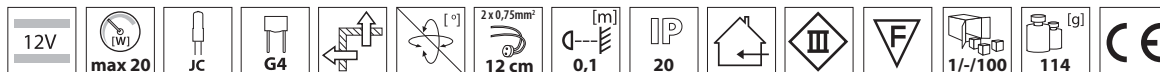



Podhládové bodové svetidlo

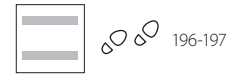
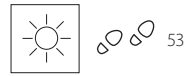
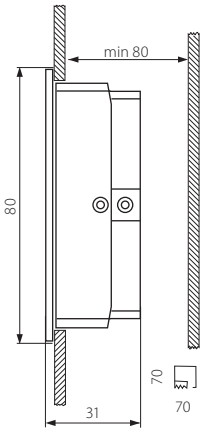

■ GORAN CT-J22 C/M



■ GORAN CT-J22 MGR

teleso svetidla: kovový výlisok / reflektor: hliník

NEW	<b>Kanlux</b>	<b>Kanlux</b>	EAN		DKC SK bez DPH
	GORAN CT-J22 C/M	04679	5905339046796		
	GORAN CT-J22 MGR	04699	5905339046994	šedá metalíza	5,01 €



Nábytkové bodové svetidlo

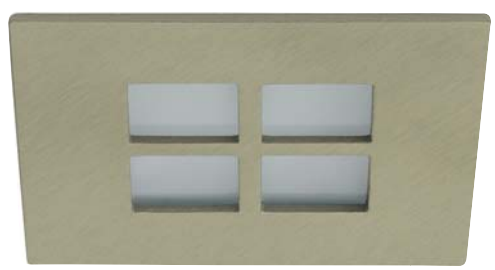
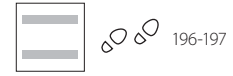
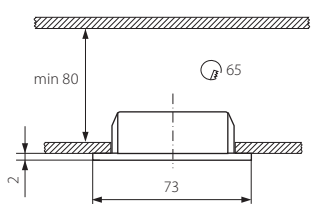

■ ALTER CTX-50+04-AB

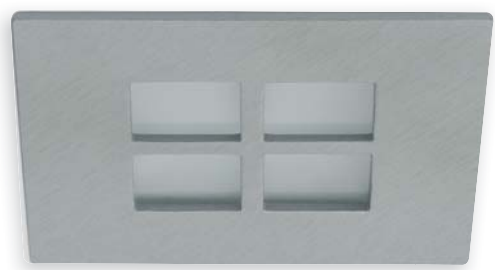

■ ALTER CTX-50+04-C/M

čelný panel: odliatok z hliníkovej zliatiny / difuzor: sklo / vnútorná krabička: oceľový plech / reflektor: hliník

NEW	<b>Kanlux</b>	<b>Kanlux</b>	EAN		DKC SK bez DPH
	ALTER CTX-50+04-AB	02899	5905339028990		
	ALTER CTX-50+04-C/M	02897	5905339028976	matný chróm	3,85 €

# GAVI CT-2116B

**Kanlux**

Nábytkové bodové svetidlo



■ GAVI CT-2116B-BR/M



52



196-197

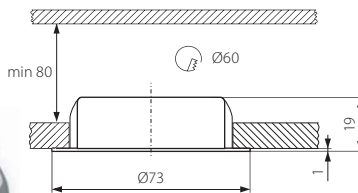

■ GAVI CT-2116B-W



■ GAVI CT-2116B-C



■ GAVI CT-2116B-AN



■ GAVI CT-2116B-G



■ GAVI CT-2116B-C/M

■ teleso svetidla a reflektor: kovový výlisok / difuzor: sklo

Kanlux	Kanlux	EAN	■ GAVI CT-2116B-AN	■ GAVI CT-2116B-G	DKC SK bez DPH
GAVI CT-2116B-W	00810	5905339008107	biela		2,82 €
GAVI CT-2116B-G	00813	5905339008138	zlatá		3,19 €
GAVI CT-2116B-BR/M	00814	5905339008145	matná mosadz		3,35 €
GAVI CT-2116B-AN	00817	5905339008176	antik		3,35 €
GAVI CT-2116B-C	00811	5905339008114	chróm		3,19 €
GAVI CT-2116B-C/M	00815	5905339008152	matný chróm		3,35 €

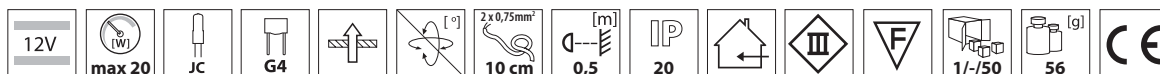

# GAVI LED-2116B

Nábytkové svetidlo LED



■ GAVI LED-2116B-C/M-27



196-197 (svetidlo iba pre transformátory TRETO a OTON)

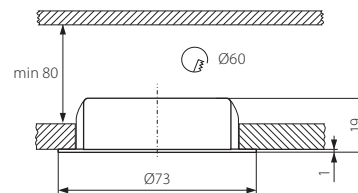

■ GAVI LED-2116B-C-27



■ teleso svetidla: kovový výlisok / difuzor: sklo

Kanlux	Kanlux	EAN	■ GAVI LED-2116B-C-27	■ GAVI LED-2116B-C-27	DKC SK bez DPH
GAVI LED-2116B-C-27	04266	5905339042668	chróm	teplá bilá	14,34 €
GAVI LED-2116B-C/M-27	04265	5905339042651	matný chróm	teplá bilá	14,34 €

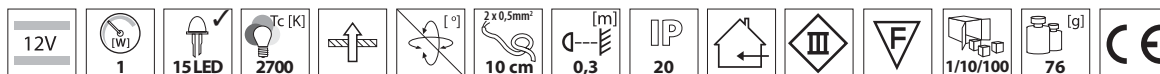

■ nevymenný zdroj svetla

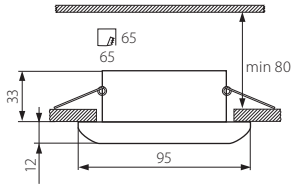

196-197 (svietidlo iba pre transformátory TRETO a OTON)

Nástenné bodové svetidlo LED

■ RESO POWER LED

■ teleso svetidla: odliatok z hliníkovej zliatiny / difuzor: sklo / reflektor: hliník

NEW	<b>Kanlux</b>	<b>Kanlux</b>	EAN 5905339077202	saténový chróm	teplá biela	DKC SK 11,52 €			
	RESO POWER LED	07720							
DC 350mA	max 1	1 POWER LED	Tc (K) 2700-3200	2x0,5mm <sup>2</sup> 10 cm	[m] 0,1	IP 20	1/48	210	CE

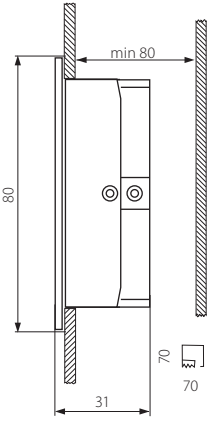

196-197 (svietidlo iba pre transformátory TRETO a OTON)

Nástenné bodové svetidlo LED

■ GORAN POWER LED

■ teleso svetidla: kovový výlisok / reflektor: hliník

NEW	<b>Kanlux</b>	<b>Kanlux</b>	EAN 5905339077103	saténový chróm	teplá biela	DKC SK 11,52 €			
	GORAN POWER LED	07710							
DC 350mA	max 1	1 POWER LED	Tc (K) 2700-3200	2x0,5mm <sup>2</sup> 10 cm	[m] 0,1	IP 20	1/48	120	CE

# SEDNA POWER LED

**Kanlux**

Nástenné bodové svetidlo LED



196-197 (svetidlo iba pre transformátory TRETO a OTON)

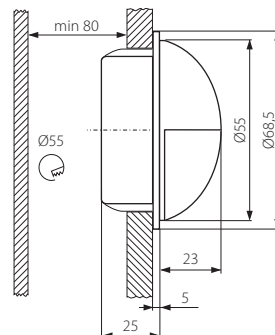

■ SEDNA POWER LED

■ teleso svetidla: kovový výlisok / difuzor: sklo

**Kanlux**

**Kanlux**

EAN



5905339077004



saténový chróm



teplá biela

DKC SK

11,52 €

NEW

SEDNA POWER LED

07700

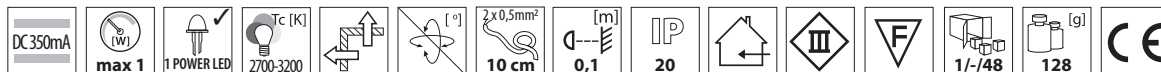

# KSENIA DL-POWER LED

Nástenné bodové svetidlo LED



196-197 (svetidlo iba pre transformátory TRETO a OTON)

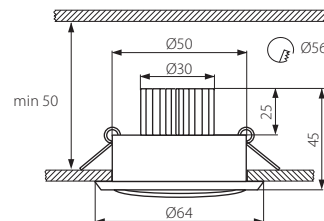

■ KSENIA DL-POWER LED

■ teleso svetidla: odliatok z hliníkovej zliatiny

**Kanlux**

**Kanlux**

EAN



5905339073501



saténový chróm



teplá biela

DKC SK

20,74 €

NEW

KSENIA DL-POWER LED

07350

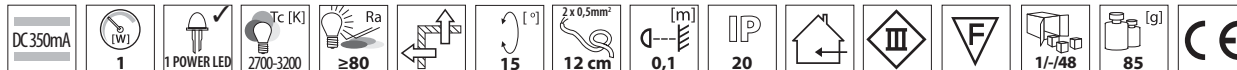



Nástenné bodové svetidlo LED

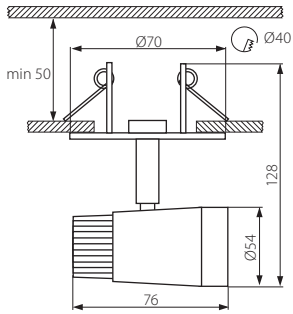

196-197 (svetidlo iba pre transformátory TRETO a OTON)



■ FERRA DL-3POWER LED



■ teleso svetidla: odliatok z hliníkovej zliatiny

NEW	<b>Kanlux</b>	<b>Kanlux</b>	EAN 5905339073518	saténový chróm	teplá biela	DKC SK 35,19 €						
	FERRA DL-3POWER LED	07351										
DC350mA	3	3 POWER LED	Tc [K] 2700-3200	Ra ≥80	90°	360°	2 x 0,5mm <sup>2</sup>	0,1 [m]	IP 20	1/48	260 [g]	CE

## PRO DR-16B

Distančný krúžok

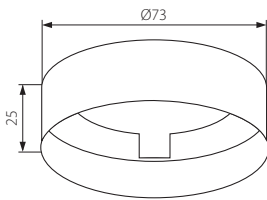

■ PRO DR-16B-C



■ PRO DR-16B-C/M



■ PRO DR-16B-BR/M

■ materiál: kovový výlisok

<b>Kanlux</b>	<b>Kanlux</b>	EAN	matná mosadz	DKC SK bez DPH
PRO DR-16B-BR/M	72192	5905339721921	chróm	1,46 €
PRO DR-16B-C	72111	5905339721112	matný chróm	1,29 €
PRO DR-16B-C/M	72139	5905339721396		1,29 €

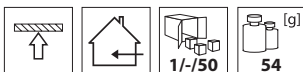

■ slúži k povrchovej montáži nábytkových svetiel GAVI CT-2116B i GAVI LED-2116B



Interiérová svietidlá

## GOLBA SX065 20W

Kancelárska stolná lampička

■ GOLBA SX065 20W-GND/T

■ GOLBA SX065 20W-PU/T

■ GOLBA SX065 20W-W/T



■ GOLBA SX065 20W-W

■ GOLBA SX065 20W-BLN/T

■ GOLBA SX065 20W-B/T

- teleso svietidla a tienidlo: plast / rameno a reflektor: hliník / difuzor: sklo
- teleskopické rameno
- transformátor vstavaný v podstavci

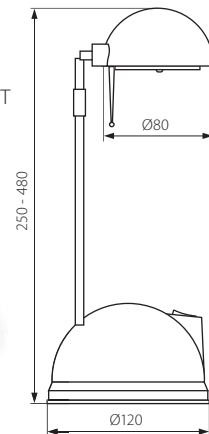

Kanlux	Kanlux	EAN	
GOLBA SX065 20W-W	01827	5905339018274	biela
GOLBA SX065 20W-W/T	01829	5905339018298	biela metalíza
GOLBA SX065 20W-B	01826	5905339018267	čierna
GOLBA SX065 20W-B/T	01828	5905339018281	čierna metalíza
GOLBA SX065 20W-GND/T	01842	5905339018427	zelená metalíza
GOLBA SX065 20W-BLN/T	01841	5905339018410	modrá metalíza
GOLBA SX065 20W-GF/T	01843	5905339018434	šedá metalíza
GOLBA SX065 20W-PU/T	01844	5905339018441	fialová metalíza



■ GOLBA SX065 20W-B

DKC SK bez DPH

- 8,30 €
- 8,30 €
- 8,30 €
- 8,30 €
- 8,30 €
- 8,30 €
- 8,30 €
- 8,30 €



■ GOLBA SX065 20W-GF/T

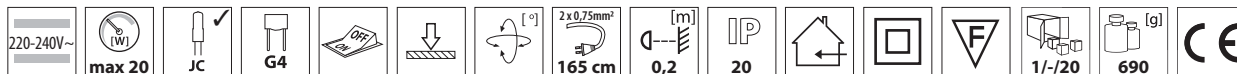

Kancelárska stolná lampička

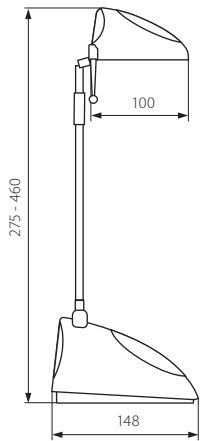

- Neli SX388 35W-B/T
- Neli SX388 35W-BLN/T
- Neli SX388 35W-PU/T
- Neli SX388 35W-W/T
- Neli SX388 35W-GND/T
- Neli SX388 35W-GF/T

- teleso svietidla a tienidlo: plast / rameno a reflektor: hlinik / difuzor: sklo
- teleskopické rameno
- transformátor vstavaný v podstavci



■ Neli SX388 35W-B

Kanlux	Kanlux	EAN		DKC SK bez DPH
Neli SX388 35W-B	01852	5905339018526	černá / čierna	9,49 €
Neli SX388 35W-W/T	01855	5905339018557	bielá metalíza	9,49 €
Neli SX388 35W-B/T	01854	5905339018540	čierná metalíza	9,49 €
Neli SX388 35W-GND/T	01868	5905339018687	zelená metalíza	9,49 €
Neli SX388 35W-BLN/T	01867	5905339018670	modrá metalíza	9,49 €
Neli SX388 35W-GF/T	01869	5905339018694	šedá metalíza	9,49 €
Neli SX388 35W-PU/T	01870	5905339018700	fiolová metalíza	9,49 €

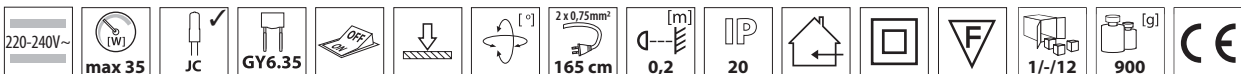

## MADRE SX2037

Kancelárska stolná lampička

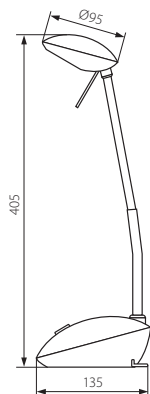

- Madre SX2037 GN/T
- Madre SX2037 GF/T
- Madre SX2037 RE/T
- Madre SX2037 BLN/T
- Madre SX2037 GFD/T

- teleso svietidla a tienidlo: plast / rameno a reflektor: hlinik / difuzor: sklo
- ohybná horná časť ramena
- transformátor vstavaný v podstavci

Kanlux	Kanlux	EAN		DKC SK bez DPH
Madre SX2037 GN/T	01930	5905339019301	zelená metalíza	13,97 €
Madre SX2037 BLN/T	01931	5905339019318	modrá metalíza	13,97 €
Madre SX2037 BLN/TR	01935	5905339019356	modrá priehľadná	13,97 €
Madre SX2037 GF/T	01933	5905339019332	šedá metalíza	13,97 €
Madre SX2037 GFD/T	01934	5905339019349	čierny chróm	13,97 €
Madre SX2037 RE/T	01932	5905339019325	červená metalíza	13,97 €

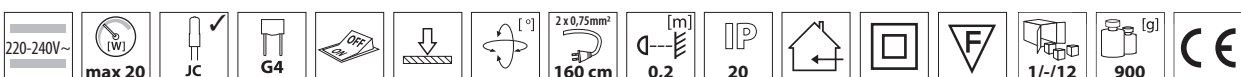

■ Madre SX2037 BLN/TR

# LORA HR-DF5

**Kanlux**

Kancelárska stolná lampička



28-31,  
37-45

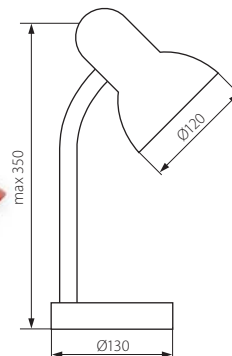

- LORA HR-DF5-GN
- LORA HR-DF5-W
- LORA HR-DF5-B
- LORA HR-DF5-BLN
- LORA HR-DF5-RE

■ teleso svietidla a tienidlo: ocelový plech / rameno a základna svietidla: plast

■ ohybné rameno

Kanlux	Kanlux	EAN		DKC SK bez DPH
LORA HR-DF5-W	01912	5905339019127	biela	6,34 €
LORA HR-DF5-B	01914	5905339019141	čierna	6,34 €
LORA HR-DF5-GN	01913	5905339019134	zelená	6,34 €
LORA HR-DF5-BLN	01910	5905339019103	modrá	6,34 €
LORA HR-DF5-RE	01911	5905339019110	červená	6,34 €

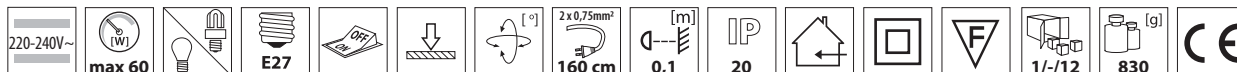

# ZARA HR-40

Kancelárska stolná lampička



28-31,  
37-45



■ ZARA HR-40-SR



■ ZARA HR-40-B



■ ZARA HR-40-BL



■ ZARA HR-40-OR

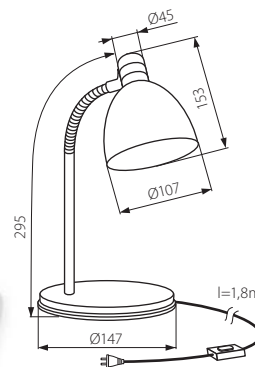

■ teleso, difúzor a rameno: ocelový plech / spodná časť telesa: plast

■ ohybná horná časť ramena

Kanlux	Kanlux	EAN		DKC SK bez DPH
ZARA HR-40-B	07561	5905339075611	čierna	8,89 €
ZARA HR-40-BL	07562	5905339075628	modrá	8,89 €
ZARA HR-40-OR	07563	5905339075635	oranžový	8,89 €
ZARA HR-40-SR	07560	5905339075604	strieborná	8,89 €



Kancelárska stolná lampička

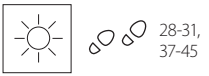
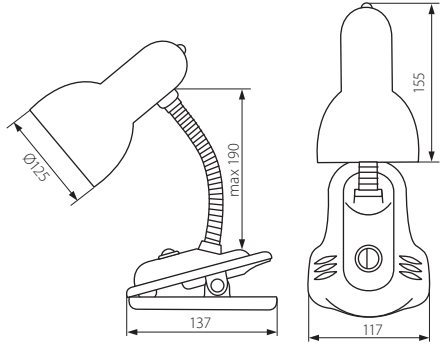

- teleso a konzola: plast / tienidlo: lakovaný oceľový plech
- ohybné rameno
- montáž pomocou svorky

Kanlux	Kanlux	EAN
SUZI HR-60-B	07151	5905339071514
SUZI HR-60-BL	07152	5905339071521
SUZI HR-60-SR	07150	5905339071507
SUZI HR-60-PK	07153	5905339071538



- čierna
- modrá
- strieborná
- ružová

DKC SK bez DPH

- 7,80 €
- 7,80 €
- 7,80 €
- 7,80 €

230V~ max 60 E27 OFF ON 2x0,75mm<sup>2</sup> 180 cm 0,2 IP 20 1/-/20 580 g CE

## MIRON KT040-GF/T

Kancelárska stolná lampička

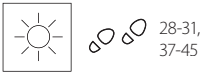
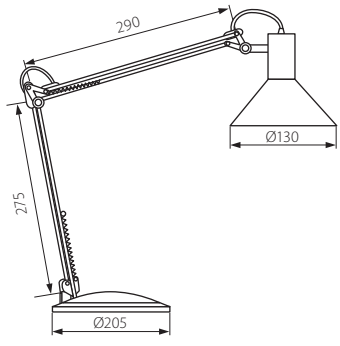

MIRON KT040-GF/T

- teleso: oceľový plech / tienidlo: lakovaný oceľový plech

Kanlux	Kanlux	EAN
MIRON KT040-GF/T	07200	5905339072009



šedá metalíza

DKC SK bez DPH

16,43 €

230V~ max 40 E14 OFF ON 2x0,75mm<sup>2</sup> 190 cm 0,2 IP 20 1/-/8 1590 g CE

# BRAS KT-18-SR

**Kanlux**

Kancelárska stolná lampička

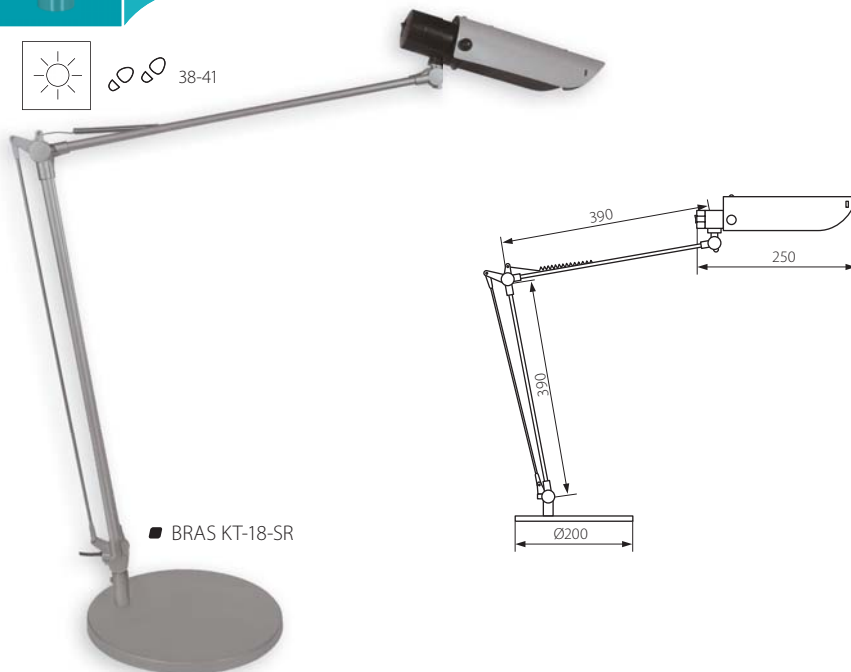
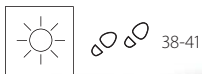

■ BRAS KT-18-SR

■ teleso a tienidlo: lakovaný oceľový plech / konzola: hliník

		EAN 		DKC SK bez DPH
BRAS KT-18-SR	07160	5905339071606	strieborná	24,90 €

# IBIS KT030

Kancelárska stolná lampička

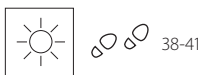

■ IBIS KT030-GN

■ IBIS KT030-GR

■ IBIS KT030-BL

■ teleso svetidla a rameno: kov / tienidlo a horný diel podstavca: plast / reflektor: hliník

		EAN 		DKC SK bez DPH
IBIS KT030-GN	01882	5905339018823	zelená	19,42 €
IBIS KT030-BL	01881	5905339018816	modrá	19,42 €
IBIS KT030-GR	01883	5905339018830	šedá	19,42 €

Kancelárska stolná lampa

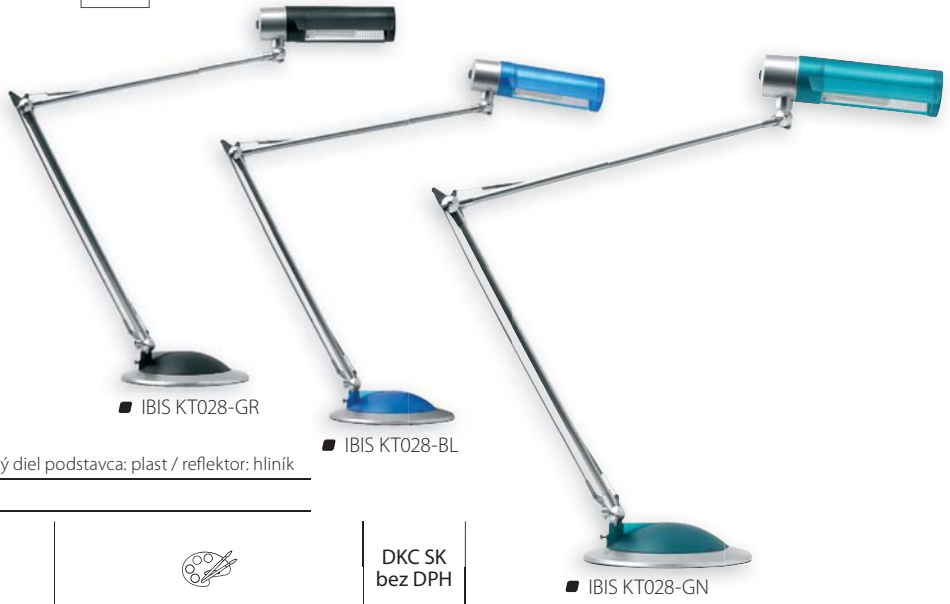
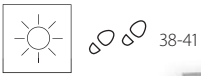
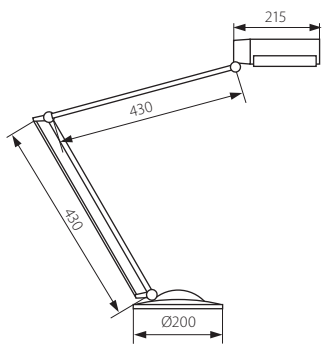

- teleso svetidla a rameno: kov / tienidlo a horný diel podstavca: plast / reflektor: hliník
- kĺbové rameno

<b>Kanlux</b>		EAN		DKC SK bez DPH
IBIS KT028-BL	01886	5905339018861	modrá	19,42 €
IBIS KT028-GR	01888	5905339018885	šedá	19,42 €
IBIS KT028-GN	01887	5905339018878	zelená	19,42 €

220-240V~ max 20 COMPACT E27 OFF ON 2x0,75mm<sup>2</sup> 175 cm 0,1 IP 20 1/-16 2500 [g] CE

## IBIS KT028C

Kancelárska stolná lampa

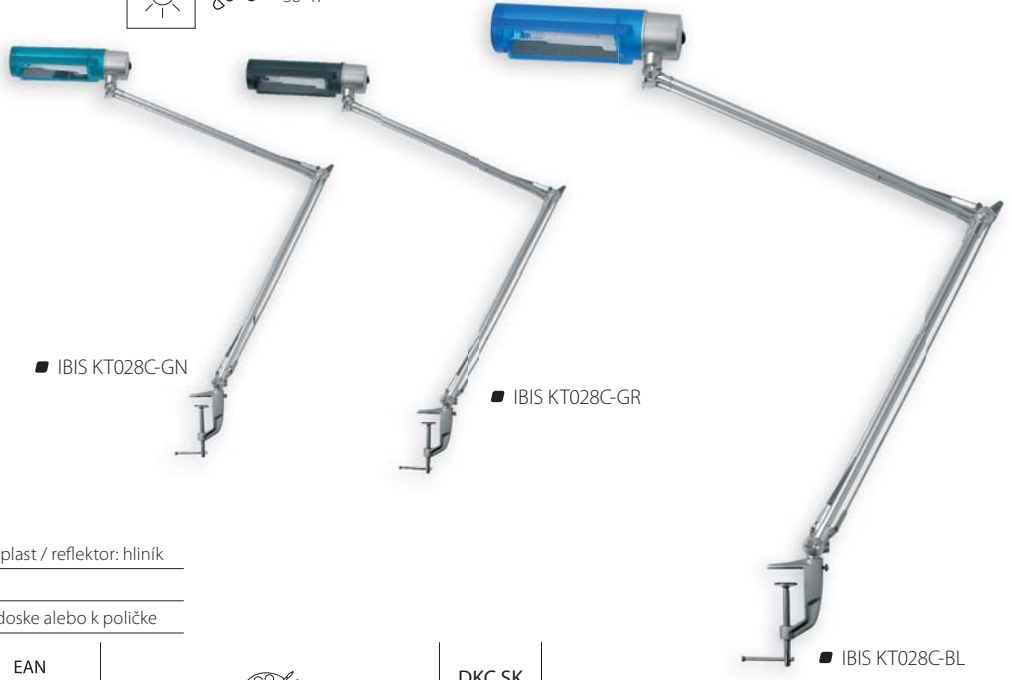
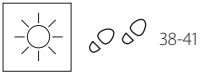
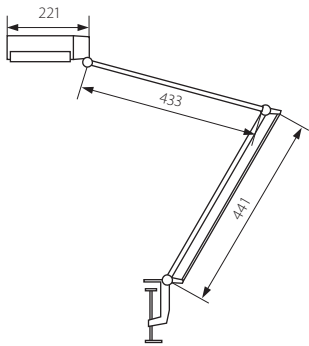

- držiak svetidla a rameno: kov / tienidlo: plast / reflektor: hliník
- kĺbové rameno
- so sponou umožňujúcou prichytenie k doske alebo k poličke

<b>Kanlux</b>		EAN		DKC SK bez DPH
IBIS KT028C-GN	01872	5905339018724	zelená	12,95 €
IBIS KT028C-BL	01871	5905339018717	modrá	12,95 €
IBIS KT028C-GR	01873	5905339018731	šedá	12,95 €

220-240V~ max 20 COMPACT E27 OFF ON 2x0,75mm<sup>2</sup> 175 cm 0,1 IP 20 1/-12 510 [g] CE

# HERON KT017C

**Kanlux**

Kancelárska stolná lampička



■ HERON KT017C-W

■ HERON KT017C-B

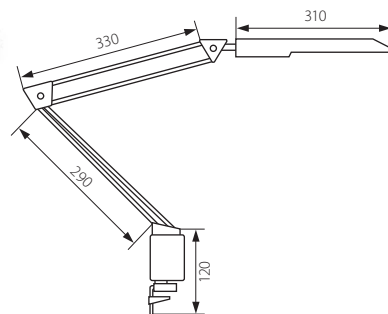

- držiak svietidla a rameno: kov / tienidlo: plast / reflektor: hliník
- kĺbové rameno
- so sponou umožňujúcou prichytenie k doske alebo k poličke

		EAN 		DKC SK bez DPH
HERON KT017C-W	01878	5905339018786	biela	13,81 €
HERON KT017C-B	01879	5905339018793	čierna	13,81 €

--	--	--	--	--	--	--	--	--	--	--	--	--	--	--	--

# SAXO LED KT-58

Dekoračné svietidlo LED



■ SAXO LED KT-58

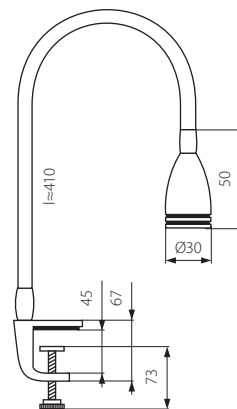

- teleso: ocelový plech / ochranný difuzor: plast
- svietidlo obsahuje transformátor LED, ktorý je priamo napojený na prívod svietidla
- so sponou umožňujúcou prichytenie k doske alebo k poličke



		EAN 			DKC SK bez DPH
NEW SAXO LED KT-58	07520	5905339075208	strieborná	biela	26,44 €

--	--	--	--	--	--	--	--	--	--	--	--	--	--	--	--



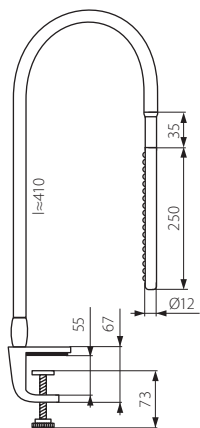

■ CARI LED18 KT-87

- teleso: ocelový plech
- svetidlo obsahuje transformátor LED, ktorý je priamo napojen na prívod svetidla
- so sponou umožňujúcou prichytenie k doske alebo k poľičke

NEW	<b>Kanlux</b>	<b>Kanlux</b>	EAN 5905339077608	strieborná	biela	DKC SK bez DPH 28,67 €								
	CARI LED18 KT-87	07760												
220-240V~	50/60Hz	max 3	18 LED		[°]	180cm	0,1	IP 20			F	1/6/24	330 [g]	

EBOS LED12/JC

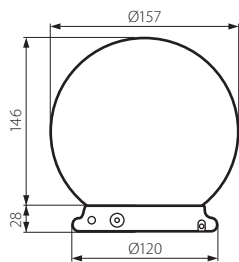

■ EBOS LED 12/JC

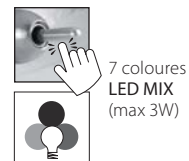
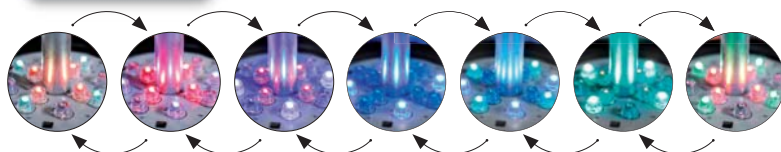
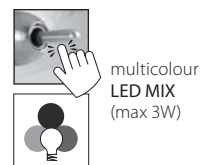
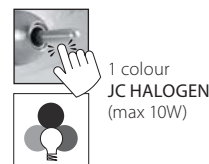

- teleso svetidla: plast a ocelový plech / difúzor: mliečne sklo / těleso transformátoru: plast
- svetidlo obsahuje LED diódy, díky čomu máme možnost získat 7 farieb svetla, a halogénovú žiarovku typu JC
- svetidlo obsahuje transformátor LED, ktorý je priamo napojen na prívod svetidla

NEW	<b>Kanlux</b>	<b>Kanlux</b>	EAN 5905339076007	biela	[W] (LED) max3 / (JC) max10	DKC SK bez DPH 29,37 €							
	EBOS LED12/JC	07600											
220-240V~	12 LED				[°]	200cm	IP 20			F	1/-/4	970 [g]	

# KREON TL-GX53

**Kanlux**

Nábytkové žiarivkové svetidlo

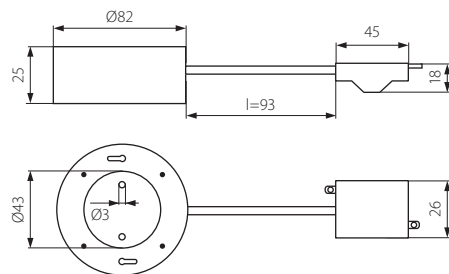

■ KREON TL-GX53



■ teleso svetidla: ocelový plech

NEW	<b>Kanlux</b>		EAN 		DKC SK bez DPH
	KREON TL-GX53	07440	5905339074409	matný chróm	13,21 €

# FAUST

Dekoračné svetidlo

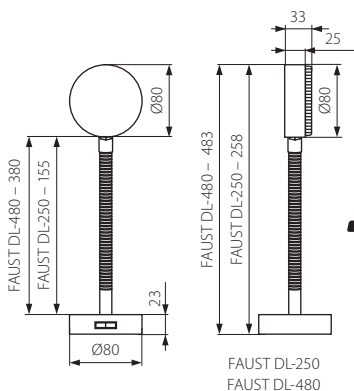

■ FAUST DL-260



■ FAUST KT-455

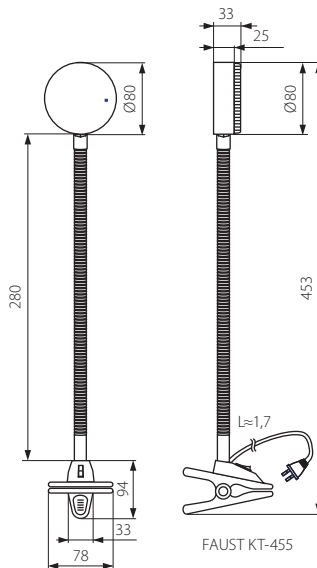

■ FAUST DL-480



■ těleso svetidla: ocelový plech

■ model FAUST KT-455 montáž pomocou svorky

NEW	<b>Kanlux</b>		EAN 			[g]	DKC SK bez DPH
	FAUST DL-260	07421	5905339074218	matný chróm	svorkovnica 1 - 2,5 mm <sup>2</sup>	342	21,62 €
NEW	FAUST DL-480	07422	5905339074225	matný chróm	svorkovnica 1 - 2,5 mm <sup>2</sup>	420	21,02 €
NEW	FAUST KT-455	07420	5905339074201	matný chróm	vidlica 170cm, 2 x 0,75mm <sup>2</sup>	422	21,62 €

Nábytkové bodové svetidlo

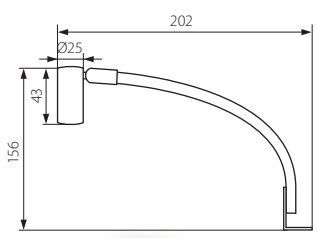

44-48, 90-91



392-397



■ SALUT DL-305-S-C/M



■ SALUT DL-305-S-C



■ SALUT DL-305-S-BR/M

■ teleso a rameno svetidla: kovová zliatina

■ ako zdroj svetla tiež možno použiť žiarovku MR-11

<b>Kanlux</b>		EAN 		DKC SK bez DPH
SALUT DL-305-S-BR/M	00944	5905339009449	matná mosadz	8,43 €
SALUT DL-305-S-C	00942	5905339009425	chróm	7,73 €
SALUT DL-305-S-C/M	00943	5905339009432	matný chróm	8,43 €

12V max 50 MR-16 Gx5,3 90 60 2x0,5mm<sup>2</sup> 10 cm 0,5 IP 20 1-/50 210 CE

Nábytkové bodové svetidlo

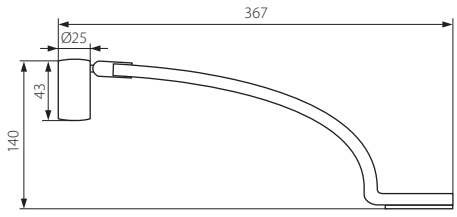

44-48, 90-91



392-397



■ SALUT DL-307-S-C



■ SALUT DL-307-S-BR/M



■ SALUT DL-307-S-C/M



■ teleso a rameno svetidla: kovová zliatina

■ ako zdroj svetla tiež možno použiť žiarovku MR-11

<b>Kanlux</b>		EAN 		DKC SK bez DPH
SALUT DL-307-S-BR/M	00949	5905339009494	matná mosadz	8,43 €
SALUT DL-307-S-C	00947	5905339009470	chróm	7,73 €
SALUT DL-307-S-C/M	00948	5905339009487	matný chróm	8,43 €

12V max 50 MR-16 Gx5,3 90 60 2x0,5mm<sup>2</sup> 10 cm 0,5 IP 20 1-/50 270 CE

# SALUT DL-138RA/1

**Kanlux**

Nábytkové bodové svetidlo



44-48,  
90-91



392-397



■ SALUT DL-138RA/1-C



■ SALUT DL-138RA/1-C/M

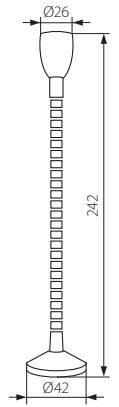

- teleso a rameno svetidla: kovová zliatina
- ohybné rameno
- ako zdroj svetla tiež možno použiť žiarovku MR-11

<b>Kanlux</b>		EAN 		DKC SK bez DPH
SALUT DL-138RA/1-C	00933	5905339009333	chróm	8,53 €
SALUT DL-138RA/1-C/M	00932	5905339009326	matný chróm	8,53 €

12V		MR-16	Gx5,3			2x0,5mm <sup>2</sup>	10 cm		IP 20					1/-/100		210 [g]	
-----	--	-------	-------	--	--	----------------------	-------	--	-------	--	--	--	--	---------	--	---------	--

# ZEPO LFD-T02

Nábytkové žiarivkové svetidlo



■ ZEPO LFD-T02-C/M



■ ZEPO LFD-T02/S-C/M



■ ZEPO LFD-T02-C



■ ZEPO LFD-T02/S-C

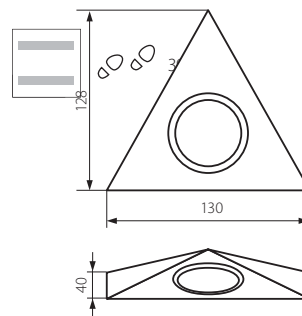

ZEPO LFD-T02

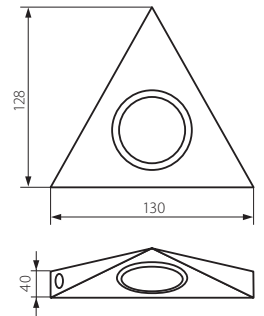

ZEPO LFD-T02/S

- teleso svetidla: ocelový plech / difuzor: sklo
- svetidlá ZEPO LFD-T02/S-C, ZEPO LFD-T02/S-C/M, ZEPO LFD-T02/S-MPC s vypínačom

<b>Kanlux</b>		EAN 		DKC SK bez DPH
ZEPO LFD-T02-C	04380	5905339043801	chróm	4,48 €
ZEPO LFD-T02-C/M	04381	5905339043818	matný chróm	4,48 €
ZEPO LFD-T02/S-C	04385	5905339043856	chróm	5,78 €
ZEPO LFD-T02/S-C/M	04386	5905339043863	matný chróm	5,78 €
ZEPO LFD-T02/S-BR/M	04389	5905339043894	matná mosadz	5,78 €

12V		JC	G4			2x0,5mm <sup>2</sup>	10 cm		IP 20					1/-/50		186 [g]	
-----	--	----	----	--	--	----------------------	-------	--	-------	--	--	--	--	--------	--	---------	--

Sada troch lineárnych LED modulov

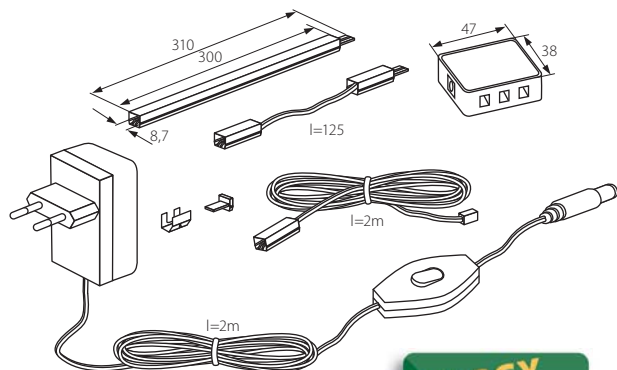

LINEAL 3LED12



teleso: plast

		EAN 			DKC SK bez DPH								
LINEAL 3LED12	07120	5905339071200	biela	teplá biela	29,71 €								

- možnosť sériového spájania LED modulov do tzv. 'lineárnych svetelných línií' pomocou krátkych spojovacích vodičov
- možnosť paralelného spájania LED modulov pomocou dlhých spojovacích vodičov
- sietový adaptér s vypínačom (1ks), napájací rozvádzač (1ks), spojovacie vodiče krátke 12,5 cm (2ks), spojovacie vodiče dlhé 2 m (3ks), koncové záslepky LED modulov (3ks), úchytka, držáky a komplet príslušenstva pre montáž

## TETRIS LED

Sada lineárnych modulov LED

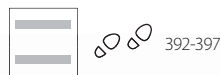
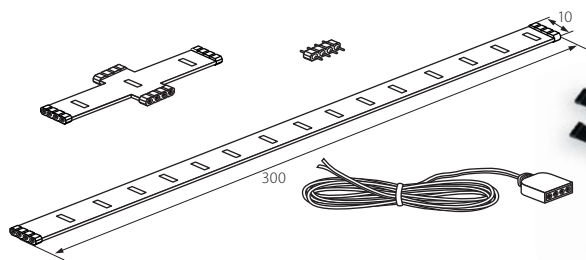

TETRIS 2LED15

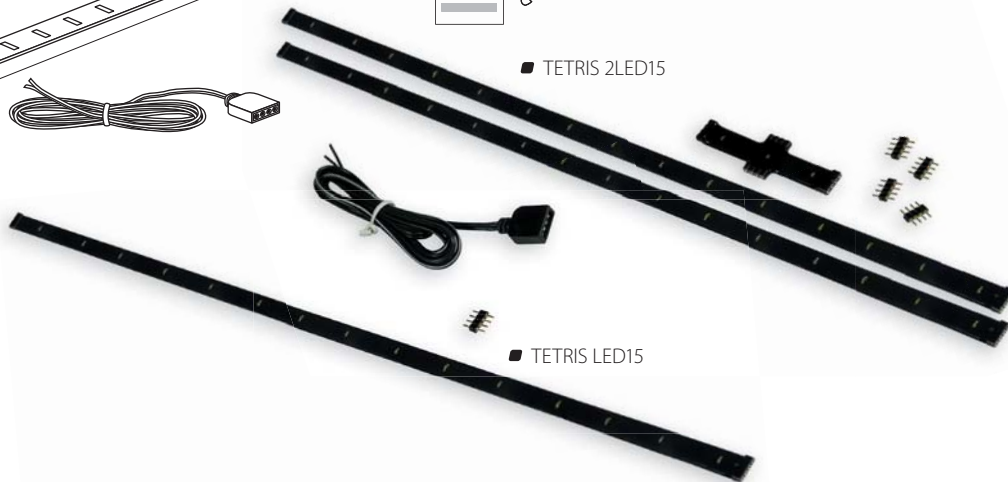

TETRIS LED15

teleso: plast

		EAN 					DKC SK bez DPH	
TETRIS LED15	07241	5905339072412	čierna	15 LED	chladno biela	8	9,87 €	
TETRIS 2LED15	07240	5905339072405	čierna	2 x 15 LED	chladno biela	28	20,75 €	

- možnosť sériového spájania modulov LED do tzv. „svetelnej línie“
- napájacie zariadenie pre spojenie s modulmi nie je súčasťou dodávky
- sada TETRIS 2LED15 obsahuje: modul LED (2ks), spojnice (4ks), rozbočka LED (1ks), prípojka (1ks), sada TETRIS LED15 obsahuje: modul LED (1ks), spojnice (1ks)

# VOLCANO LED

**Kanlux**

Lineárne LED moduly

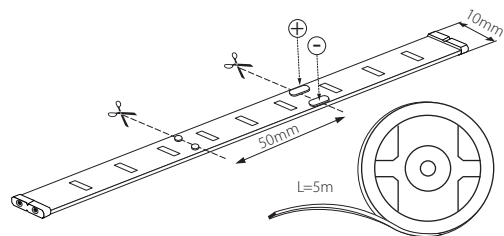
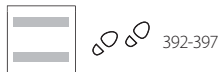

L = 5m (100 x 50mm) = 300 LED  
s = 50mm = 3 LED / 20mA

■ VOLCANO LED-WW 5M

■ teleso: plast



	Kanlux	EAN		Tc [K]	DKC SK bez DPH
<b>NEW</b> VOLCANO LED-WW 5M	07295	5905339072955	teplá biela	2700-3200	100,00 €
<b>NEW</b> VOLCANO LED-CW 5M	07294	5905339072948	studená biela	5000-6500	100,00 €
<b>NEW</b> VOLCANO LED-Y 5M	07293	5905339072931	žltá	-	100,00 €
<b>NEW</b> VOLCANO LED-OR 5M	07296	5905339072962	oranžová	-	100,00 €
<b>NEW</b> VOLCANO LED-GN 5M	07292	5905339072924	zelená	-	100,00 €
<b>NEW</b> VOLCANO LED-BL 5M	07290	5905339072900	modrá	-	100,00 €
<b>NEW</b> VOLCANO LED-RE 5M	07291	5905339072917	červená	-	100,00 €

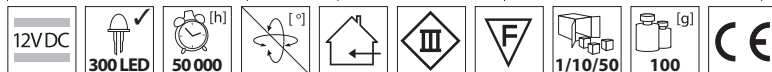

- cena za pasek o dĺžke 5m
- možnosť delenia LED pásov na segmenty (50mm = 3xLED)
- pre správnu funkciu je nutný elektronický napájač LED, napr. ADI 65, RICO LED, TRETO LED dostupný v ponuke Kanlux

# ISTRO LED

Lineárne LED moduly

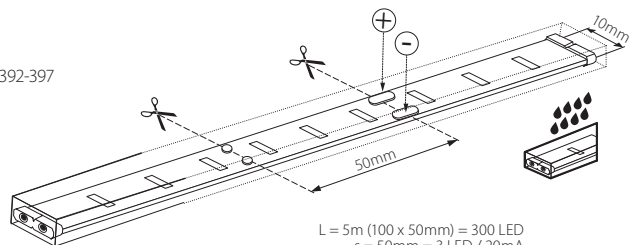
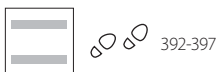

L = 5m (100 x 50mm) = 300 LED  
s = 50mm = 3 LED / 20mA

■ ISTRO LED-Y 5M

■ teleso: plast



	Kanlux	EAN		Tc [K]	DKC SK bez DPH
<b>NEW</b> ISTRO LED-WW 5M	07755	5905339077554	teplá biela	2700-3200	105,13 €
<b>NEW</b> ISTRO LED-CW 5M	07751	5905339077516	studená biela	5000-6500	105,13 €
<b>NEW</b> ISTRO LED-Y 5M	07756	5905339077561	žltá	-	105,13 €
<b>NEW</b> ISTRO LED-OR 5M	07753	5905339077530	oranžová	-	105,13 €
<b>NEW</b> ISTRO LED-GN 5M	07752	5905339077523	zelená	-	105,13 €
<b>NEW</b> ISTRO LED-BL 5M	07750	5905339077509	modrá	-	105,13 €
<b>NEW</b> ISTRO LED-RE 5M	07754	5905339077547	červená	-	105,13 €



- cena za pasek o dĺžke 5m
- možnosť delenia LED pásov na segmenty (50mm = 3xLED)
- pre správnu funkciu je nutný elektronický napájač LED, napr. ADI 65, RICO LED, TRETO LED dostupný v ponuke Kanlux
- produkt má vysoký stupeň krytia IP65, kvôli čeho je prachotesný a vodeodolný

Nábytkové žiarivkové svetidlo

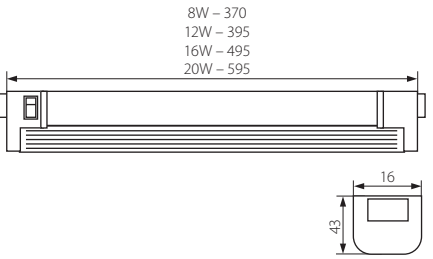

■ GRELA TL2004B-8W



■ GRELA TL2004B-12W



■ GRELA TL2004B-16W



■ GRELA TL2004B-20W

■ teleso svetidla a difuzor: plast / rám svetidla: kov

Kanlux	Kanlux	EAN	Farba	[W]	[g]	DKC SK bez DPH
GRELA TL2004B-8W	00520	5905339005205	biela	8	260	10,09 €
GRELA TL2004B-12W	00521	5905339005212	biela	12	270	10,49 €
GRELA TL2004B-16W	00522	5905339005229	biela	16	310	11,25 €
GRELA TL2004B-20W	00523	5905339005236	biela	20	340	13,05 €

230V~	EVG BALLAST	T4	G5	Tc [K] 4000	Opt	175 cm	0,3 [m]	IP 20	1/12/24	CE
-------	-------------	----	----	-------------	-----	--------	---------	-------	---------	----

■ možnosť priebežného propojenia až 10 svetidiel

Nábytkové žiarivkové svetidlo

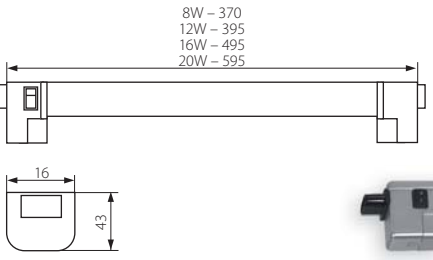

■ GRELA TL2004C-8W-SR



■ GRELA TL2004C-12W-SR



■ GRELA TL2004C-16W-SR



■ GRELA TL2004C-20W-SR

■ teleso: plast / základna: oceľ

	Kanlux	Kanlux	EAN	Farba	[W]	[g]	DKC SK bez DPH
NEW	GRELA TL2004C-8W-SR	00530	5905339005304	strieborná	8	260	10,09 €
NEW	GRELA TL2004C-12W-SR	00531	5905339005311	strieborná	12	270	10,49 €
NEW	GRELA TL2004C-16W-SR	00532	5905339005328	strieborná	16	300	11,25 €
NEW	GRELA TL2004C-20W-SR	00533	5905339005335	strieborná	20	330	13,05 €

230V~	EVG BALLAST	T4	G5	Tc [K] 4000	Opt	175 cm	0,3 [m]	IP 20	1/12/24	CE
-------	-------------	----	----	-------------	-----	--------	---------	-------	---------	----

■ možnosť priebežného propojenia až 10 svetidiel

Nábytkové žiarivkové svetidlo

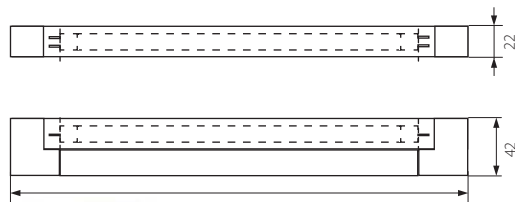

■ MERA TL-8



■ MERA TL-13



8W - 343  
13W - 573  
21W - 900

■ MERA TL-21



■ teleso svetidla a difuzor: plast

Kanlux	Kanlux	EAN		[W]		[g]	DKC SK bez DPH
MERA TL-8	04730	5905339047304	biela	8	30	250	8,80 €
MERA TL-13	04731	5905339047311	biela	13	30	340	10,12 €
MERA TL-21	04732	5905339047328	biela	21	20	470	14,07 €

  

230V~	EVG BALLAST	T5	G5	Tc [K] 4000	Opt	2x0,75mm <sup>2</sup> 175 cm	0,3	IP 20							
-------	-------------	----	----	-------------	-----	------------------------------	-----	-------	--	--	--	--	--	--	--

■ možnosť priebežného zapojenia svetidiel pomocou prepojovacej šnúry MERA PP, až 18 svetidiel MERA TL-8, alebo 11 svetidiel MERA TL13, alebo 8 svetidiel MERA TL-21  
 ■ opáľový, prizmatický difuzor

# GLORIA TL3011

Nábytkové žiarivkové svetidlo

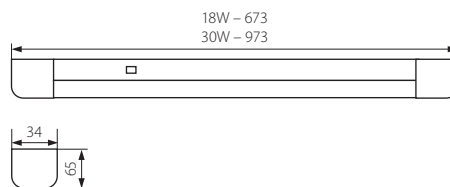

■ GLORIA TL3011-30W



■ GLORIA TL3011-18W



■ teleso svetidla a difuzor: plast / rám svetidla: kov

Kanlux	Kanlux	EAN		[W]		[g]	DKC SK bez DPH
GLORIA TL3011-18W	00510	5905339005106	biela	18	20	675	12,91 €
GLORIA TL3011-30W	00511	5905339005113	biela	30	12	1 041	18,39 €

230V~	EVG BALLAST	T8	G13	Tc [K] 4000	Opt	3 x 2,5	0,3	IP 20							
-------	-------------	----	-----	-------------	-----	---------	-----	-------	--	--	--	--	--	--	--





# CELT TL2050-13W-SR



Nábytkové žiarivkové svetidlo

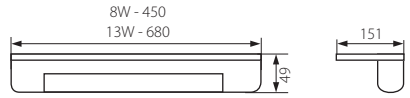

■ CELT TL2050-13W-SR

■ teleso svetidla a difúzor: plast / sklenená polica

		EAN 		DKC SK bez DPH
CELT TL2050-13W-SR	04872	5905339048721	strieborná	33,49 €

# EVAN TL

Nábytkové žiarivkové svetidlo



■ EVAN TL-8



■ EVAN TL-13

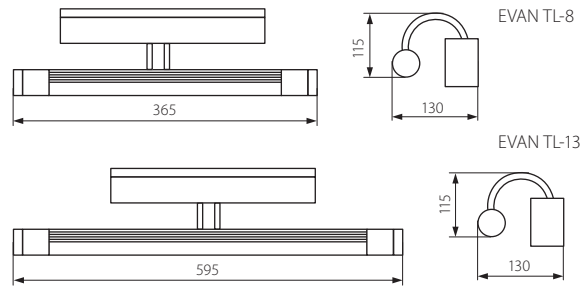

■ teleso: zliatina hliníka / difúzor: plast

		EAN 				DKC SK bez DPH
EVAN TL-8	00535	5905309005358	strieborná	8	510	23,83 €
EVAN TL-13	00536	5905309005365	strieborná	13	610	27,72 €

--	--	--	--	--	--	--	--	--

■ bez vypínača

Dekoračné svetidlo LED

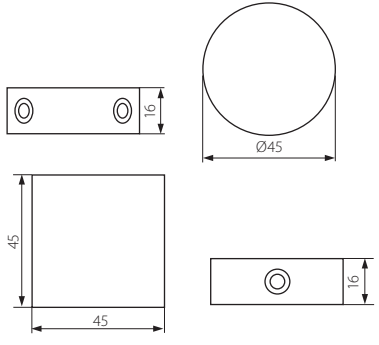

■ MIG LED-40



■ MIG LED-4L

■ teleso svetidla: hliníková zliatina

		EAN 				DKC SK bez DPH
MIG LED-40	04790	5905339047908	matný nikel	biela	35	9,86 €
MIG LED-4L	04791	5905339047915	matný nikel	biela	50	9,86 €

12VDC | 0,24 | 4 LED | 4000 | 2x0,5mm<sup>2</sup> | 15 cm | IP 20 | 1/10/100 | CE

■ nevýmenný zdroj svetla

## ZENA EL

Nástenné svetidlo pevné

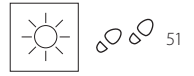
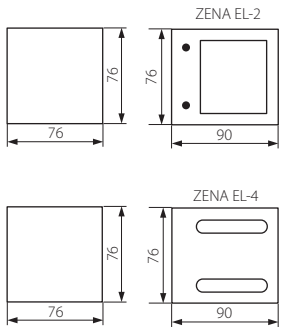

■ ZENA EL-2



■ ZENA EL-4

■ teleso: lakovaný výlisok z oceleového plechu / mliečne sklíčka

		EAN 			DKC SK bez DPH
ZENA EL-2	07231	5905339072313	saténový chróm	272	10,41 €
ZENA EL-4	07230	5905339072306	saténový chróm	238	8,76 €

230V~ | max 40 | G9 | G9 | IP 20 | 3 x 2,5 | 1/50 | CE

# VANTI EL-I440



**Kanlux**

Nástenné svietidlo pevné



44-48,  
90-91

■ VANTI EL-I440

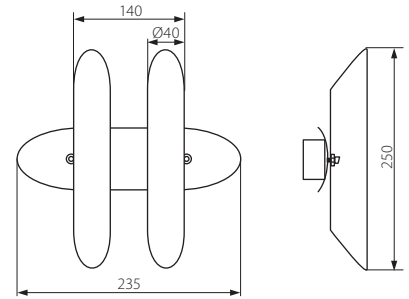

■ teleso: lakovaný výlisok z oceleového plechu

**Kanlux**

**Kanlux**

EAN



5905339072351



saténový chróm

DKC SK  
bez DPH

21,00 €

NEW

VANTI EL-I440

07235



# LEVEL EL-150L



Nástenné svietidlo pevné



44-48,  
90-91

■ LEVEL EL-150L

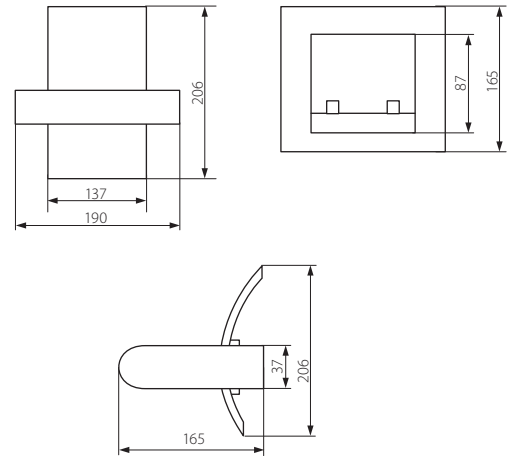

■ teleso: lakovaný výlisok z oceleového plechu / sklenené tienidlo lampy

**Kanlux**

**Kanlux**

EAN



5905339072368



saténový chróm

DKC SK  
bez DPH

21,22 €

LEVEL EL-150L

07236



Svietidlo prisadené

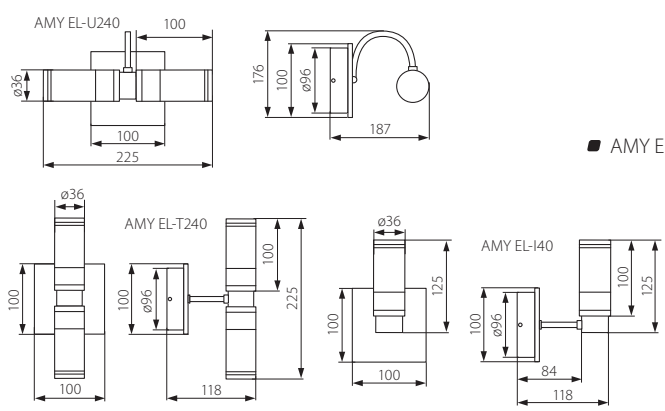

■ AMY EL-I40



■ AMY EL-U240



■ AMY EL-T240

■ základňa: oceľový plech / rameno: oceľová rúrka / tienidlo: sklo

Kanlux	Kanlux	EAN		[W]	[g]	DKC SK bez DPH
AMY EL-I40	07130	5905339071309	saténový chróm	max 40	380	17,73 €
AMY EL-T240	07131	5905339071316	saténový chróm	2 x max 40	455	26,62 €
AMY EL-U240	07132	5905339071323	saténový chróm	2 x max 40	525	29,77 €

- vyšší stupeň krytia
- určené k montáži do priestorov so zvýšenou vlhkosťou, napr. kúpeľní

## TOMA EL

Halogenové svietidlo prisadené

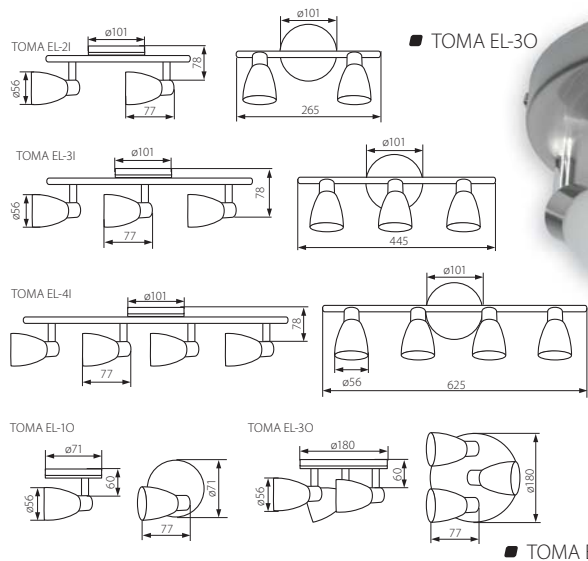

■ TOMA EL-30



■ TOMA EL-10

■ TOMA EL-21

■ TOMA EL-31

■ TOMA EL-41

■ teleso svietidla: oceľový plech / difuzory: sklo

Kanlux	Kanlux	EAN		[W]	[g]	DKC SK bez DPH	
TOMA EL-10	01020	5905339010209	saténový chróm	max 40	1-/48	200	7,67 €
TOMA EL-21	01021	5905339010216	saténový chróm	2 x max 40	1-/24	460	18,36 €
TOMA EL-31	01022	5905339010223	saténový chróm	3 x max 40	1-/20	660	28,41 €
TOMA EL-30	01023	5905339010230	saténový chróm	3 x max 40	1-/24	670	22,64 €
TOMA EL-41	01024	5905339010247	saténový chróm	4 x max 40	1-/12	825	36,81 €

Halogénové svietidlo prisadené

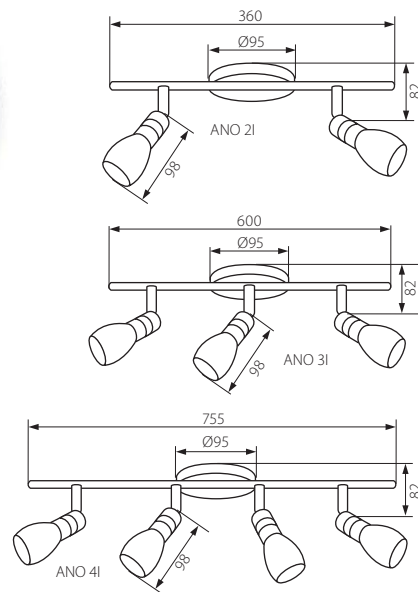

teleso svietidla: ocelový plech / difuzory: sklo

Kanlux	Kanlux	EAN		[W]	[g]	DKC SK bez DPH
ANO 10	04720	5905339047205		max 40	200	8,50 €
ANO 21	04721	5905339047212		2 x max 40	480	19,22 €
ANO 31	04722	5905339047229		3 x max 40	670	29,01 €
ANO 41	04723	5905339047236		4 x max 40	890	37,34 €

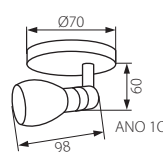

230V~ G9 G9 320 90 3 x 2,5 0,5 IP 20

Halogénové svietidlo prisadené

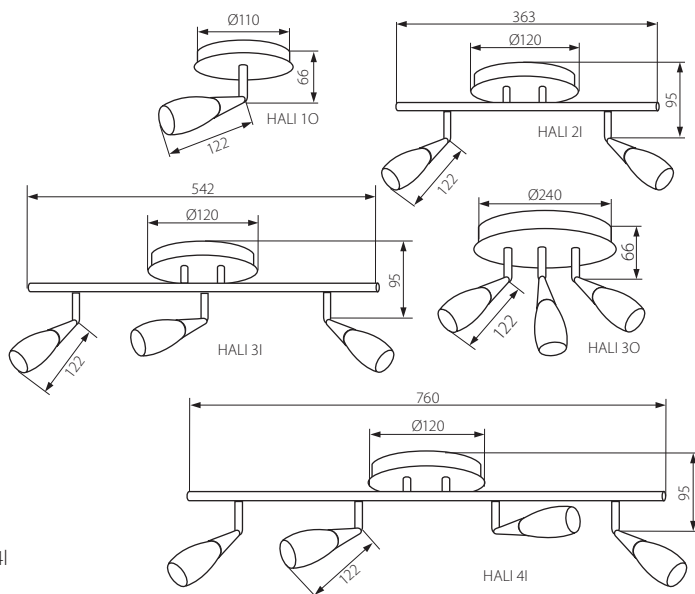
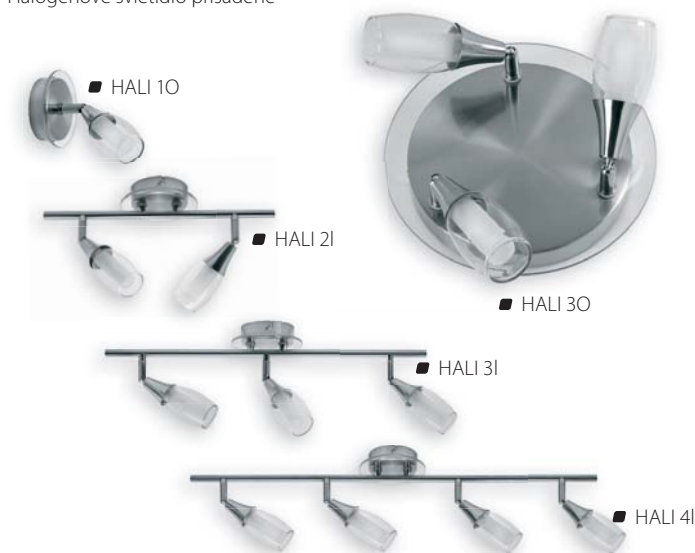

teleso svietidla: ocelový plech / difuzory: sklo

Kanlux	Kanlux	EAN		[W]	[g]	DKC SK bez DPH
HALI 10	04725	5905339047250		max 40	290	8,50 €
HALI 21	04726	5905339047267		2 x max 40	560	19,22 €
HALI 31	04727	5905339047274		3 x max 40	730	29,01 €
HALI 30	04729	5905339047298		3 x max 40	1 030	30,94 €
HALI 41	04728	5905339047281		4 x max 40	930	37,34 €

230V~ G9 G9 320 90 3 x 2,5 0,5 IP 20

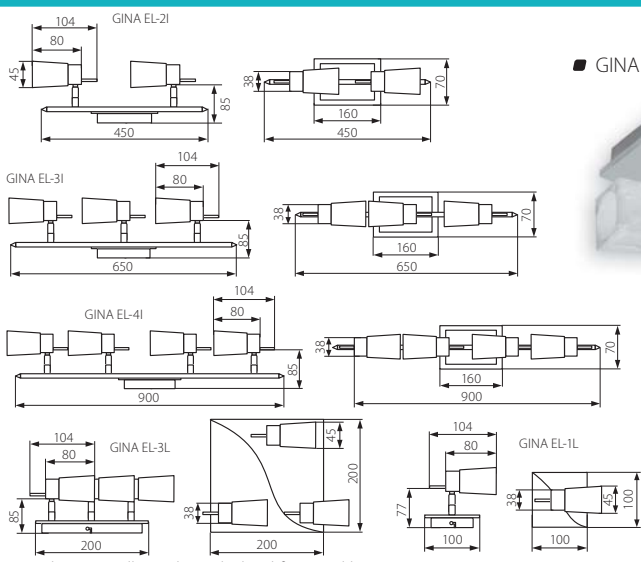

GINA EL-3L

Halogénové svietidlo prisadené



teleso svietidla: ocelový plech / difuzory: sklo

Kanlux	Kanlux	EAN	
GINA EL-1L	07110	5905339071101	saténový chróm
GINA EL-2I	07111	5905339071118	saténový chróm
GINA EL-3I	07112	5905339071125	saténový chróm
GINA EL-3L	07113	5905339071132	saténový chróm
GINA EL-4I	07114	5905339071149	saténový chróm



[W]		[g]	DKC SK bez DPH
max 40	1/-/36	510	10,19 €
2 x max 40	1/-/12	860	20,71 €
3 x max 40	1/-/12	1 150	28,05 €
3 x max 40	1/-/12	1 680	28,05 €
4 x max 40	1/-/6	1 480	36,78 €

230V~ G9 G9 320 90 3 x 2,5 0,5 IP 20

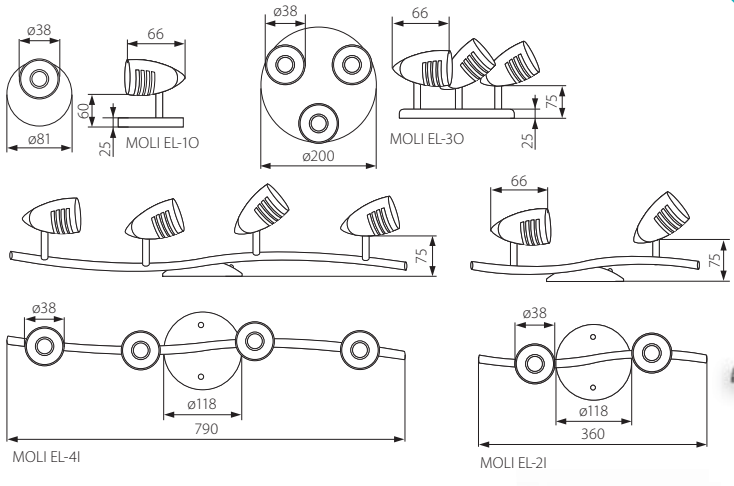

Halogénové svietidlo prisadené



svietidlo: ocelový výlisok

Kanlux	Kanlux	EAN	
MOLI EL-10	07085	5905339070852	saténový chróm
MOLI EL-2I	07086	5905339070869	saténový chróm
MOLI EL-30	07087	5905339070876	saténový chróm
MOLI EL-4I	07088	5905339070883	saténový chróm



[W]		[g]	DKC SK bez DPH
max 50	1/-/20	170	6,21 €
2 x max 50	1/-/8	370	13,54 €
3 x max 50	1/-/8	520	17,66 €
4 x max 50	1/-/4	660	24,63 €

230V~ JDR GU10 320 90 3 x 2,5 0,5 IP 20

# SONDA EL

**Kanlux**

Svietidlo prisadené

■ SONDA EL-1L

■ SONDA EL-4L



■ SONDA EL-3J

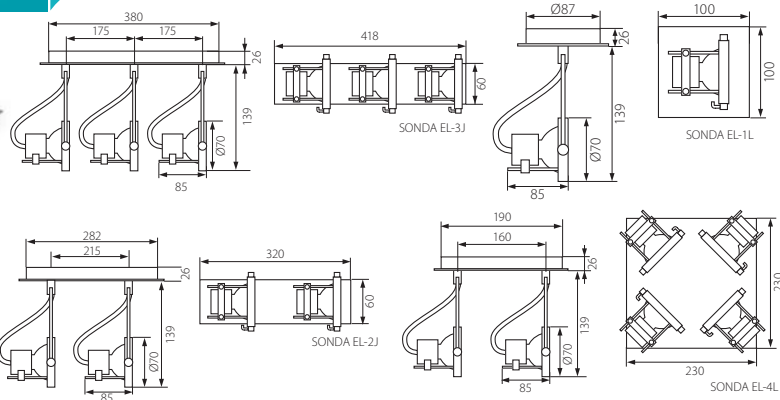

■ SONDA EL-2J

■ teleso svietidla a reflektory: ocelový plech

Kanlux	Kanlux	EAN		[W]	[g]	DKC SK bez DPH	
SONDA EL-1L	04795	5905339047953	saténový chróm	max 50	1/-/24	490	12,31 €
SONDA EL-2J	04796	5905339047960	saténový chróm	2 x max 50	1/-/12	930	26,46 €
SONDA EL-3J	04797	5905339047977	saténový chróm	3 x max 50	1/-/6	1 415	36,15 €
SONDA EL-4L	04798	5905339047984	saténový chróm	4 x max 50	1/-/8	1 940	44,11 €

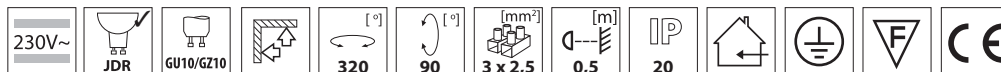

# ARDEA

Plafón

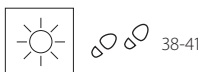

■ ARDEA 1030 S/ML-BI

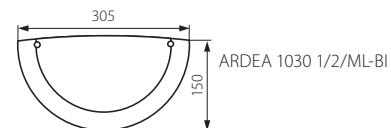

ARDEA 1030 1/2/ML-BI



■ ARDEA 1130 D/ML-BI

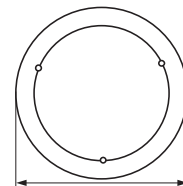

ARDEA 1030 M/ML-BI  
ARDEA 1030 S/ML-BI  
ARDEA 1130 D/ML-BI

ARDEA 1030 M/ML-BI – Ø270  
ARDEA 1030 S/ML-BI – Ø305  
ARDEA 1130 D/ML-BI – Ø385



■ ARDEA 1030 1/2/ML-BI



■ ARDEA 1030 M/ML-BI

■ tienidlo: ohýbané sklo, zvnútra farebné / teleso svietidla a lem: galvanizovaný ocelový plech príchytky tienidla: mosadz

Kanlux	Kanlux	EAN		[W]	[g]	DKC SK bez DPH
ARDEA 1030 1/2/ML-BI	70788	5905339707888	biela	max 60	600	5,41 €
ARDEA 1030 M/ML-BI	70786	5905339707864	biela	max 60	800	5,46 €
ARDEA 1030 S/ML-BI	70784	5905339707840	biela	max 60	1 000	5,84 €
ARDEA 1130 D/ML-BI	70782	5905339707826	biela	2 x max 60	1 400	10,12 €

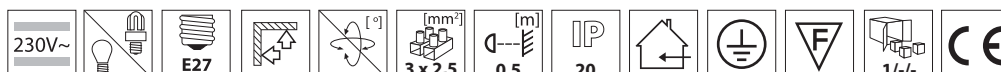

■ povrch tienidla rovnomerne šíri svetlo



Plafón

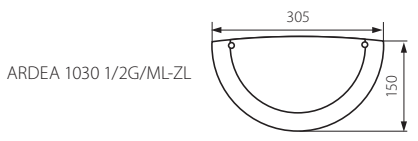

ARDEA 1030 1/2G/ML-ZL

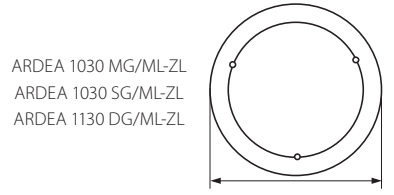
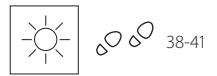

ARDEA 1030 MG/ML-ZL  
ARDEA 1030 SG/ML-ZL  
ARDEA 1130 DG/ML-ZL

ARDEA 1030 MG/ML-ZL - Ø260  
ARDEA 1030 SG/ML-ZL - Ø310  
ARDEA 1130 DG/ML-ZL - Ø375



■ ARDEA 1030 1/2G/ML-SR



■ ARDEA 1030 SG/ML-SR



■ ARDEA 1130 DG/ML-SR



■ ARDEA 1030 MG/ML-SR

■ tienidlo: ohýbané sklo, zvnútra farebné / teleso svietidla a lem: galvanizovaný ocelový plech príchytky tienidla: mosadz

Kanlux	Kanlux	EAN		[W]	[g]	DKC SK bez DPH
ARDEA 1030 1/2G/ML-SR	70771	5905339707710	stříborná	max 60	400	10,22 €
ARDEA 1030 MG/ML-SR	70766	5905339707666	stříborná	max 60	600	10,95 €
ARDEA 1030 SG/ML-SR	70761	5905339707611	stříborná	max 60	800	11,72 €
ARDEA 1130 DG/ML-SR	70756	5905339707567	stříborná	2 x max 60	1 200	20,25 €

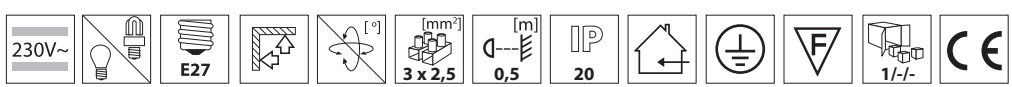

■ povrch tienidla rovnomerne šíri svetlo

## TIVA

Plafón

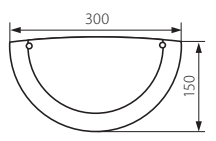

TIVA 1030 1/2DR/ML-SN

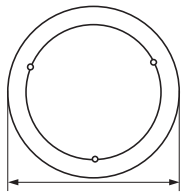
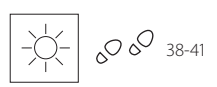

TIVA 1030 MDR/ML-SN - Ø260  
TIVA 1030 SDR/ML-SN - Ø300  
TIVA 1130 DDR/ML-SN - Ø385



■ TIVA 1130 DDR/ML-SN



■ TIVA 1030 SDR/ML-SN



■ TIVA 1030 1/2DR/ML-SN



■ TIVA 1030 MDR/ML-SN

■ tienidlo: ohýbané sklo, zvnútra farebné / teleso svietidla: ocelový plech / lem: drevo príchytky tienidla: mosadz

Kanlux	Kanlux	EAN		[W]	[g]	DKC SK bez DPH
TIVA 1030 1/2DR/ML-SN	70740	5905339707406	borovica	max 60	600	7,77 €
TIVA 1030 MDR/ML-SN	70730	5905339707307	borovica	max 60	800	9,49 €
TIVA 1030 SDR/ML-SN	70720	5905339707208	borovica	max 60	1 000	10,79 €
TIVA 1130 DDR/ML-SN	70710	5905339707109	borovica	2 x max 60	1 600	16,40 €

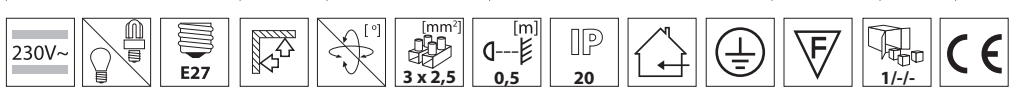

■ povrch tienidla rovnomerne šíri svetlo

Plafón



■ TIVA 1130 DDR/ML-DB

■ TIVA 1030 1/2DR/ML-DB

■ TIVA 1030 SDR/ML-DB

■ TIVA 1030 MDR/ML-DB

■ tienidlo: ohýbané sklo, zvnútra farebné / teleso svietidla: ocelový plech / lem: drevo príchytky tienidla: mosadz

Kanlux	Kanlux	EAN		[W]	[g]	DKC SK bez DPH
TIVA 1030 1/2DR/ML-DB	70741	5905339707413	dub	max 60	600	7,77 €
TIVA 1030 MDR/ML-DB	70731	5905339707314	dub	max 60	800	9,49 €
TIVA 1030 SDR/ML-DB	70721	5905339707215	dub	max 60	1 000	10,79 €
TIVA 1130 DDR/ML-DB	70711	5905339707116	dub	2 x max 60	1 600	16,40 €

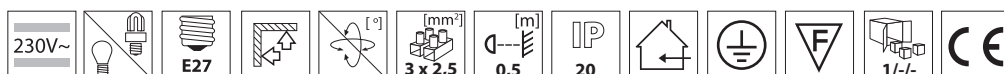

■ povrch tienidla rovnomerne šíri svetlo

Plafón



■ TIVA 1130 DDR/ML-MH

■ TIVA 1030 1/2DR/ML-MH

■ TIVA 1030 SDR/ML-MH

■ TIVA 1030 MDR/ML-MH

■ tienidlo: ohýbané sklo, zvnútra farebné / teleso svietidla: ocelový plech / lem: drevo príchytky tienidla: mosadz

Kanlux	Kanlux	EAN		[W]	[g]	DKC SK bez DPH
TIVA 1030 1/2DR/ML-MH	70742	5905339707420	mahagón	max 60	600	7,77 €
TIVA 1030 MDR/ML-MH	70732	5905339707321	mahagón	max 60	800	9,49 €
TIVA 1030 SDR/ML-MH	70722	5905339707222	mahagón	max 60	1 000	10,79 €
TIVA 1130 DDR/ML-MH	70712	5905339707123	mahagón	2 x max 60	1 600	16,40 €

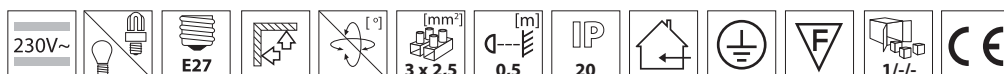

■ povrch tienidla rovnomerne šíri svetlo

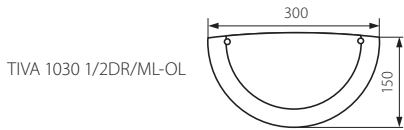

TIVA 1030 1/2DR/ML-OL



38-41

■ TIVA 1030 SDR/ML-OL

TIVA 1030 MDR/ML-OL  
TIVA 1030 SDR/ML-OL  
TIVA 1130 DDR/ML-OL

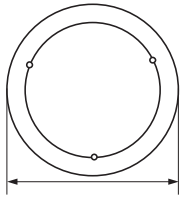

TIVA 1030 MDR/ML-OL – Ø260  
TIVA 1030 SDR/ML-OL – Ø300  
TIVA 1130 DDR/ML-OL – Ø385

■ TIVA 1030 MDR/ML-OL



■ TIVA 1130 DDR/ML-OL



■ TIVA 1030 1/2DR/ML-OL

■ tienidlo: ohýbané sklo, zvnútra farebné / teleso svetidla: ocelový plech / lem: drevo príchytky tienidla: mosadz

Kanlux	Kanlux	EAN		[W]	[g]	DKC SK bez DPH
TIVA 1030 1/2DR/ML-OL	70747	5905339707475	jeľša	max 60	600	7,77 €
TIVA 1030 MDR/ML-OL	70737	5905339707376	jeľša	max 60	800	9,49 €
TIVA 1030 SDR/ML-OL	70727	5905339707277	jeľša	max 60	1 000	10,79 €
TIVA 1130 DDR/ML-OL	70717	5905339707178	jeľša	2 x max 60	1 600	16,40 €

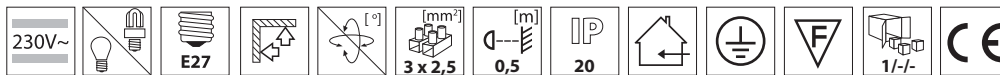

■ povrch tienidla rovnomerne šíri svetlo

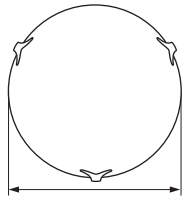

SYLENI 1030 MY/ML-SR – Ø300  
SYLENI 1130 SY/ML-SR – Ø400



38-41

■ SYLENI 1130 SY/ML-SR



■ SYLENI 1030 MY/ML-SR

■ tienidlo: ohýbané sklo, zvnútra farebné, pieskované z vonkajšej strany / teleso svetidla: ocelový plech / príchytky tienidla: galvanizovaná zliatina hliníku

Kanlux	Kanlux	EAN		[W]	[g]	DKC SK bez DPH
SYLENI 1030 MY/ML-SR	70795	5905339707956	strieborná	max 60	1 000	16,83 €
SYLENI 1130 SY/ML-SR	70793	5905339707932	strieborná	2 x max 60	1 600	25,46 €

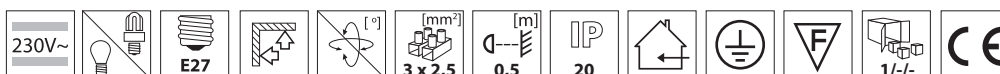

■ povrch tienidla rovnomerne šíri svetlo

# VERA LED EL

**Kanlux**

Zahradné svietidlo LED

■ VERA LED EL-22I-UP



■ VERA LED EL-18L-UP



■ VERA LED EL-85



■ VERA LED EL-50



■ VERA LED EL-30

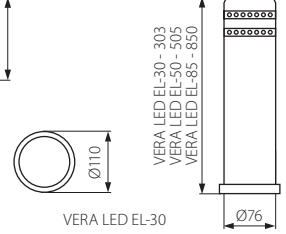
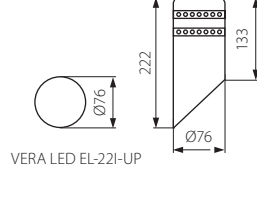
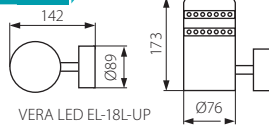

VERA LED EL-30  
VERA LED EL-50  
VERA LED EL-85



■ teleso svietidla: ocelový plech / ozdobný piersteneč: plast

	<b>Kanlux</b>	EAN			[g]	DKC SK bez DPH
NEW	VERA LED EL-18L-UP	07470	5905339074706	matný chróm	450	20,69 €
NEW	VERA LED EL-22I-UP	07471	5905339074713	matný chróm	340	20,69 €
NEW	VERA LED EL-30	07472	5905339074720	matný chróm	530	22,57 €
NEW	VERA LED EL-50	07473	5905339074737	matný chróm	725	24,58 €
NEW	VERA LED EL-85	07474	5905339074744	matný chróm	1065	28,59 €

220-240V~ 50Hz max 2 2x12LED 4400 Tc [K] [°] [mm²] 3x1-2,5 IP 44 F 1-/12 CE

# SORIN LED EL

Zahradné svietidlo LED

■ SORIN LED EL-70



■ SORIN LED EL-40



■ SORIN LED EL-32I-UP

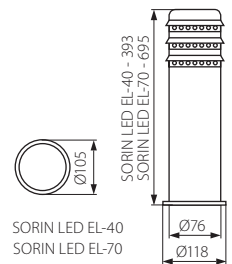
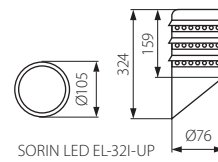
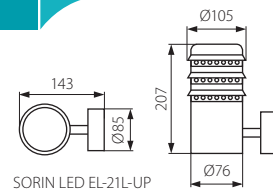

SORIN LED EL-40  
SORIN LED EL-70



■ teleso svietidla: ocelový plech / ozdobný piersteneč: plast

	<b>Kanlux</b>	EAN			[g]	DKC SK bez DPH
NEW	SORIN LED EL-21L-UP	07500	5905339075000	matný chróm	610	24,49 €
NEW	SORIN LED EL-32I-UP	07501	5905339075017	matný chróm	520	26,01 €
NEW	SORIN LED EL-40	07502	5905339075024	matný chróm	785	28,24 €
NEW	SORIN LED EL-70	07503	5905339075031	matný chróm	1065	31,27 €

220-240V~ 50Hz max 3 3x12LED 4000 Tc [K] [°] [mm²] 3x1-2,5 IP 44 F CE



# AKVEN EL-35-GN

**Kanlux**

Vodotesné halogénové svietidlo

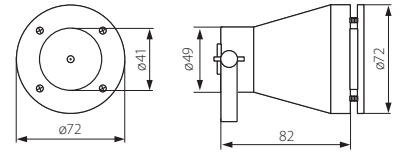

■ AKVEN EL-35-GN

■ teleso: zliatina hliníka

		EAN 		DKC SK bez DPH
AKVEN EL-35-GN	07140	5905339071408	zelená	27,92 €

- prispôbené dlhodobému ponoreniu do vody, hĺbka ponorenia max. 3m
- priechodka pro prívodný kábel o priemere 6mm

# MOSKITO T5

Elektrický lapač hmyzu so žiarivkou



■ MOSKITO T5

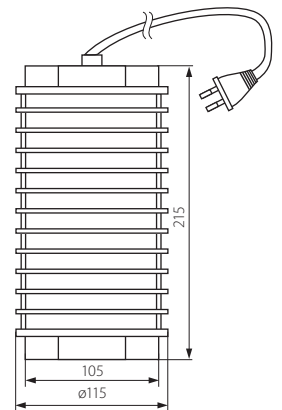

■ teleso svietidla: plast

		EAN 			DKC SK bez DPH
MOSKITO T5	12705	5905339127051	čierna	modrá	11,29 €

Ručná žiarivková lampička

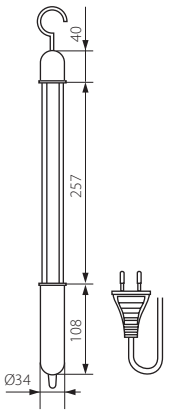

■ SOLO TOE10-230V

■ teleso svietidla: plast

		EAN 		DKC SK bez DPH
SOLO TOE10-230V	01100	5905339011008	čierna	5,34 €
230V~	8	4000	300 cm	20
230V~	8	4000	300 cm	0,2
230V~	8	4000	300 cm	0,2
230V~	8	4000	300 cm	0,2

■ nevýmenný zdroj svetla

## KODI NL / IKER NL

Zásuvková lampička

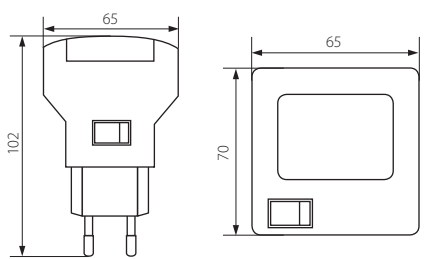

■ KODI NL4636-WHITE



■ IKER NL4631-WHITE

■ teleso svietidla: plast

		EAN 				DKC SK bez DPH
KODI NL4636-WHITE	11173	5905339111739	biela	biela	60	2,56 €
IKER NL4631-WHITE	11163	5905339111630	biela	biela	67	2,56 €
230V~	1	NEON	OFF		0,2	20
230V~	1	NEON	OFF		0,2	20
230V~	1	NEON	OFF		0,2	20

■ nevýmenný zdroj svetla





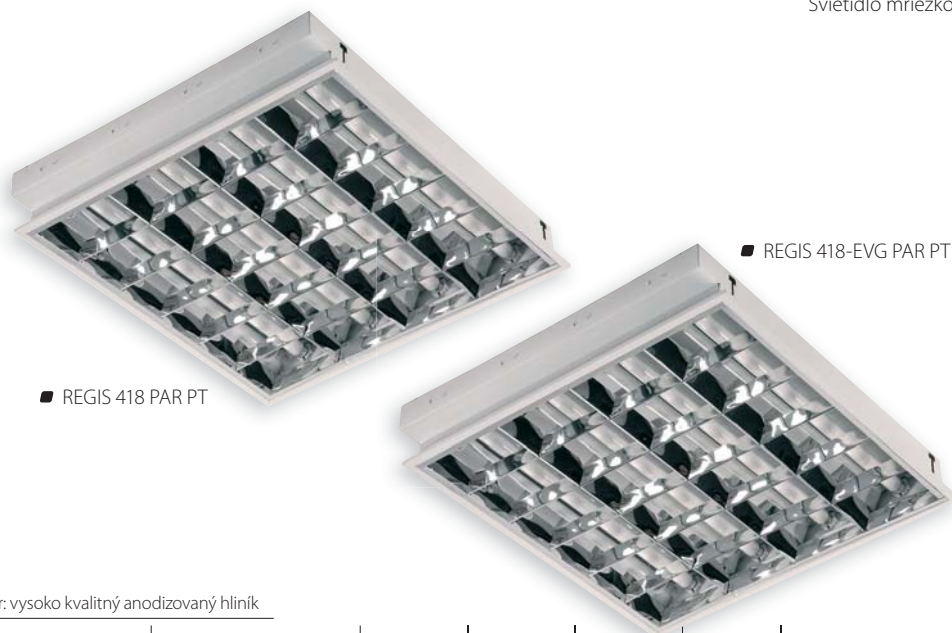
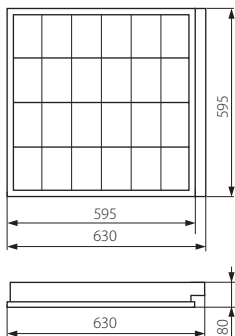

■ REGIS 418 PAR PT

■ REGIS 418-EVG PAR PT

■ teleso svietidla: oceľový plech / reflektor: vysoko kvalitný anodizovaný hliník

		EAN 					DKC SK bez DPH
REGIS 418 PAR PT	04650	5905339046505	biela	VVG ✓	B2	4100	35,29 €
REGIS 418-EVG PAR PT	04655	5905339046550	biela	EVG ✓	A2	3200	43,70 €

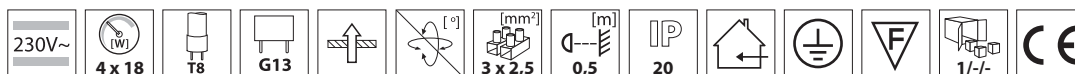

■ lamely rastru v tvare písmene V



■ model REGIS 418 PAR PT je vybavený kompenzačným kondenzátorom



■ päťce žiarivkových trubic zakryté reflektorom



■ balenie svietidla obsahuje plastovú rukavicu



■ ochranný vodič pripojený k mriežke slúži k ochrane pred úrazom elektrickým prúdom



■ v základnom telese dva otvory pre priebežné napájanie



■ model REGIS 418-EVG PAR PT obsahuje elektronický predradník zaisťujúci kompenzáciu účinníkov

krivky svetivosti  $\eta = 68\%$

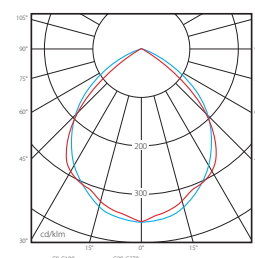

Svietidlo mriežkové vstavané

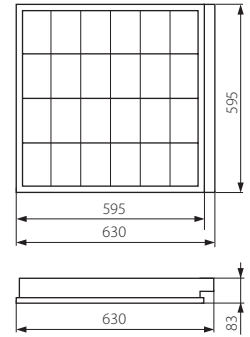

krivky svietivosti  $\eta = 52\%$

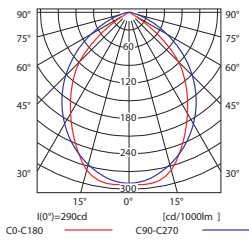

■ VOLKER 418 PT

■ teleso svetidla: ocelový plech

		EAN 		DKC SK bez DPH
VOLKER 418 PT	04825	5905339048257	biela	32,53 €



■ štandardný reflektor v tvare poloparaboly



■ ochranný vodič pripojený k mriežke slúži k ochrane pred úrazom elektrickým prúdom



■ ryhované priečne lamely v tvare „I“



■ v základnom telese otvory pre priebežné napájanie



■ päťce žiarivkových trubíc zakryté reflektorom

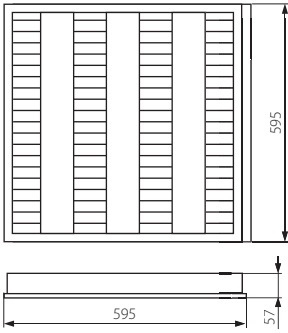

■ GRAF 414 PT-EVG

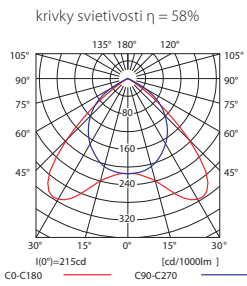

■ teleso svetidla: ocelový plech / reflektor: vysoko kvalitný anodizovaný hliník

		EAN 		DKC SK bez DPH
GRAF 414 PT-EVG	04830	5905339048301	biela	59,75 €



■ štandardný reflektor v tvare poloparaboly



■ ochranný vodič pripojený k mriežke slúži k ochrane pred úrazom elektrickým prúdom

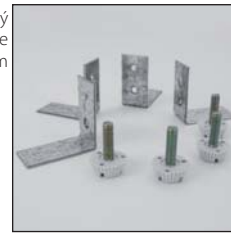

■ montážne držiaky slúžia- ce k inštalácii svetidla do sádkartonového pod- hladu súčasťou dodávky



■ lamely rastru v tvare písmene „V“



■ elektronický predradník s kompenzáciou účinníka



■ v základnom telese otvory pre priebežné napájanie



■ päťce žiarivko- vých trubic zakry- té reflektorom



■ balenie svetidla obsa- huje plastový rukavica



■ nízka výška svetidla

Svietidlo mriežkové prisadené

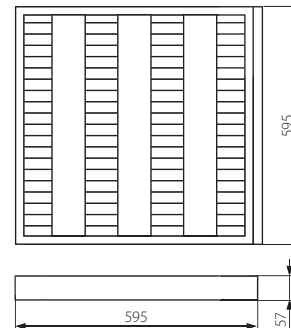

■ XEDOS 414 NT-EVG

■ teleso svetidla: oceľový plech / reflektor: vysoko kvalitný anodizovaný hliník

		EAN 		DKC SK bez DPH
NEW XEDOS 414 NT-EVG	04832	5905339048325	biela	59,75 €

--	--	--	--	--	--	--	--	--	--	--	--	--	--	--	--



■ štandardný reflektor v tvare poloparaboly



■ ochranný vodič pripojený k mriežke slúži k ochrane pred úrazom elektrickým prúdom



■ v základnom telese otvory pre priebežné napájanie



■ lamely rastru v tvare písmene „V“



■ elektronický predradník s kompenzáciou účinníka



■ nízka výška svetidla



■ päťce žiarivkových trubic zakryté reflektorom



■ balenie svetidla obsahuje plastovú rukavicu

NOTUS 218 PAR NT  
NOTUS 218-EVG PAR NT

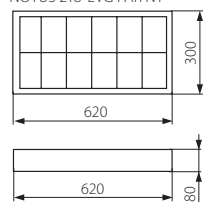

NOTUS 236 PAR NT  
NOTUS 236-EVG PAR NT

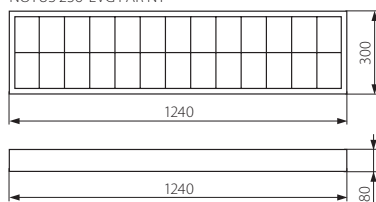

NOTUS 418 PAR NT  
NOTUS 418-EVG PAR NT

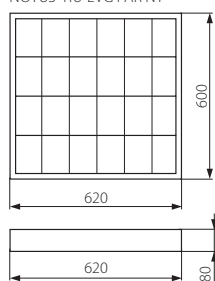

- NOTUS 418 PAR NT
- NOTUS 418-EVG PAR NT



- NOTUS 218 PAR NT
- NOTUS 218-EVG PAR NT



- NOTUS 236 PAR NT
- NOTUS 236-EVG PAR NT

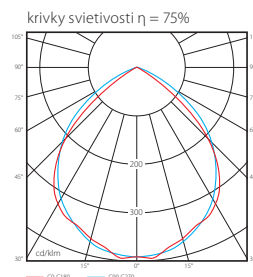
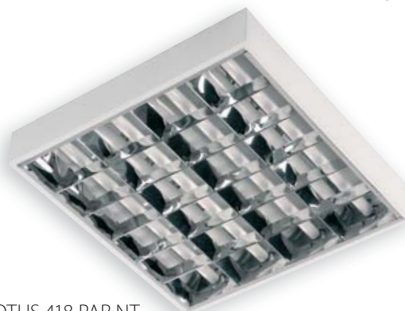

■ NOTUS 236 PAR NT

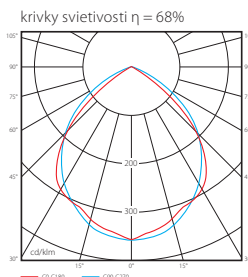

■ NOTUS 418 PAR NT

■ teleso svetidla: oceľový plech / reflektor: vysoko kvalitný anodizovaný hliník

NEW  
NEW

			EAN						DKC SK bez DPH
NOTUS 218 PAR NT	07890	5905339078902	biela	2 x 18	VVG ✓	B2	2470	35,29 €	
NOTUS 218-EVG PAR NT	07891	5905339078919	biela	2 x 18	EVG ✓	A2	2030	37,04 €	
NOTUS 236 PAR NT	04652	5905339046529	biela	2 x 36	VVG ✓	B2	4500	37,04 €	
NOTUS 236-EVG PAR NT	04657	5905339046574	biela	2 x 36	EVG ✓	A2	3500	38,54 €	
NOTUS 418 PAR NT	04651	5905339046512	biela	4 x 18	VVG ✓	B2	4300	39,70 €	
NOTUS 418-EVG PAR NT	04656	5905339046567	biela	4 x 18	EVG ✓	A2	3350	45,70 €	

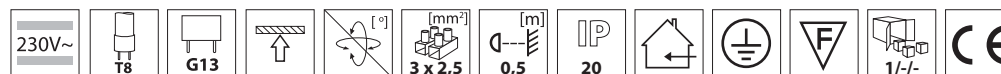

■ lamely rastru v tvare písmene „V“



■ balenie svetidla obsahuje plastovú rukavicu



■ modely NOTUS 218 PAR NT, NOTUS 236 PAR NT, NOTUS 418 PAR NT vybavené kompenzáciou účinníkov



■ päťce žiarivkových trubíc zakryté reflektorom

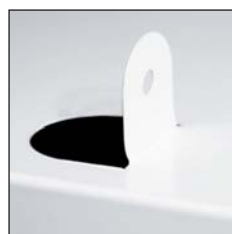

■ svetidla pripravené pre zavesenie



■ v základnom telese otvory pre priebežné napájanie



■ ochranný vodič pripojený k mriežke slúži k ochrane pred úrazom elektrickým prúdom



■ ideálne rovný povrch vonkajšej časti svetidla



■ typy NOTUS 218-EVG PAR NT, NOTUS 236-EVG PAR NT a NOTUS 418-EVG PAR NT vybavené elektronickým predradníkom zaisťujúci kompenzáciu účinníkov

Svietidlo mriežkové prisadené

■ TOKEN 418 NT



TOKEN 418 NT

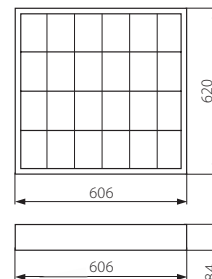

TOKEN 236 NT

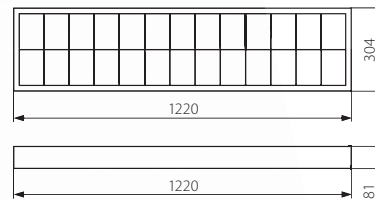

■ TOKEN 236 NT



krivky svietivosti  $\eta = 57\%$

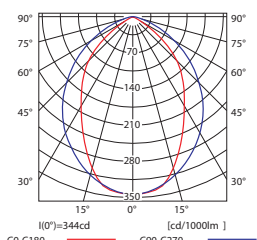

■ TOKEN 236 NT

krivky svietivosti  $\eta = 52\%$

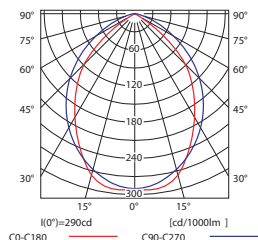

■ TOKEN 418 NT

■ teleso svietidla: oceľový plech

		EAN 				DKC SK bez DPH
TOKEN 236 NT	04827	5905339048271	biela	2 x 36	4370	31,53 €
TOKEN 418 NT	04826	5905339048264	biela	4 x 18	4220	32,53 €

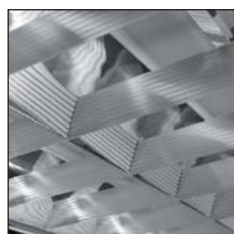

■ štandardný reflektor v tvare poloparaboly



■ ochranný vodič pripojený k mriežke slúži k ochrane pred úrazom elektrickým prúdom



■ v základnom telese otvory pre priebežné napájanie



■ ryhované priečne lamely v tvare „I“



■ svietidla pripravené pre zavesenie



■ päťce žiarivkových trubíc zakryté reflektorom



■ ideálne rovný povrch vonkajšej časti svietidla

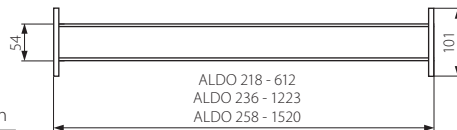
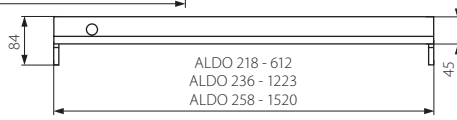
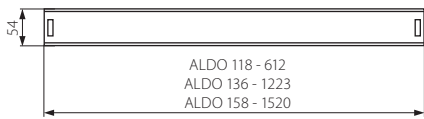
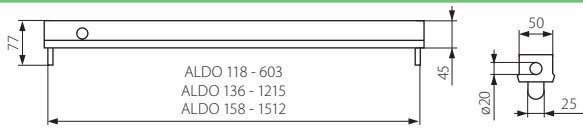

teleso svetidla: oceľový plech

Kanlux	Kanlux	EAN		[W]	[g]	DKC SK bez DPH
ALDO 118	04600	5905339046000	biela	18	1110	10,56 €
ALDO 136	04602	5905339046024	biela	36	1530	13,54 €
ALDO 158	04604	5905339046048	biela	58	2030	18,29 €
ALDO 218	04601	5905339046017	biela	2 x 18	1130	12,51 €
ALDO 236	04603	5905339046031	biela	2 x 36	2190	21,54 €
ALDO 258	04605	5905339046055	biela	2 x 58	2970	29,41 €

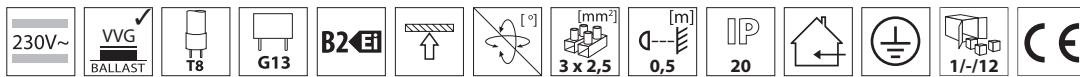

Žiarivkové svetidlo

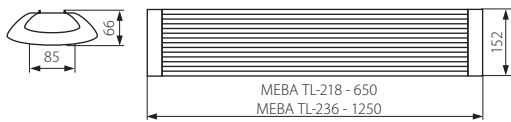

Žiarivkové svetidlo



teleso: kovový výlisok / difúzor: plast

Kanlux	Kanlux	EAN		[W]		[g]	DKC SK bez DPH
MEBA TL-218	07250	5905339072504	biela	2 x 18	1/-/8	1500	15,47 €
MEBA TL-218/OP	07252	5905339072528	biela	2 x 18	1/-/8	1350	15,47 €
MEBA TL-236	07251	5905339072511	biela	2 x 36	1/-/4	2750	25,85 €
MEBA TL-236/OP	07253	5905339072535	biela	2 x 36	1/-/4	2575	25,85 €

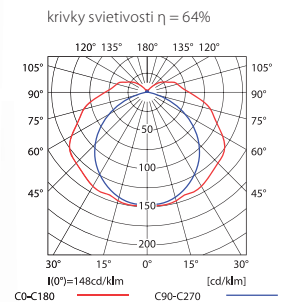

krivky svetivosti η = 64%

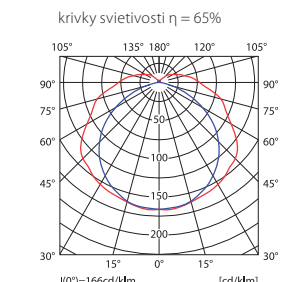

krivky svetivosti η = 65%

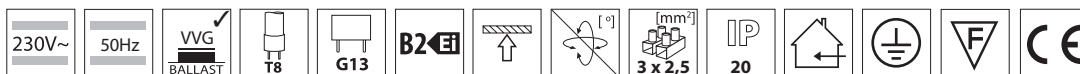

## Svietidlo lineárne

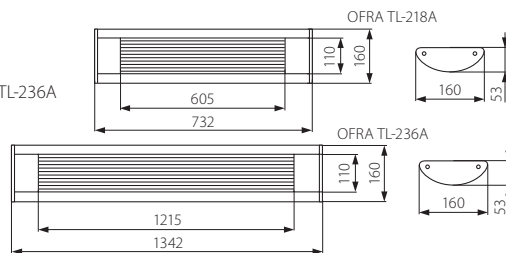
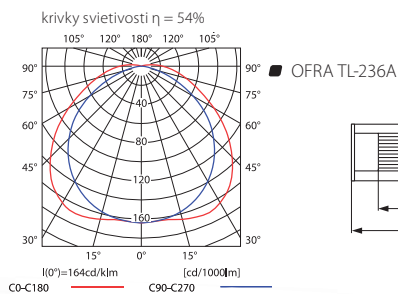
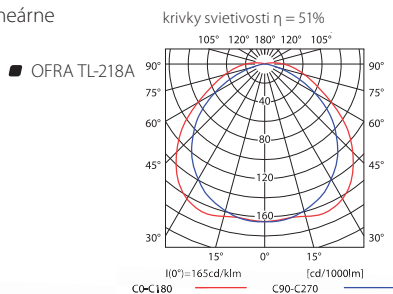

teleso: oceľ / odrazová plocha: hliník / tienidlo/difúzor: plast

Kanlux	Kanlux	EAN		[W]		[g]	DKC SK bez DPH
OFRA TL-218A-SR	07092	5905339070920	strieboiná	2 x 18	1/-/10	1570	19,12 €
OFRA TL-218A-W	07090	5905339070906	biela	2 x 18	1/-/10	1570	17,92 €
OFRA TL-236A-SR	07093	5905339070937	strieboiná	2 x 36	1/-/6	2900	29,77 €
OFRA TL-236A-W	07091	5905339070913	biela	2 x 36	1/-/6	2900	24,83 €

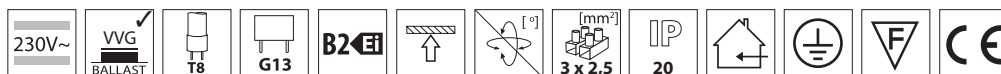

## Svietidlo lineárne

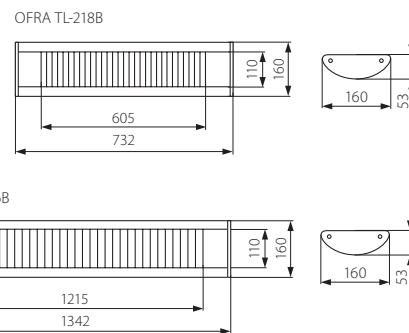
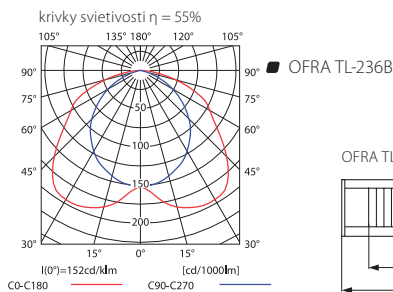
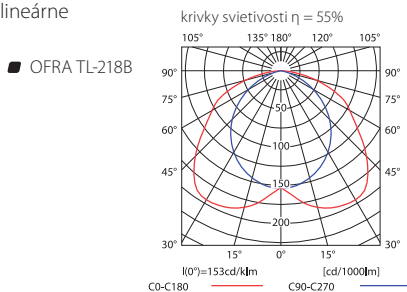

teleso: oceľ / odrazová plocha: hliník / raster: plast

Kanlux	Kanlux	EAN		[W]		[g]	DKC SK bez DPH
OFRA TL-218B-SR	07097	5905339070975	strieboiná	2 x 18	1/-/10	1570	19,12 €
OFRA TL-218B-W	07095	5905339070951	biela	2 x 18	1/-/10	1570	17,92 €
OFRA TL-236B-SR	07098	5905339070982	strieboiná	2 x 36	1/-/6	2900	29,77 €
OFRA TL-236B-W	07096	5905339070968	biela	2 x 36	1/-/6	2900	24,83 €

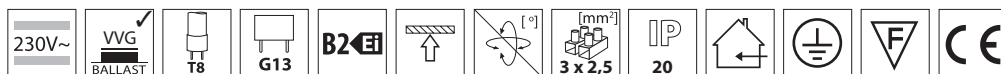





MAH-1118 – 670  
MAH-1136 – 1270  
MAH-1158 – 1570

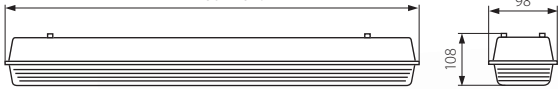

■ MAH-1158/A



krivky svietivosti  $\eta = 72\%$

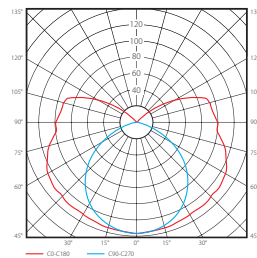

■ MAH 1118

krivky svietivosti  $\eta = 86\%$

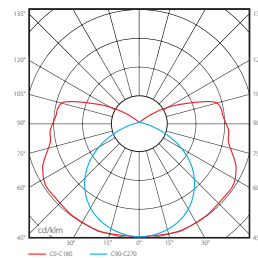

■ MAH 1136

krivky svietivosti  $\eta = 80\%$

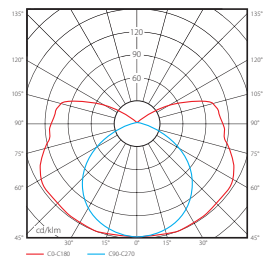

■ MAH 1158

■ teleso a spona svietidla: PC s prímiesou ABS / difúzor: PC

Kanlux	Kanlux	EAN					DKC SK bez DPH
MAH-1118/A	03970	5905339039705	šedá	18	1/-/10	1580	20,71 €
MAH-1136/A	03972	5905339039729	šedá	36	1/-/6	2600	30,57 €
MAH-1158/A	03974	5905339039743	šedá	58	1/-/6	3120	38,80 €



■ jednoduchá montáž svietidla s použitím priložených príchytek



■ vysoká odolnosť proti UV žiareniu, svietidlo se nezbarvuje ani po dlhšom čase ani v prípade, že je nainštalované v miestach s vysokou slnečnou intenzitou



■ vysoká pevnosť kvôli telesu svietidla vyrobeného z PC s prímiesou ABS



■ v základnom telese svietidla pripravený otvor pre priebežné zapojenie



■ svietidla jsou odolná proti strekajúcej a tryskajúcej vode a sú prachotesné



■ bezpečnostná priechodka slúžiacia pre vstup prívodného napájacieho kábelu

Svietidlo prachotesné

MAH-1218 – 670  
MAH-1236 – 1270  
MAH-1258 – 1570

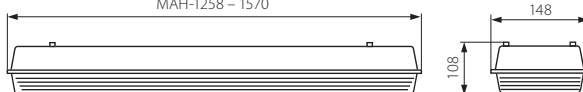

■ MAH-1218/A

krivky svietivosti  $\eta = 70\%$

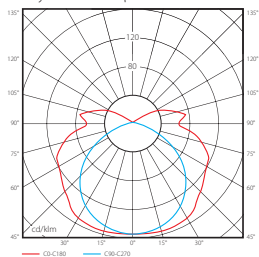

■ MAH 1218

krivky svietivosti  $\eta = 74\%$

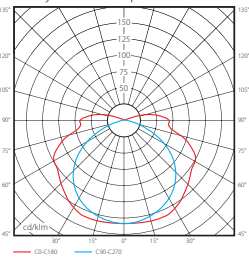

■ MAH 1236

krivky svietivosti  $\eta = 73\%$

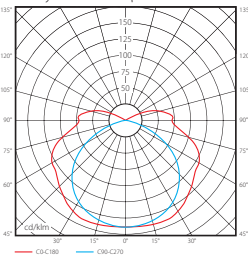

■ MAH 1258

■ teleso a spona svietidla: PC s prímiesou ABS / difúzor: PC

Kanlux	Kanlux	EAN		[W]	BALLAST	Ei		[g]	DKC SK bez DPH
MAH-1218/A	03971	5905339039712	šedá	2 x 18	VVG ✓	B2	1/-/8	2090	25,86 €
MAH-1236/A	03973	5905339039736	šedá	2 x 36	VVG ✓	B2	1/-/4	3800	40,96 €
MAH-1236-EVG/A	04273	5905339042736	šedá	2 x 36	EVG ✓	A2	1/-/4	2850	42,62 €
MAH-1258/A	03975	5905339039750	šedá	2 x 58	VVG ✓	B2	1/-/4	5110	56,06 €
MAH-1258/A/CP	03985	5905339039859	šedá	2 x 58	VVG ✓	B2	1/-/4	5120	57,76 €

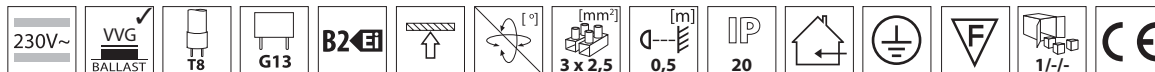

■ jednoduchá montáž svietidla s použitím priložených príchytiek



■ vysoká odolnosť proti UV žiareniu, svietidlo se nezbarvuje ani po dlhšom čase ani v prípade, že je nainštalované v miestech s vysokou slnečnou intenzitou



■ vysoká pevnosť kvôli telesu svietidla vyrobeného z PC s prímiesou ABS



■ v základnom telesu svietidla pripravený otvor pre priebežné zapojenie



■ svietidla jsou odolná proti strekajúcej a tryskajúcej vode a sú prachotesné



■ bezpečnostná priechodka slúžacia pre vstup prievodného napájacieho káblu



■ model MAH-1236-EVG/A obsahuje elektronický predradník zaisťujúci kompenzáciu účinníka



■ svietidlo typu MAH-1258/A/CP je vybavené kompenzáciou účinníka



MAH-1118 – 670  
MAH-1136 – 1270  
MAH-1158 – 1570

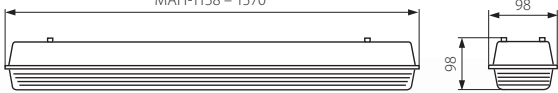

■ MAH-1136/A-PS

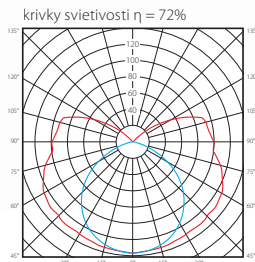

■ MAH 1118

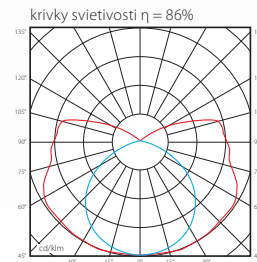

■ MAH 1136

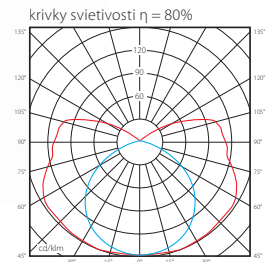

■ MAH 1158

■ teleso a spona svietidla: ABS / difúzor: PS

Kanlux	Kanlux	EAN		[W]		[g]	DKC SK bez DPH
MAH-1118/A-PS	04510	5905339045102	šedá	18	1/-/10	1580	17,83 €
MAH-1136/A-PS	04511	5905339045119	šedá	36	1/-/6	2590	24,60 €
MAH-1158/A-PS	04512	5905339045126	šedá	58	1/-/6	3130	32,80 €



■ jednoduchá montáž svietidla s použitím priložených príchytek



■ v základnom telese svietidla pripravený otvor pre priebežné zapojenie



■ svietidla sú odolná proti strekajúcej a tryskajúcej vode a sú prachotesné



■ bezpečnostná prechodka slúžacia pre vstup prievodného napájacieho kabeľu

Svietidlo prachotesné



■ MAH-1236/A-PS

krivky svietivosti  $\eta = 70\%$

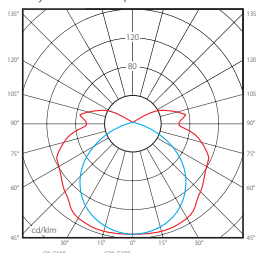

■ MAH 1218

krivky svietivosti  $\eta = 74\%$

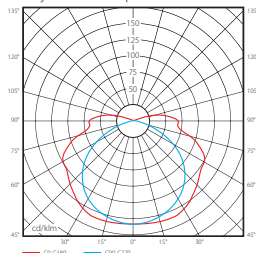

■ MAH 1236

krivky svietivosti  $\eta = 73\%$

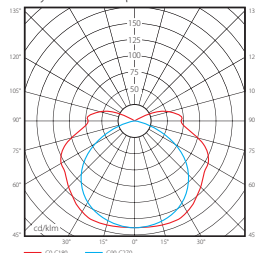

■ MAH 1258

■ teleso a spona svietidla: ABS / difúzor: PS

		EAN 							DKC SK bez DPH
MAH-1218/A-PS	04513	5905339045133	šedá	2 x 18	VVG ✓	B2	1/-/8	2080	20,71 €
MAH-1236/A-PS	04514	5905339045140	šedá	2 x 36	VVG ✓	B2	1/-/4	3790	36,08 €
MAH-1236EVG/A-PS	04285	5905339042859	šedá	2 x 36	EVG ✓	A2	1/-/4	2860	36,68 €
MAH-1258/A-PS	04515	5905339045157	šedá	2 x 58	VVG ✓	B2	1/-/4	5100	50,29 €



■ jednoduchá montáž svietidla s použitím priložených príchytiok



■ bezpečnostná priechodka slúžacia pre vstup prievodného napájacieho kábelu



■ model MAH-1236-EVG/A obsahuje elektronický predradník zaisťujúci kompenzáciu účinníkov



■ v základnom telese svietidla pripravený otvor pre priebežné zapojenie



■ svietidla jsou odolná proti strekajúcej a tryskajúcej vode a sú prachotesné

Svietidlo žiarivkové prisadené

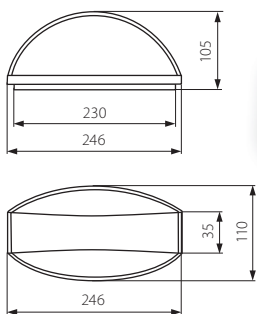

■ VOLIN EL-9-W



■ VOLIN EL-9-B



■ těleso svítidla: ABS / difúzor: PC

		EAN		DKC SK bez DPH
VOLIN EL-9-W	04806	5905339048066	biela	16,56 €
VOLIN EL-9-B	04805	5905339048059	čierna	16,56 €

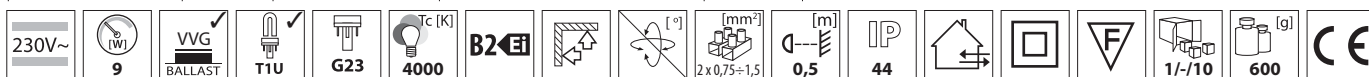
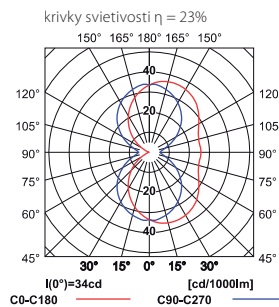

- vysoká odolnosť proti UV žiareniu
- vysoká odolnosť proti nárazu

## PORTOS 11

Svietidlo žiarivkové prisadené

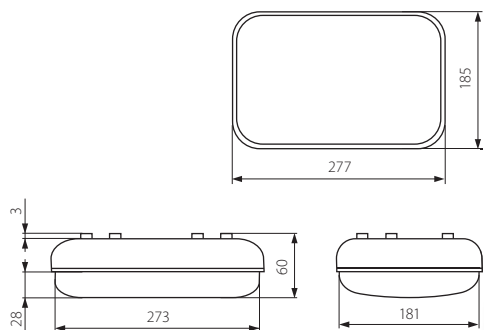

■ PORTOS 11

■ teleso svietidla: ABS / difúzor: polykarbonát PC

		EAN		DKC SK bez DPH
PORTOS 11	04671	5905339046710	biela	13,74 €

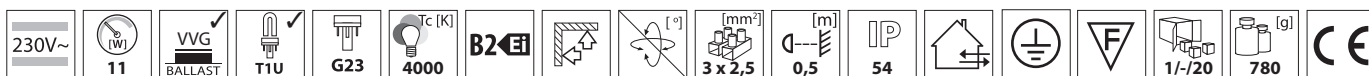
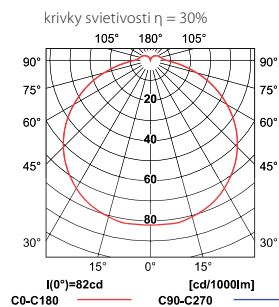

- vysoká odolnosť proti UV žiareniu
- vysoká odolnosť proti nárazu

Svietidlo s vyšším krytím

krivky svietivosti  $\eta = 24\%$

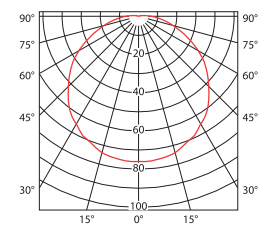

■ LUVEN MX-216/21W-W

krivky svietivosti  $\eta = 24\%$

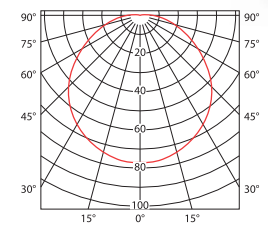

■ LUVEN MX-218/38W-W

■ teleso svietidla: ABS / difúzor: polykarbonát PC

Kanlux	Kanlux	EAN		[W]	[g]	DKC SK bez DPH
LUVEN MX-216/21W-W	04240	5905339042408	biela	21	1100	33,56 €
LUVEN MX-218/38W-W	04241	5905339042415	biela	38	260	42,06 €

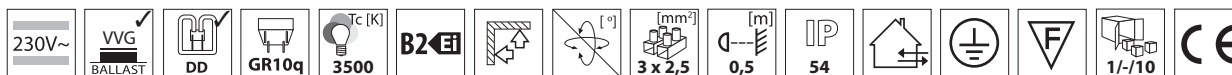

- vysoká odolnosť proti UV žiareniu
- vysoká odolnosť proti nárazu

■ LUVEN MX-218/38W-W

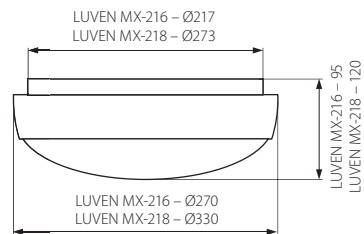

## VISTO DL

Svietidlo s vyšším krytím

krivky svietivosti  $\eta = 40\%$

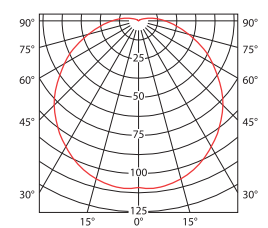

■ VISTO DL-750

krivky svietivosti  $\eta = 40\%$

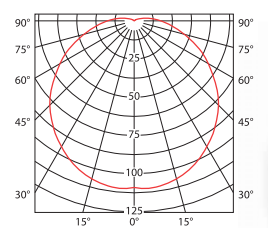

■ VISTO DL-2130

■ teleso svietidla a tienidlo: polykarbonát PC

Kanlux	Kanlux	EAN		[W]			[g]	DKC SK bez DPH
VISTO DL-750	04991	5905339049919	biela	max 75	E27	odľahčovacia svorka 2 x 1,5mm <sup>2</sup>	1250	25,73 €
VISTO DL-2130	04990	5905339049902	biela	2 x 13	T2U G24d	svorka 3 x 2,5mm <sup>2</sup>	1840	34,85 €



- VISTO DL 2130 patri do I. triedy ochrany pred úrazom el. prúdom, VISTO DL-750 patri do II. triedy ochrany pred úrazom el. prúdom
- VISTO DL-2130 - súčasťou svietidla je indukčný predradník, trieda energetickej účinnosti B2

Svietidlo s vyšším krytím

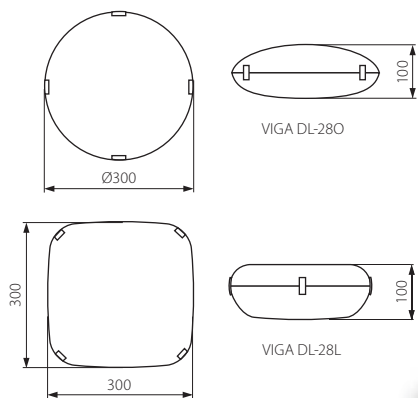

■ VIGA DL-280

■ VIGA DL-28L

krivky svetivosti  $\eta = 43\%$

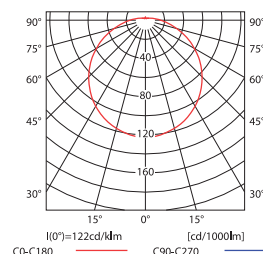

CO-C180 I(0°)=122cd/ldm C90-C270 [cd/1000lm]

■ VIGA DL

■ teleso svetidla: ABS / difúzor: polykarbonát PC

<b>Kanlux</b>	<b>Kanlux</b>	EAN		[g]	DKC SK bez DPH
VIGA DL-280	04851	5905339048516	biela	1330	29,08 €
VIGA DL-28L	04852	5905339048523	biela	1500	30,24 €

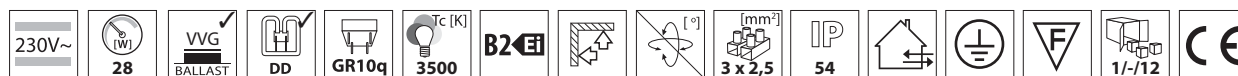

## IVO DL-38

Svietidlo s vyšším krytím

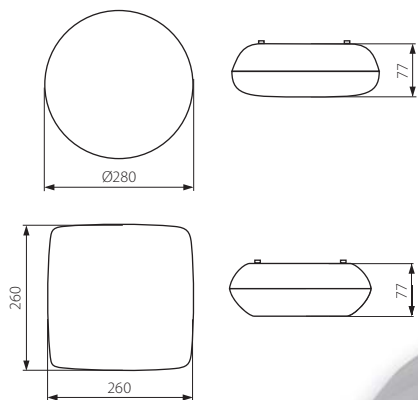

■ IVO DL-38L

■ IVO DL-380

■ teleso svetidla: ABS / difúzor: polykarbonát PC

<b>Kanlux</b>	<b>Kanlux</b>	EAN		[g]	DKC SK bez DPH
NEW IVO DL-380	07310	5905339073105	biela	1500	21,85 €
NEW IVO DL-38L	07311	5905339073112	biela	1580	21,85 €

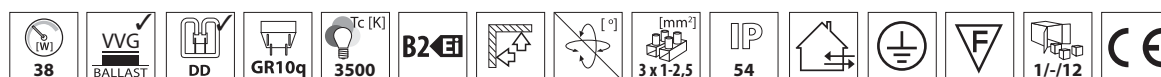

# MARC DL-60

**Kanlux**

Svietidlo s vyšším krytím

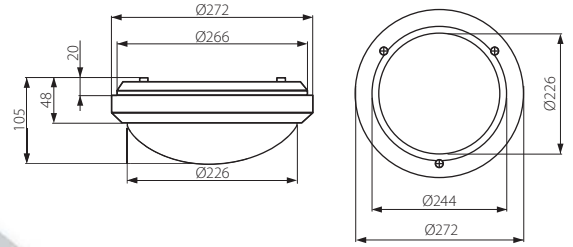
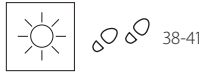

■ MARC DL-60

■ teleso svietidla a tienidlo: polykarbonát PC

		EAN 		DKC SK bez DPH
MARC DL-60	07015	5905339070159	biela	13,97 €

# FAVOR DL-60

Svietidlo s vyšším krytím

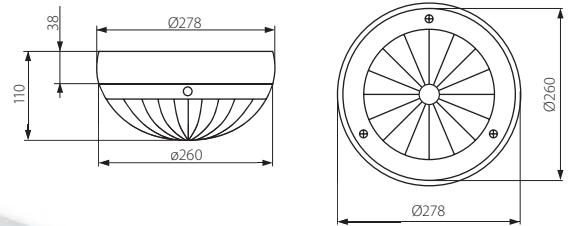
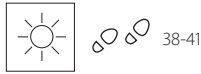

■ FAVOR DL-60

■ teleso svietidla a tienidlo: polykarbonát PC

		EAN 		DKC SK bez DPH
FAVOR DL-60	07020	5905339070203	biela	21,34 €



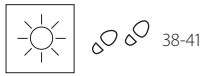
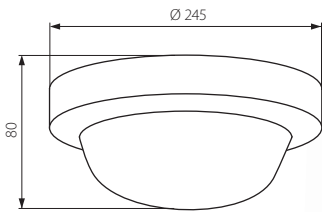

Svietidlo s vyšším krytím



■ 7070T

■ teleso svietidla: plast / difúzor: sklo

		EAN 		DKC SK bez DPH
7070T	70527	5905339705273	biela	9,92 €

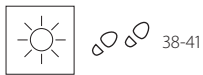
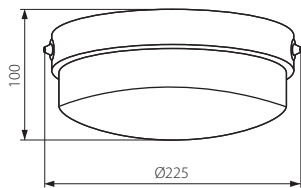

Svietidlo s vyšším krytím



■ TUNA S1101-W

■ teleso svietidla: plast / difúzor: sklo

		EAN 		DKC SK bez DPH
TUNA S1101-W	04260	5905339042606	biela	9,00 €

Svietidlo s vyšším krytím

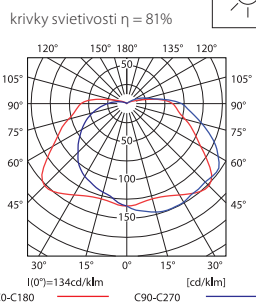
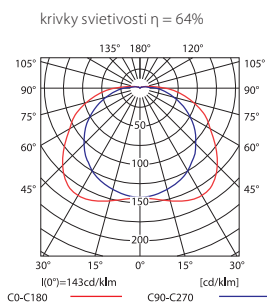

38-41, 45

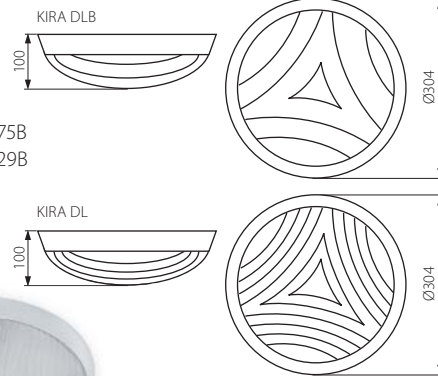

■ KIRA DL-29

■ KIRA DL-75

■ KIRA DL-75B  
■ KIRA DL-29B

■ KIRA DL-75  
■ KIRA DL-29

■ teleso svietidla: ABS / difúzor: PC / reflektor: hliník

			EAN		[W]				[g]	DKC SK bez DPH
<b>NEW</b>	KIRA DL-75B	07900	5905339079008	biela	max 75		odlahčovacia svorka 2 x 0,75-1,5mm <sup>2</sup>		620	14,11 €
	KIRA DL-75	07190	5905339071903	biela	max 75		odlahčovacia svorka 2 x 0,75-1,5mm <sup>2</sup>		620	14,11 €
<b>NEW</b>	KIRA DL-29B	07901	5905339079015	biela	2 x 9		svorka 3 x 2,5mm <sup>2</sup>		970	21,21 €
	KIRA DL-29	07191	5905339071910	biela	2 x 9		svorka 3 x 2,5mm <sup>2</sup>		970	21,21 €



■ KIRA DL-29 a KIRA DL-29B patri do I. triedy ochrany a KIRA DL-75 a KIRA DL-75B patri do II. triedy ochrany pred úrazom el. prúdom ■ vysoká odolnosť proti UV žiareniu  
 ■ KIRA DL-29a KIRA DL-29B súčasťou svietidla je indukčný predradník, trieda energetickej účinnosti B4 ■ vysoká odolnosť proti nárazu

## INES 7061

Svietidlo s vyšším krytím



38-41

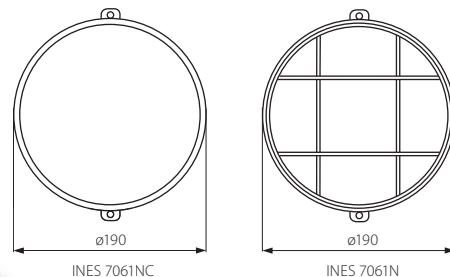

■ INES 7061NC



■ INES 7061N

■ teleso svietidla: bakelit / difúzor: sklo / ochranná mriežka difuzora INES 7061N: drátový koš

			EAN		[g]	DKC SK bez DPH
INES 7061NC	70526	5905339705266	biela	1050	13,84 €	
INES 7061N	70525	5905339705259	biela	1066	14,57 €	

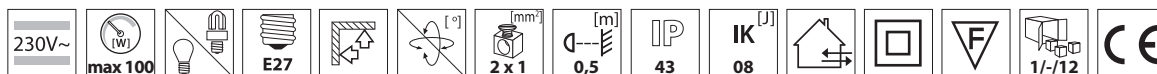

Svietidlo s vyšším krytím

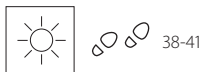
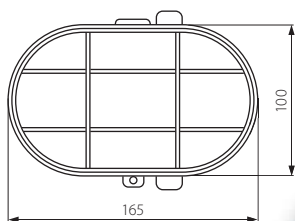

■ MILO 7040T



■ MILO 7040T/P

■ teleso svetidla: plast / difúzor: sklo / ochranná mriežka difuzoru MILO 7040T: drátený koš / ochranná mriežka difuzoru MILO 7040T/P: plast

		EAN 			DKC SK bez DPH
MILO 7040T	70522	5905339705228	šedá	450	5,91 €
MILO 7040T/P	70523	5905339705235	šedá	500	5,84 €

--	--	--	--	--	--	--	--	--	--	--	--	--	--	--

## HERMI 7063NB

Svietidlo s vyšším krytím

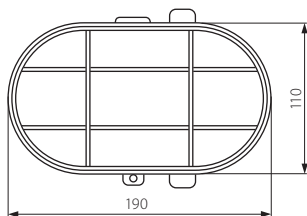

■ HERMI 7063NB

■ teleso svetidla: bakelit / difúzor: sklo / ochranná mriežka difuzora: drátený koš

		EAN 			DKC SK bez DPH
HERMI 7063NB	70524	5905339705242	šedá	9,29 €	

--	--	--	--	--	--	--	--	--	--	--	--	--	--	--	--

# TURK DL-60

**Kanlux**

Svietidlo s vyšším krytím



38-41

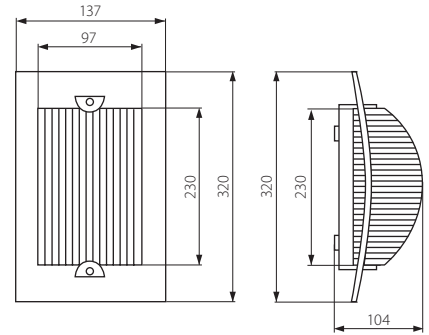

■ TURK DL-60

■ teleso svietidla a tienidlo: polykarbonát PC

		EAN 		DKC SK bez DPH
TURK DL-60	07025	5905339070258	biela	13,97 €

--	--	--	--	--	--	--	--	--	--

- vysoká odolnosť proti UV žiareniu
- vysoká odolnosť proti nárazu

# FRODO DL-60

Svietidlo s vyšším krytím



38-41

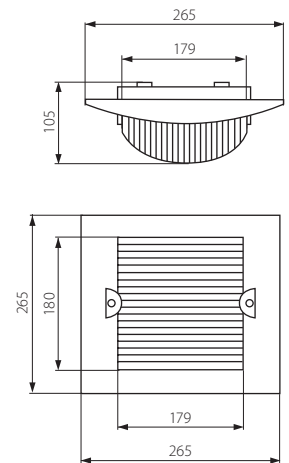

■ základ a sklenené tienidlo: polykarbonát PC / ozdobný rám: umelá hmota

		EAN 		DKC SK bez DPH
FRODO DL-60	07340	5905339073402	matný chróm	13,49 €

--	--	--	--	--	--	--	--	--	--	--

- vysoká odolnosť proti UV žiareniu
- vysoká odolnosť proti nárazu



Svietidlo s vyšším krytím

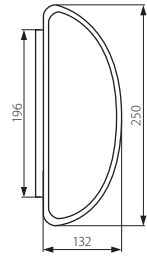
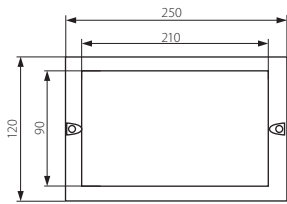

38-41



■ SHARK EL-60

■ základňa a rámik: zliatina hliníka / tienidlo: polykarbonát PC

		EAN 		DKC SK bez DPH
SHARK EL-60	07011	5905339070111	šedá	21,91 €
				710

- vysoká odolnosť proti UV žiareniu
- vysoká odolnosť proti nárazu



Svietidlo s vyšším krytím

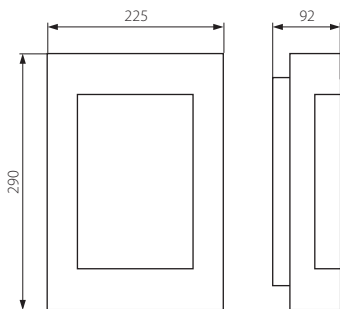

38-41



■ VITAM EL-60

■ teleso svietidla: PC / rám: nerezová oceľ

		EAN 		DKC SK bez DPH
VITAM EL-60	04865	5905339048653	matný chróm	26,99 €
				615

- vysoká odolnosť proti UV žiareniu
- vysoká odolnosť proti nárazu

Záhradné svetidlo nástenné



■ BART EL-135

■ BART EL-235

■ BART EL-140

■ BART EL-160



34-36,  
38-41  
46,52

BART EL-135

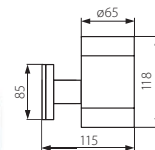

BART EL-140

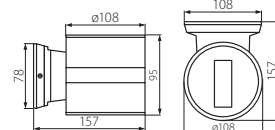
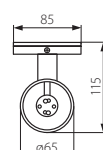

BART EL-160

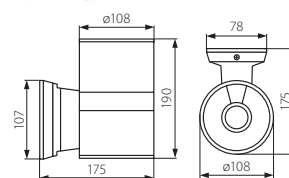

■ teleso: hliníková zliatina / difúzor: tvrdené sklo

Kanlux	Kanlux	EAN	Farba	[W]	Typ žiarovky	Typ žiarovky	Typ žiarovky	[g]	DKC SK bez DPH
BART EL-135	07079	5905339070791	šedá	max 35				450	14,54 €
BART EL-235	07080	5905339070807	šedá	2 x max 35	JDR	GU10	1/-/18	520	20,35 €
<b>NEW</b> BART EL-140	07083	5905339070838	šedá	max 40	G9	G9	1/-/18	810	17,33 €
BART EL-160	07081	5905339070814	šedá	max 60			1/-/12	970	27,92 €
BART EL-260	07082	5905339070821	šedá	2 x max 60		E27	1/-/12	1410	31,30 €

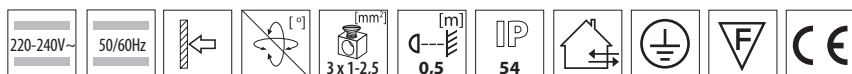

■ typy BART EL-140, BART EL-235, BART EL-260 svietí v dvoch smeroch, typy BART EL-135, BART EL-160 svietí v jednom smere

BART EL-235

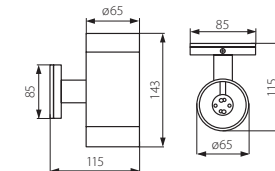

BART EL-260

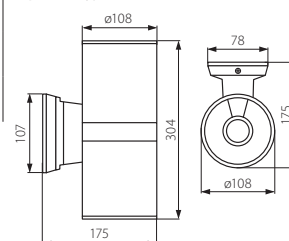

# ZEW EL-235

Záhradné svetidlo nástenné



■ ZEW EL-235J

■ ZEW EL-235U

ZEW EL-235J

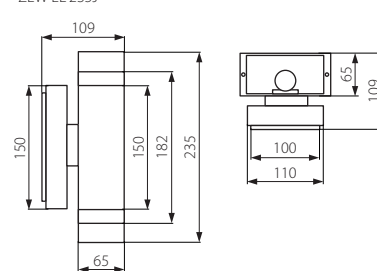

ZEW EL-235U

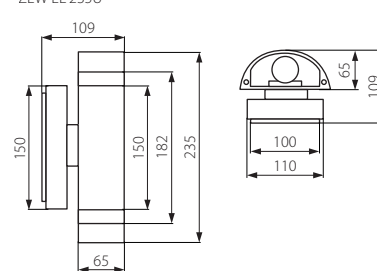

■ teleso: hliníková zliatina / difúzor: tvrdené sklo

Kanlux	Kanlux	EAN	Farba	[g]	DKC SK bez DPH
ZEW EL-235J	04971	5905339049711	šedá	1150	38,54 €
ZEW EL-235U	04970	5905339049704	šedá	1020	38,54 €

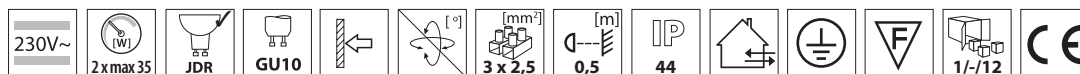

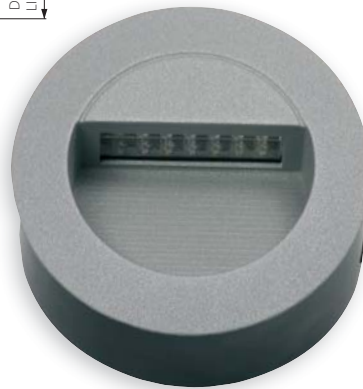
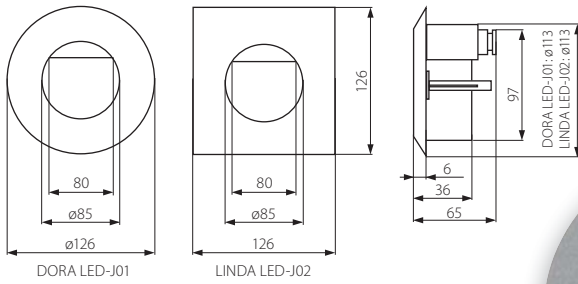

teleso svetidla: hliníková zliatina / difúzor: plast

DORA LED-J01

LINDA LED-J02

		EAN 				DKC SK bez DPH
DORA LED-J01	04680	5905339046802	šedá	biela	290	27,19 €
LINDA LED-J02	04681	5905339046819	šedá	biela	330	27,19 €

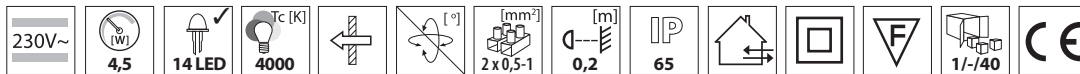

- možnosť propojenia až 5 svetidiel
- nevyhnutelný zdroj svetla
- svetidlo obsahuje plastovú krabičku pre zabudovanie

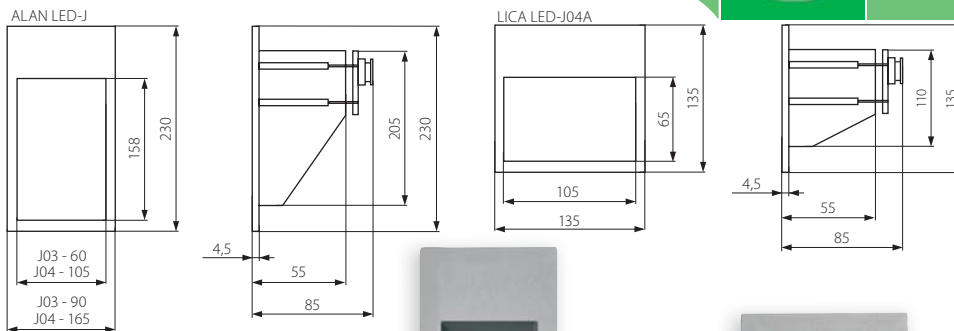

ALAN LED-J03

ALAN LED-J04

LICA LED-J04A

teleso svetidla: hliníková zliatina / difúzor: plast

		EAN 				DKC SK bez DPH	
ALAN LED-J03	04682	5905339046826	šedá	15 LED ✓	1/-/30	510	30,51 €
ALAN LED-J04	04683	5905339046833	šedá	18 LED ✓	1/-/30	640	39,14 €
LICA LED-J04A	04684	5905339046840	šedá	18 LED ✓	1/-/20	510	35,75 €

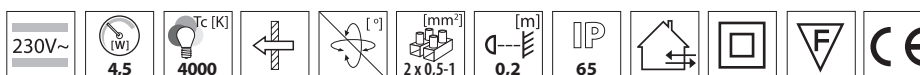

- možnosť propojenia až 5 svetidiel
- nevyhnutelný zdroj svetla
- svetidlo obsahuje plastovú krabičku pre zabudovanie

Vstavané svietidlo LED



■ KORNAT DL-LED24B



■ KORNAT DL-LED24A

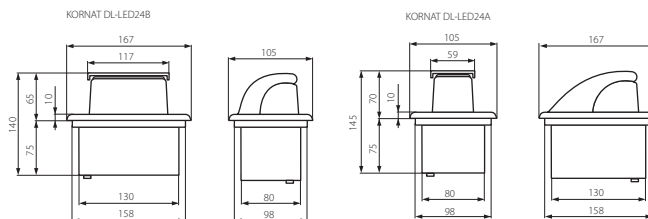

■ teleso svietidla: hliník / ochranný difúzor: plast

		EAN 			DKC SK bez DPH
NEW KORNAT DL-LED24A	07740	5905339077400	šedá	570	19,96 €
NEW KORNAT DL-LED24B	07741	5905339077417	šedá	610	19,96 €

220-240V~	50Hz							IP					
		2	24	3500-4500	30000		3 x 1-2,5	54				1/-/8	

■ montážna krabička súčasťou dodávky

## TAXI LED

Vstavané svietidlo LED



■ TAXI LED9KW WW-C/M  
■ TAXI LED9KW WH-C/M

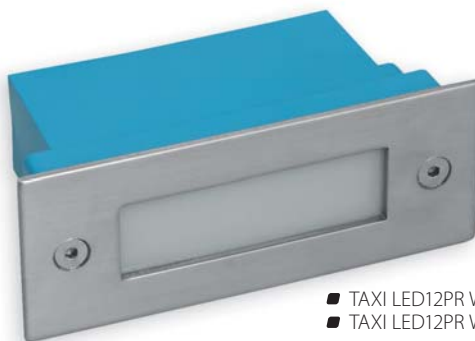

■ TAXI LED12PR WW-C/M  
■ TAXI LED12PR WH-C/M

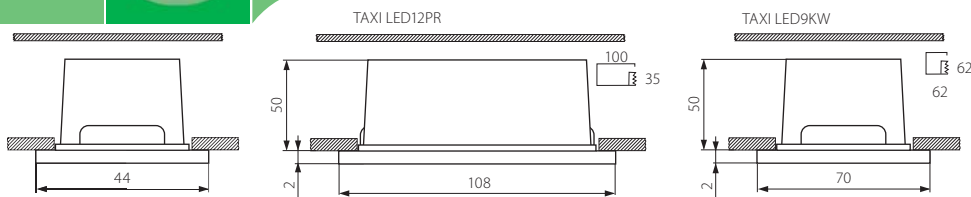

■ teleso svietidla: kovový odliatok / difúzor: sklo / železný panel: nerezová oceľ

		EAN 						DKC SK bez DPH
TAXI LED9KW WW-C/M	04392	5905339043924	matný chróm	9 LED ✓	teplá biela	2700	200	13,74 €
TAXI LED9KW WH-C/M	04390	5905339043900	matný chróm	9 LED ✓	biela	4000	200	13,74 €
TAXI LED12PR WW-C/M	04393	5905339043931	matný chróm	12 LED ✓	teplá biela	2700	210	14,21 €
TAXI LED12PR WH-C/M	04391	5905339043917	matný chróm	12 LED ✓	biela	4000	210	14,21 €

230V~					IP					
	1,5		2 x 0,75mm²	15 cm	54				1/10/40	

■ imbus kľúč súčasťou dodávky svietidla  
■ nevyhnutelný zdroj svetla



Nájazdové svetidlo LED

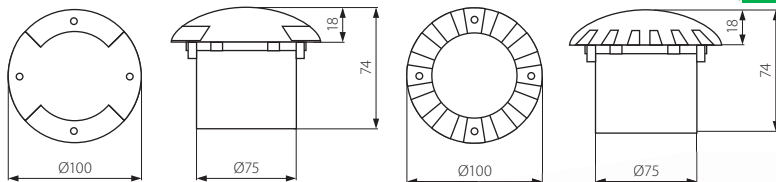

ROGER DL-2-LED6

ROGER DL-LED12



■ ROGER DL-2-LED6

■ ROGER DL-LED12



■ kryt: oceľový plech / panel: hliníková zliatina / sklo: umelá hmota

<b>Kanlux</b>	<b>Kanlux</b>	EAN			[g]	DKC SK bez DPH
ROGER DL-2-LED6	07281	5905339072818	šedá	chladno biela	270	15,70 €
ROGER DL-LED12	07280	5905339072801	šedá	chladno biela	280	15,70 €

NEW

NEW



- montážna krabička súčastí dodávky
- nevymentiteľný zdroj svetla

## GORDO DL-LED14

Nájazdové svetidlo LED

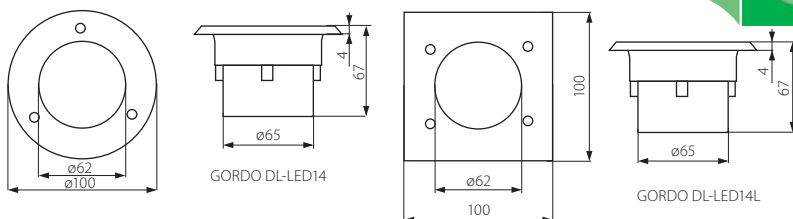

GORDO DL-LED14

GORDO DL-LED14L



■ GORDO DL-LED14

■ GORDO DL-LED14L



■ teleso: výlisok z oceľového plechu / okienko: kalené sklo / želný panel: koróziivzdorná oceľ

<b>Kanlux</b>	<b>Kanlux</b>	EAN			[g]	DKC SK bez DPH
GORDO DL-LED14	07010	5905339070104	matný chróm	biela	370	26,06 €
GORDO DL-LED14L	07012	5905339070128	matný chróm	chladno biela	440	26,06 €

NEW



- montážna krabička súčastí dodávky

# MORO DL-35



Nájzdové svetidlo

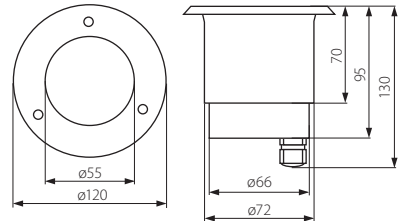
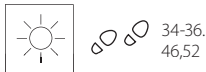

■ MORO DL-35

■ teleso svetidla: hliníková zliatina / difúzor: tvrdené sklo / čelný panel: nerezová oceľ

<b>Kanlux</b>		EAN 		DKC SK bez DPH
MORO DL-35	04870	5905339048707	matný chróm	24,90 €

230V~	50Hz	max 35	JDR	GU10/GZ10		[°]	[mm²] 3 x 1,5	IP 67	IK [J] 06	2000 kg 20[kN]				1/-/10	460	
-------	------	--------	-----	-----------	--	-----	------------------	-------	--------------	-------------------	--	--	--	--------	-----	--

- montážna krabička súčasťou dodávky
- ku svetidlu je doporučený prívodový kábel o priemeru max. 5,5 mm

# BERG DL-35

Nájzdové svetidlo



■ BERG DL-350



■ BERG DL-35L

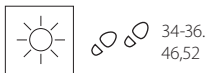

BERG DL-350

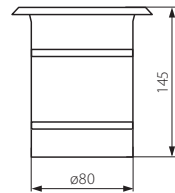
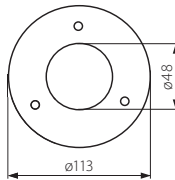

BERG DL-35L

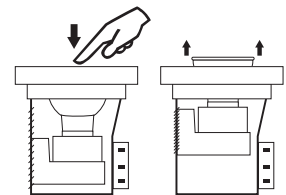
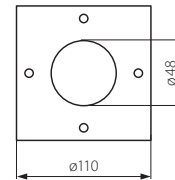

■ teleso: výlisok z oceľového plechu / okienko: kalené sklo / čelný panel: koróziuvzdorná oceľ

<b>Kanlux</b>		EAN 		[g]	DKC SK bez DPH
BERG DL-350	07170	5905339071705	matný chróm	720	29,55 €
BERG DL-35L	07171	5905339071712	matný chróm	810	29,55 €

230V~	max 35	JDR	GU10		[°]	[mm²] 3 x 2,5	[m]	IP 67	IK [J] 06	2000 kg 20[kN]				1/-/20	
-------	--------	-----	------	--	-----	------------------	-----	-------	--------------	-------------------	--	--	--	--------	--

- montážna krabička súčasťou dodávky
- možnosť priebežného propojenia
- ľahká výmena svetelného zdroja

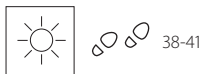
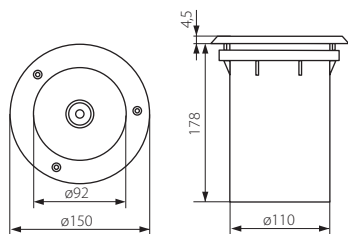

■ XARD DL-40

- teleso: lakovaný hliníkový odliatok / čelný panel: nerezová oceľ / sklo: tvrdené sklo / montážna krabica: plast

		EAN 		DKC SK bez DPH
XARD DL-40	07195	5905339071958	matný chróm	35,85 €



- montážna krabička súčasťou dodávky
- celková dĺžka svetelného zdroja 110mm

TURO MTH-70  
TURO MTH-150

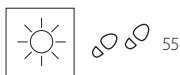
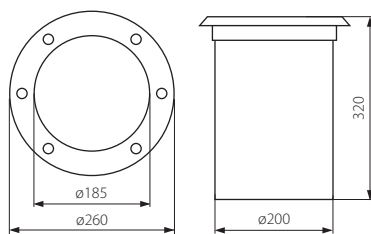

■ TURO MTH-70

Nájzdové svetidlo metalhalogenové

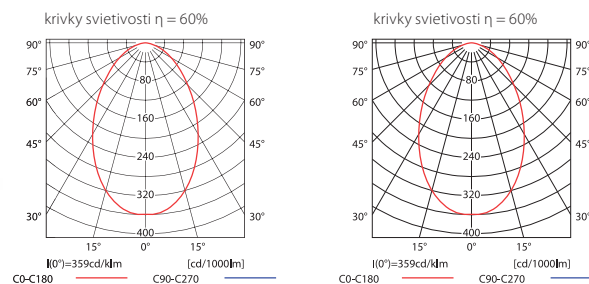

■ TURO MTH-70

■ TURO MTH-150

- teleso: hliníková zliatina / reflektor: hliník / difúzor: tvrdené sklo

		EAN 				DKC SK bez DPH
TURO MTH-70	04980	5905339049803	matný chróm	70	5600	77,41 €
TURO MTH-150	04981	5905339049810	matný chróm	150	6500	83,42 €

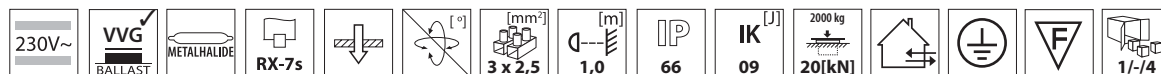

- montážna krabička súčasťou dodávky
- možnosť priebežného propojenia

Svietidlo typu „downlight“

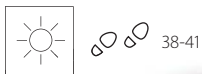

NIKOR DLP-60 - ø113  
NIKOR DLP-75 - ø146

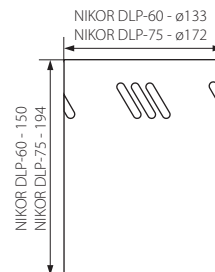

■ NIKOR DLP-60-W



■ NIKOR DLP-75-W

■ teleso svietidla: oceľový plech / reflektor: hliník

		EAN 		[W] 		[g] 	DKC SK bez DPH
NIKOR DLP-60-W	07210	5905339072108	biela	max 60	1/-/20	510	8,56 €
NIKOR DLP-75-W	07211	5905339072115	biela	max 75	1/-/12	865	11,77 €

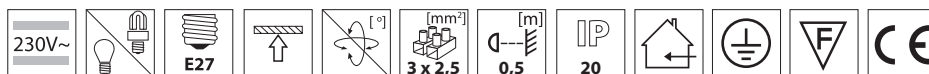

# MAYOR DLP-226-W

Svietidlo typu „downlight“

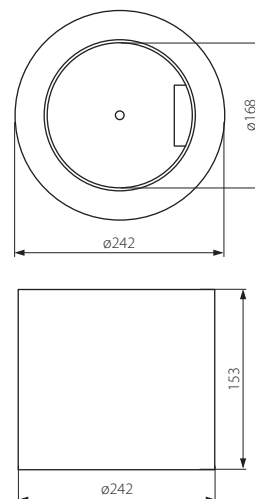
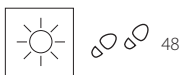

■ MAYOR DLP-226-W

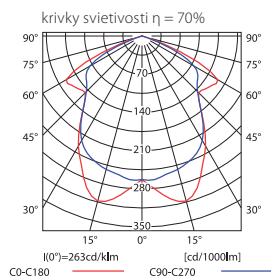

■ teleso svietidla: oceľový plech / reflektor: hliník

		EAN 		DKC SK bez DPH
MAYOR DLP-226-W	04942	5905339049421	biela	31,14 €

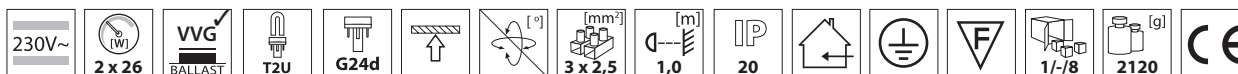



Svietidlo typu „downlight“

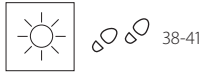
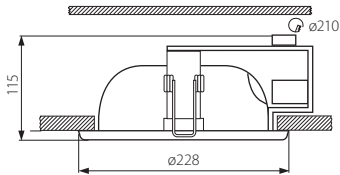

teleso svetidla: oceľový plech / límeč a reflektor: hliník / difúzor: tvrdené sklo

		EAN 		DKC SK bez DPH											
RALF DL-220-W	04820	5905339048202	biela	11,92 €											



Svietidlo typu „downlight“

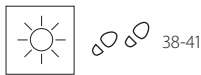
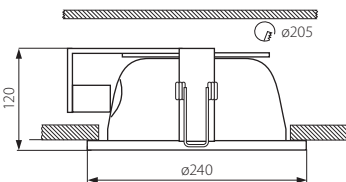

VARIO DL-220-W

teleso svetidla: oceľový plech / límeč a reflektor: hliník

		EAN 		DKC SK bez DPH											
VARIO DL-220-W	04821	5905339048219	biela	12,58 €											

# BEN DL-220-W



Svietidlo typu „downlight“

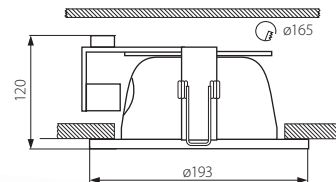
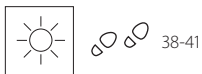

■ BEN DL-220-W

■ teleso svietidla: oceľový plech / límeč a reflektor: hliník

<b>Kanlux</b>	<b>Kanlux</b>	EAN 5905339048226	biela	DKC SK bez DPH 7,73 €
BEN DL-220-W	04822			

230V~	2 x max 20	COMPACT	E27	3 x 2,5	0,5	IP 20				1/-/12	590 [g]	
-------	------------	---------	-----	---------	-----	-------	--	--	--	--------	---------	--

# ASTON DLP-100

Svietidlo typu „downlight“

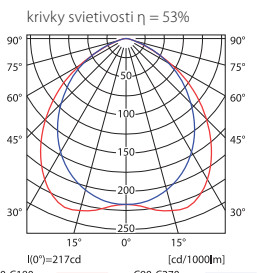
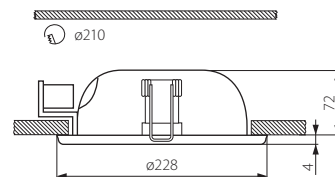
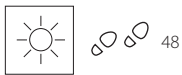

■ ASTON DLP-100 218-WH

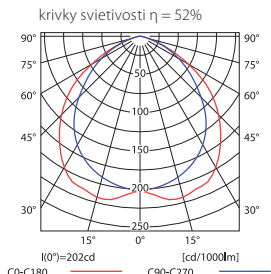

■ ASTON DLP-100 226-WH

■ teleso svietidla: oceľový plech / límeč a reflektor: hliník / difúzor: tvrdené sklo



■ ASTON DLP-100 226-WH



■ ASTON DLP-100 218-WH

<b>Kanlux</b>	<b>Kanlux</b>	EAN 5905339043405 5905339043412	biela	[W] 2 x 18 2 x 26	[g] 1460 1880	DKC SK bez DPH 27,39 € 28,87 €
ASTON DLP-100 218-WH	04340					
ASTON DLP-100 226-WH	04341					

230V~	VVG BALLAST	T2U	G24d	3 x 2,5	0,5	IP 20				1/-/10	
-------	-------------	-----	------	---------	-----	-------	--	--	--	--------	--

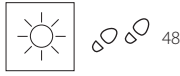
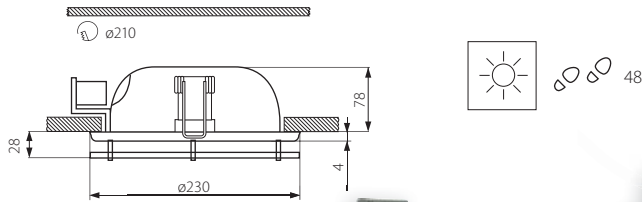

■ SLOT DLP-100G 218-WH



■ SLOT DLP-100G 226-WH

Svietidlo typu „downlight“

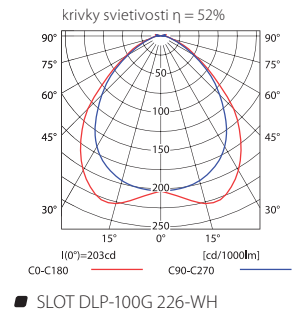
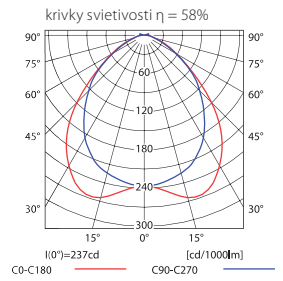

■ teleso svetidla: oceľový plech / límeček a reflektor: hliník / difúzor: tvrdené sklo

		EAN 				DKC SK bez DPH
SLOT DLP-100G 218-WH	04350	5905339043504	biela	2 x 18	1650	31,20 €
SLOT DLP-100G 226-WH	04351	5905339043511	biela	2 x 26	2070	32,70 €

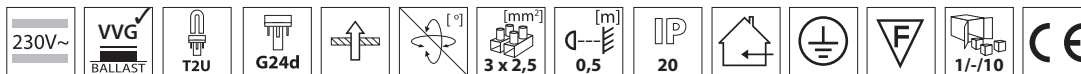

## NAZAR DLP-200 226-WH

Svietidlo typu „downlight“

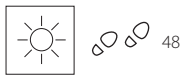
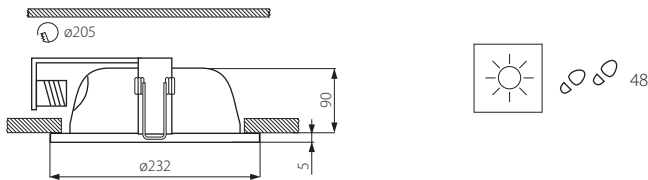

■ NAZAR DLP-200 226-WH

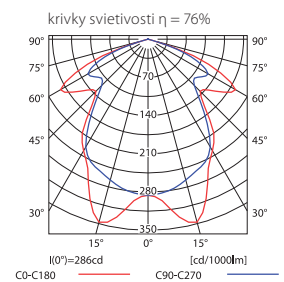

■ teleso svetidla: oceľový plech / límeček a reflektor: hliník

		EAN 		DKC SK bez DPH
NAZAR DLP-200 226-WH	04371	5905339043719	biela	27,85 €

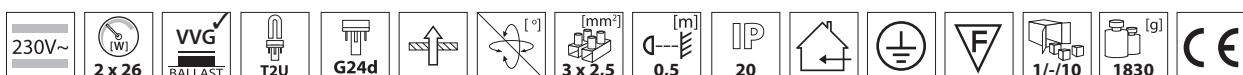

Svietidlo typu „downlight“

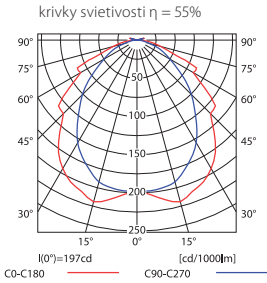
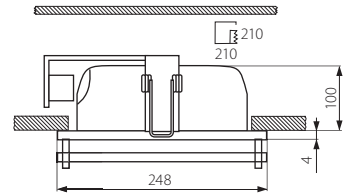
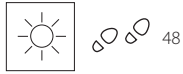

■ ANDES DLP-300G 226-WH

■ teleso svietidla: oceľový plech / límeč a reflektor: hliník / difúzor: tvrdené sklo

		EAN 		DKC SK bez DPH
ANDES DLP-300G 226-WH	04361	5905339043610	biela	35,78 €

230V~		VVG BALLAST	T2U	G24d			$3 \times 2,5$	$0,5$	IP 20					$1/-/6$		2820	CE
-------	--	-------------	-----	------	--	--	----------------	-------	-------	--	--	--	--	---------	--	------	----

## MATEO DLP

Svietidlo typu „downlight“

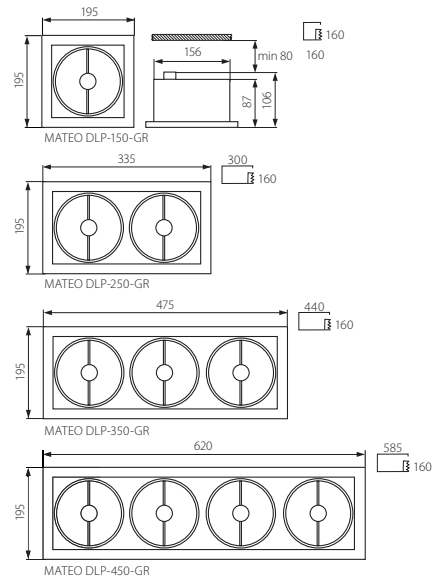
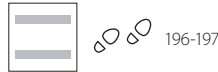

■ MATEO DLP-150-GR

■ MATEO DLP-250-GR

■ MATEO DLP-350-GR

■ MATEO DLP-450-GR

■ teleso a lem: oceľový plech / reflektor: hliník

		EAN 					DKC SK bez DPH
MATEO DLP-150-GR	04960	5905339049605	šedá	max 50	1/-/12	805	23,73 €
MATEO DLP-250-GR	04961	5905339049612	šedá	2 x max 50	1/-/6	1270	42,72 €
MATEO DLP-350-GR	04962	5905339049629	šedá	3 x max 50	1/-/6	1720	62,57 €
MATEO DLP-450-GR	04963	5905339049636	šedá	4 x max 50	1/-/6	2240	79,83 €

12V	AR-111	G53		$45$	$60$		$2 \times 2,5$	$1,0$	IP 20				CE
-----	--------	-----	--	------	------	--	----------------	-------	-------	--	--	--	----



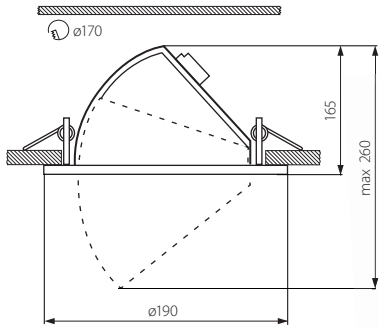

Svietidlo typu „downlight“

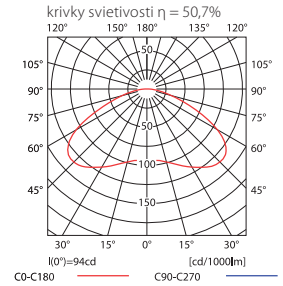

SELVA MTH-150-W

teleso: hliníková zliatina

<b>Kanlux</b>		EAN		DKC SK bez DPH
SELVA MTH-150-W	04905	5905339049056	biela	26,06 €

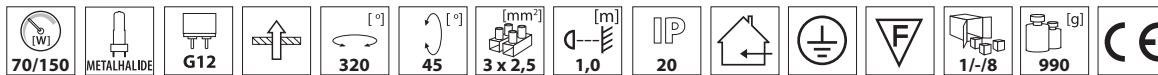

pre správnu činnosť svetidla je potrebný predradník, ktorý nájdete i v ponuke Kanlux (PERU 70 a PERU 150W)

## BRAVA MTH

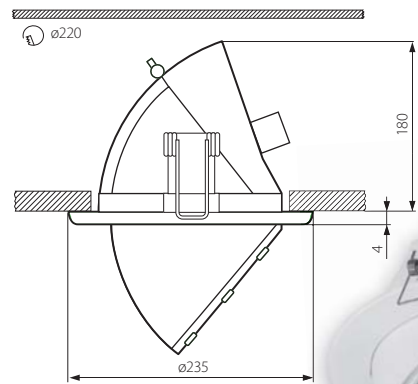

BRAVA MTH-70-W

BRAVA MTH-150-W

Svietidlo typu „downlight“

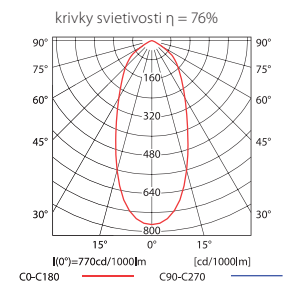

BRAVA MTH-70-W

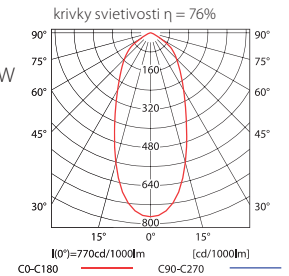

BRAVA MTH-150-W

teleso: hliníková zliatina / reflektor: hliník / difúzor: tvrdené sklo

<b>Kanlux</b>		EAN		[W]	DKC SK bez DPH
BRAVA MTH-70-W	04900	5905339049001	biela	70	38,80 €
BRAVA MTH-150-W	04901	5905339049018	biela	150	38,80 €



pre správnu činnosť svetidla je potrebný predradník, ktorý nájdete i v ponuke Kanlux (PERU 70/150W a GANA 70/150W)

Svietidlo typu „downlight“



55



199

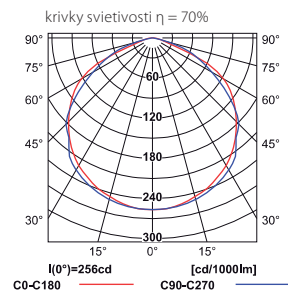
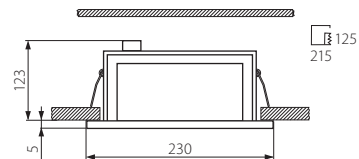

■ PASAT 70-C/M



■ PASAT 70-C/M  
■ PASAT 150-C/M

■ teleso svietidla: oceľový plech / límeč a reflektor: hliník / difúzor: tvrdené sklo

<b>Kanlux</b>	<b>Kanlux</b>	EAN			DKC SK bez DPH
PASAT 70-C/M	04310	5905339043108	matný chróm	70	24,86 €
PASAT 150-C/M	04315	5905339043153	matný chróm	150	24,86 €

■ pre správnu činnosť svietidla je potrebný predradník, ktorý nájdete i v ponuke Kanlux (PERU 70/150W a GANA 70/150W)

## MEDIA MTH

Metalhalogenidový reflektor



55

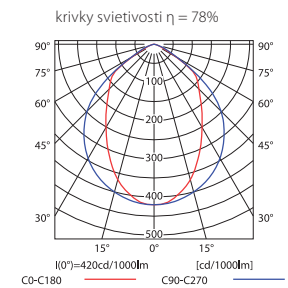

■ MEDIA MTH-70

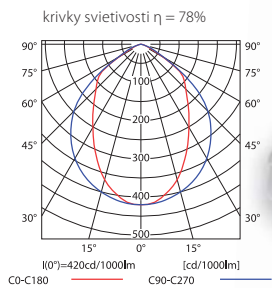

■ MEDIA MTH-150



■ MEDIA MTH-70-GR  
■ MEDIA MTH-150-GR

■ MEDIA MTH-70-W  
■ MEDIA MTH-150-W

■ teleso: hliníková zliatina / reflektor: hliník / difúzor: tvrdené sklo

<b>Kanlux</b>	<b>Kanlux</b>	EAN				DKC SK bez DPH
MEDIA MTH-70-W	04908	5905339049087	biela	70	3240	77,67 €
NEW MEDIA MTH-70-GR	04910	5905339049100	šedá	70	3240	77,67 €
MEDIA MTH-150-W	04909	5905339049094	biela	150	4010	81,99 €
NEW MEDIA MTH-150-GR	04911	5905339049117	šedá	150	4010	81,99 €

■ kompenzácia účinníka  
■ prúd výbojky 70W - 1A, 150W - 1,8A

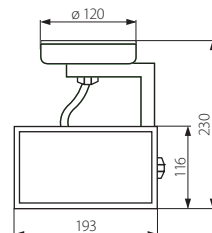
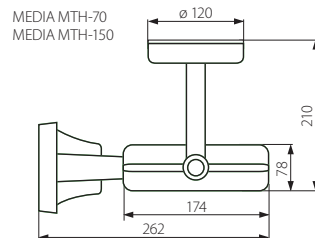

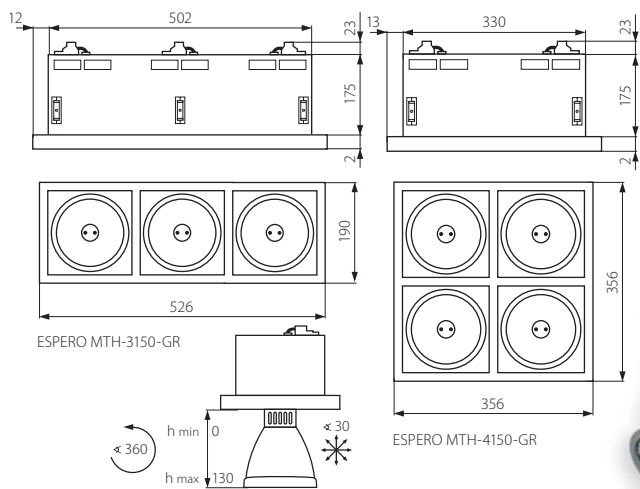

Halogenidové svetidlo

teleso svetidla a límeč: oceľový plech / reflektor svetidla hliník / difúzor: tvrdené sklo

	<b>Kanlux</b>	<b>Kanlux</b>	EAN			[g]	DKC SK bez DPH
<b>NEW</b>	ESPERO MTH-1150-GR	07490	5905339074904	šedá	1/-/8	1780	40,79 €
<b>NEW</b>	ESPERO MTH-2150-GR	07491	5905339074911	šedá	1/-/4	3110	73,11 €
<b>NEW</b>	ESPERO MTH-3150-GR	07492	5905339074928	šedá	1/-/4	4450	106,40 €
<b>NEW</b>	ESPERO MTH-4150-GR	07493	5905339074935	šedá	1/-/4	5700	133,11 €

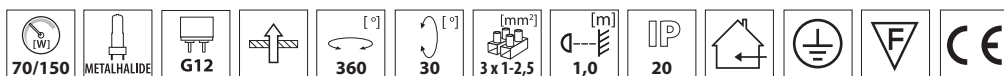

svietidlo s možnosťou smerového usmernenia svetelného toku  
pre správnu činnosť svetidla je potrebný predradník, ktorý nájdete i v ponuke Kanlux (PERU 70/150W a GANA 70/150W)

ESPERO MTH-2150-GR

## EURO MTH PC

Metalhalogenidové svetidlo

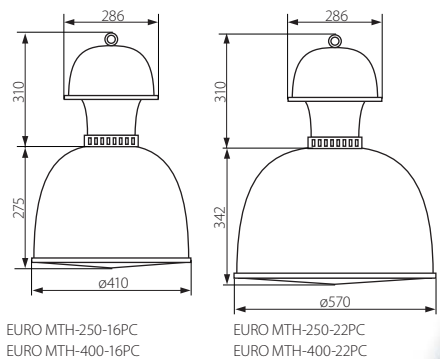

EURO MTH-250-16PC  
EURO MTH-400-16PC



EURO MTH-250-22PC  
EURO MTH-400-22PC

difúzor: PC / ochranné sklo: PC / starter: teleso-hliník

	<b>Kanlux</b>	<b>Kanlux</b>		[W]	[g]	DKC SK bez DPH
<b>NEW</b>	EURO MTH-250-16PC	07860	šedá	250	5885	95,33 €
<b>NEW</b>	EURO MTH-400-16PC	07861	šedá	400	6385	102,00 €
<b>NEW</b>	EURO MTH-250-22PC	07862	šedá	250	7390	102,00 €
<b>NEW</b>	EURO MTH-400-22PC	07863	šedá	400	7890	108,67 €

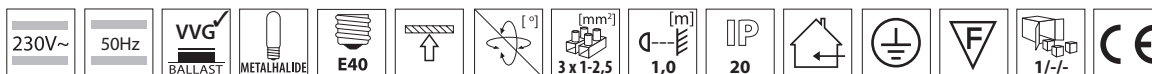

prúd výbojky 250W - 2,1A, 400W - 3,5A

Metalhalogenidové svietidlo



- EURO MTH-250-21AL
- EURO MTH-400-21AL

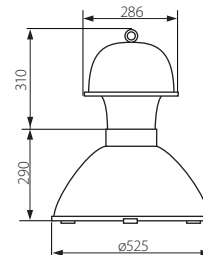

■ difúzor: hliník / ochranné sklo: tvrdené sklo / starter: teleso-hliník

						DKC SK bez DPH
<b>NEW</b>	EURO MTH-250-21AL	07864	šedá	250	7780	115,33 €
<b>NEW</b>	EURO MTH-400-21AL	07865	šedá	400	8280	122,00 €

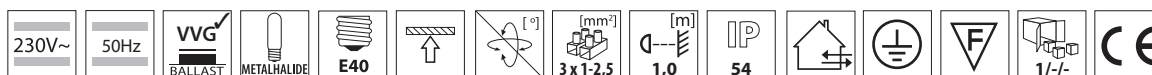

■ prúd výbojky 250W - 2,1A, 400W - 3,5A

# ENEAL-17A-SR

Nástenné svietidlo určené k montáži na lištu

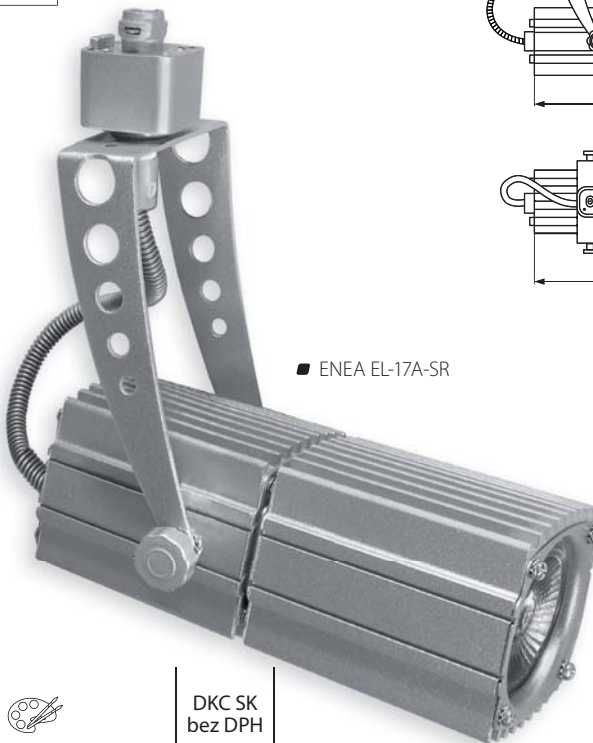

■ ENEAL-17A-SR

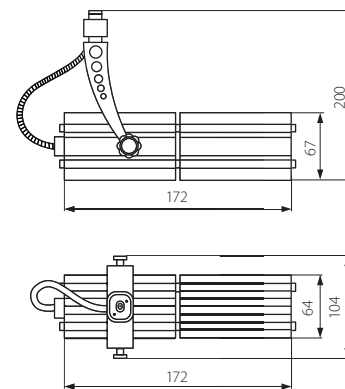

■ teleso: hliník / držiak: oceľový plech

			EAN		DKC SK bez DPH
<b>NEW</b>	ENEAL-17A-SR	07530	5905339075307	strieborná	21,56 €

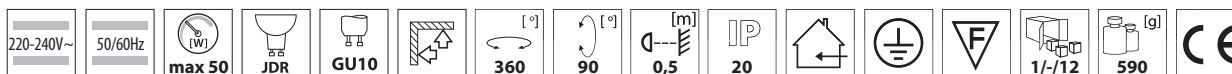

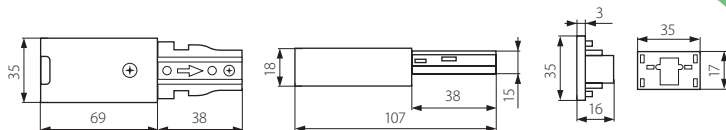

Montážna krabica so zaslepovaciou zátkou



■ ENEA PR

■ těleso: umelá hmota

<b>NEW</b>			EAN 		DKC SK bez DPH
ENE A PR	07533	5905339075338	strieborná	2,20 €	

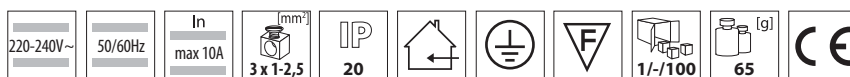

■ slúži k zapojeniu prívodu do kolejovej svorkovnice, alebo k zaslepeniu voľného konca svorkovnice

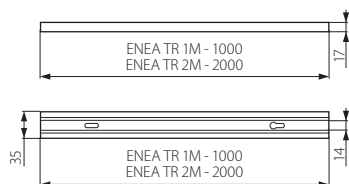

Koľajnicové vedenie



- ENEA TR 1M
- ENEA TR 2M



■ těleso: hliníková zliatina

<b>NEW</b>			EAN 			DKC SK bez DPH
ENE A TR 1M	07531	5905339075314	strieborná	500	8,57 €	
ENE A TR 2M	07532	5905339075321	strieborná	1000	17,56 €	



■ určená pre montáž svietidiel zo série ENEA EL

# MATMA MTH

**Kanlux**

Metalhalogenidový reflektor



55

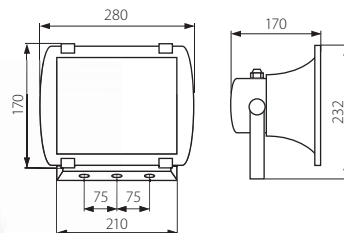

- MATMA MTH-70
- MATMA MTH-150

krivky svietivosti  $\eta = 76\%$

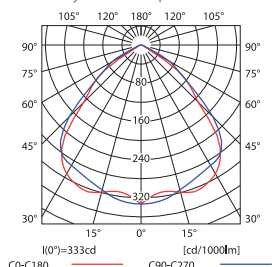

■ MATMA MTH-70

krivky svietivosti  $\eta = 76\%$

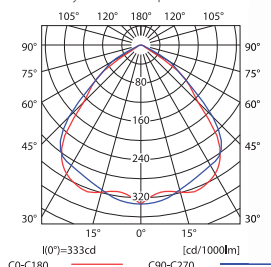

■ MATMA MTH-150

■ teleso svetidla a reflektor: hliník / difúzor: sklo

		EAN 		[W]	[g]	DKC SK bez DPH
MATMA MTH-70	04815	5905339048158	čierna	70	3500	50,62 €
MATMA MTH-150	04816	5905339048165	čierna	150	4200	58,79 €

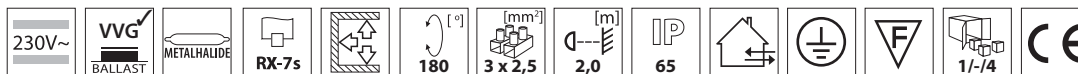

■ prúd výbojky 70W - 1A, 150W - 1,8A

# REVA MTH

Metalhalogenidový reflektor



55

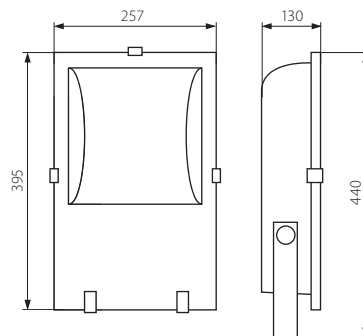

- REVA MTH-70/S
- REVA MTH-150/S

krivky svietivosti  $\eta = 71\%$

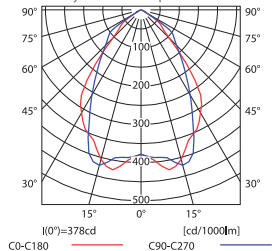

■ REVA MTH-70/S

krivky svietivosti  $\eta = 71\%$

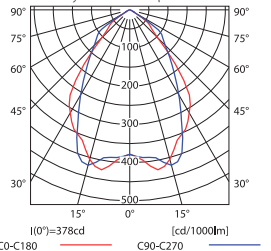

■ REVA MTH-150/S

■ teleso svetidla a reflektor: hliník / difúzor: sklo

		EAN 		[W]	[g]	DKC SK bez DPH
REVA MTH-70/S	04835	5905339048356	čierna	70	5100	78,47 €
REVA MTH-150/S	04838	5905339048387	čierna	150	5800	87,17 €

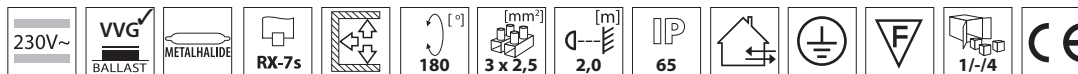

■ prúd výbojky 70W - 1A, 150W - 1,8A

Metalhalogenidový reflektor

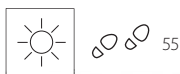
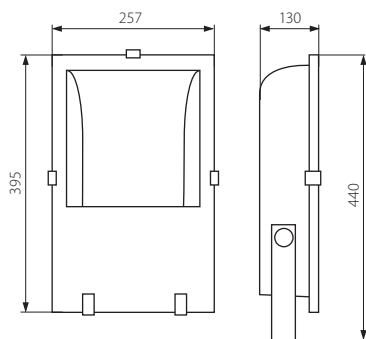

- REVA MTH-70/A
- REVA MTH-150/A

krivky svetivosti  $\eta = 64\%$

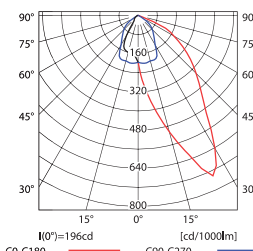

■ REVA MTH-70/A

krivky svetivosti  $\eta = 64\%$

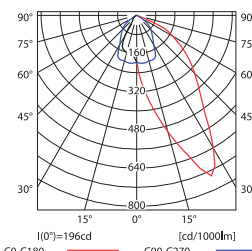

■ REVA MTH-150/A

■ teleso svetidla a reflektor: hliník / difúzor: sklo

<b>Kanlux</b>	<b>Kanlux</b>	EAN		[W]	[g]	DKC SK bez DPH
REVA MTH-70/A	04836	5905339048363	čierna	70	5100	78,47 €
REVA MTH-150/A	04839	5905339048394	čierna	150	5800	87,17 €

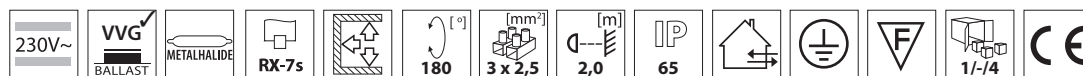

■ prúd výbojky 70W - 1A, 150W - 1,8A

## FORT MTH-473

Metalhalogenidový reflektor

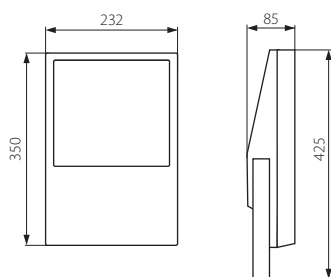

- FORT MTH-473/70W-B
- FORT MTH-473/150W-B

krivky svetivosti  $\eta = 60\%$

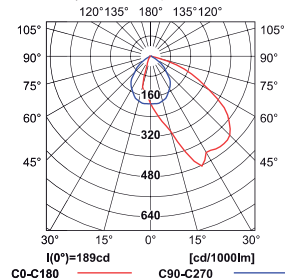

■ FORT MTH-473/70W-B

krivky svetivosti  $\eta = 60\%$

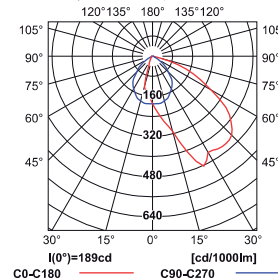

■ FORT MTH-473/150W-B

■ teleso svetidla a reflektor: hliník / difúzor: sklo

<b>Kanlux</b>	<b>Kanlux</b>	EAN		[W]	[g]	DKC SK bez DPH
FORT MTH-473/70W-B	04012	5905339040121	čierna	70	3800	59,72 €
FORT MTH-473/150W-B	04010	5905339040107	čierna	150	4600	64,10 €

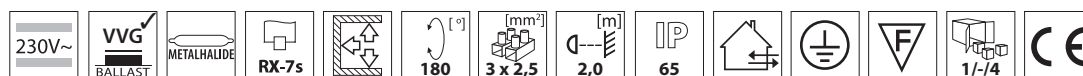

■ prúd výbojky 70W - 1A, 150W - 1,8A

Metalhalogenidový reflektor



55

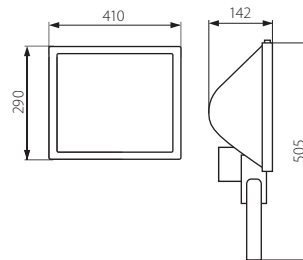

- AVIA MTH-478/250W-B
- AVIA MTH-478/400W-B

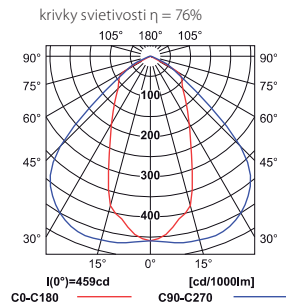
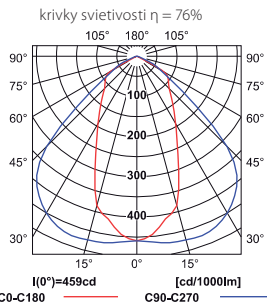

- AVIA MTH-478/250W-B
- AVIA MTH-478/400W-B

■ teleso svetidla a reflektor: hliník / difúzor: sklo

		EAN 				DKC SK bez DPH
AVIA MTH-478/250W-B	04013	5905339040138	čierna	250	6500	77,67 €
AVIA MTH-478/400W-B	04011	5905339040114	čierna	400	7300	85,37 €

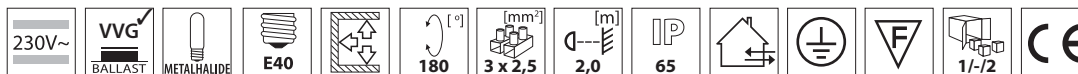

■ prúd výbojky 250W - 2,1A, 400W - 3,5A

# ADAMO MTH

Metalhalogenidový reflektor



55

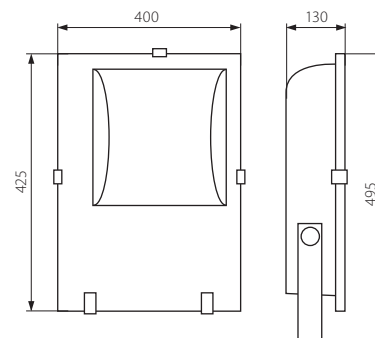

- ADAMO MTH-250/S
- ADAMO MTH-400/S

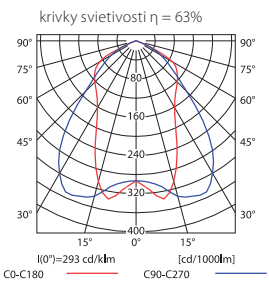
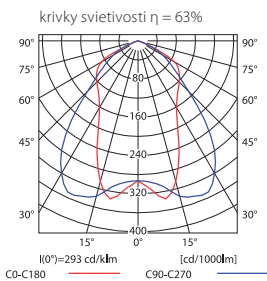

- ADAMO MTH-250/S
- ADAMO MTH-400/S

■ teleso svetidla a reflektor: hliník / difúzor: sklo

		EAN 				DKC SK bez DPH
ADAMO MTH-250/S	04841	5905339048417	čierna	250	7800	105,86 €
ADAMO MTH-400/S	04842	5905339048424	čierna	400	8500	112,10 €

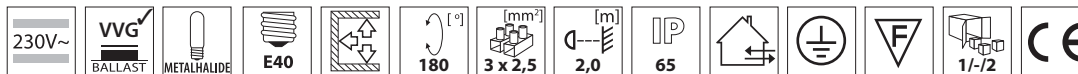

■ prúd výbojky 250W - 2,1A, 400W - 3,5A



Metalhalogenidový reflektor

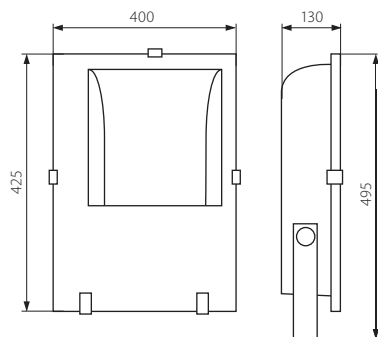

- ADAMO MTH-250/A
- ADAMO MTH-400/A

krivky svetivosti  $\eta = 65\%$

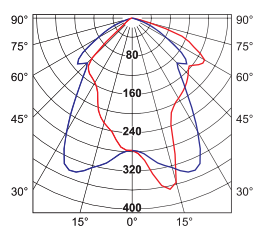

■ ADAMO MTH-250/A

krivky svetivosti  $\eta = 65\%$

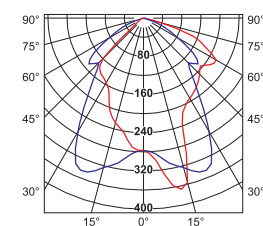

■ ADAMO MTH-400/A

■ teleso svetidla a reflektor: hliník / difúzor: sklo

		EAN				DKC SK bez DPH
ADAMO MTH-250/A	04845	5905339048455	čierna	250	7800	105,86 €
ADAMO MTH-400/A	04846	5905339048462	čierna	400	8500	112,10 €

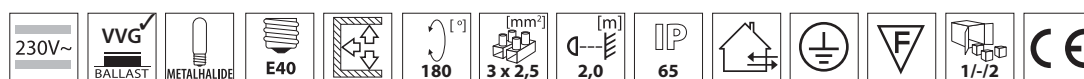

■ prúd výbojky 250W - 2,1A, 400W - 3,5A

LED reflektor

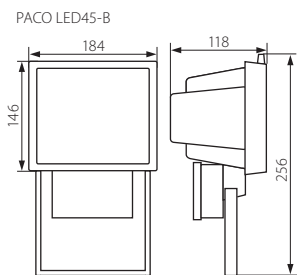
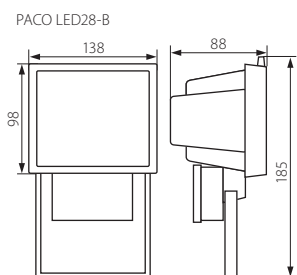

■ PACO LED45-B



■ PACO LED28-B

■ teleso svetidla a reflektor: hliník / difúzor: sklo

		EAN						DKC SK bez DPH	
<b>NEW</b> PACO LED28-B	07620	5905339076205	čierna	max 2	28 ✓	biela	1/-/30	390	11,11 €
<b>NEW</b> PACO LED45-B	07610	5905339076106	čierna	max 4	45 ✓	biela	1/-/12	815	17,78 €

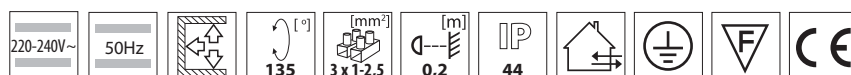

# BRUNO EL-20-B

**Kanlux**

Projekčné žiarivkové svetidlo



38-41

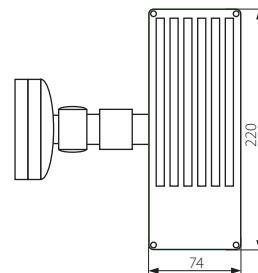
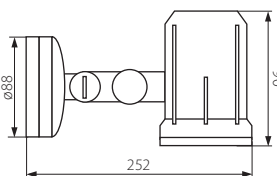

■ BRUNO EL-20-B

■ teleso svetidla: plast / reflektor: hliník

		EAN 		DKC SK bez DPH
BRUNO EL-20-B	07215	5905339072153	čierna	11,12 €

220-240V~	50/60Hz	max 20				90	2 x 1,5	0,5	IP 44				1/-/16	480 [g]	
-----------	---------	--------	--	--	--	----	---------	-----	-------	--	--	--	--------	---------	--

# JEN CE-82-B BALTA

Žiarivkový reflektor



■ JEN CE-82-B BALTA

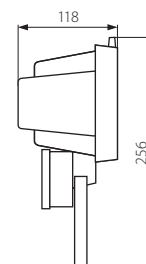
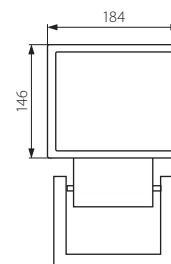

■ teleso svetidla a reflektor: hliník / difúzor: sklo

		EAN 		DKC SK bez DPH
<b>NEW</b> JEN CE-82-B BALTA	07460	5905339074607	čierna	12,85 €

230V~	50Hz	24				4000		90	3 x 1-2,5	0,5	IP 44				1/-/12	900 [g]	
-------	------	----	--	--	--	------	--	----	-----------	-----	-------	--	--	--	--------	---------	--

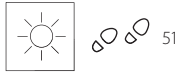
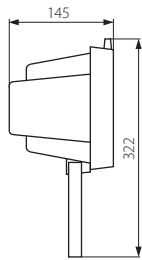
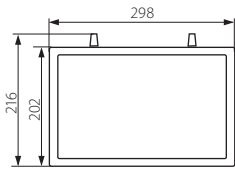

■ LOMA 1000-B

■ teleso svetidla a reflektor: hliník / difúzor: sklo

		EAN 		DKC SK bez DPH
LOMA 1000-B	04675	5905339046758	čierna	30,04 €

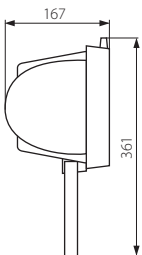
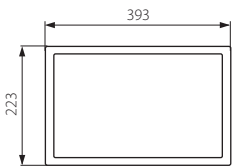

■ SALI 1500-B

■ teleso svetidla a reflektor: hliník / difúzor: sklo

		EAN 		DKC SK bez DPH
SALI 1500-B	04676	5905339046765	čierna	46,70 €

# MEX CE-81



Halogénový reflektor



■ MEX CE-81-W



45,51



■ MEX CE-81-B

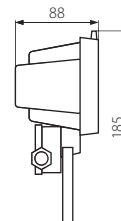
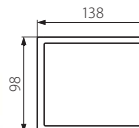

■ teleso svietidla a reflektor: hliník / difúzor: sklo

		EAN 		DKC SK bez DPH
MEX CE-81-W	00602	5905339006028	biela	4,32 €
MEX CE-81-B	00600	5905339006004	čierna	4,32 €

230V~	max150	J-78mm	R7s	90	3 x 2,5	1,0	IP 44				1-/30	395 [g]	
-------	--------	--------	-----	----	---------	-----	-------	--	--	--	-------	---------	--

# JEN CE-82

Halogénový reflektor



■ JEN CE-82-W



45,51



■ JEN CE-82-B

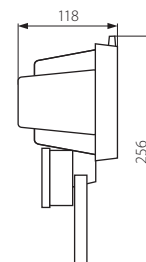
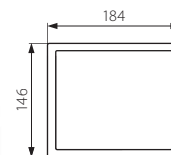

■ teleso svietidla a reflektor: hliník / difúzor: sklo

		EAN 		DKC SK bez DPH
JEN CE-82-W	00608	5905339006080	biela	5,81 €
JEN CE-82-B	00606	5905339006066	čierna	5,81 €

230V~	max 500	J-118mm	R7s	90	3 x 2,5	1,0	IP 44				1-/12	770 [g]	
-------	---------	---------	-----	----	---------	-----	-------	--	--	--	-------	---------	--

Halogénový reflektor

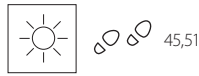
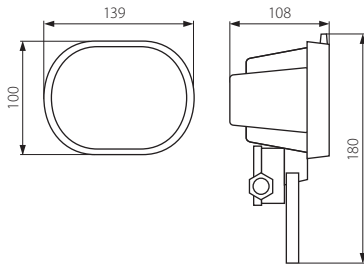

■ MEZO CE-81-Y-W



■ MEZO CE-81-Y-B

■ teleso svetidla a reflektor: hliník / difúzor: sklo

<b>Kanlux</b>		EAN 		DKC SK bez DPH
MEZO CE-81-Y-W	00665	5905339006653	biela	4,22 €
MEZO CE-81-Y-B	00664	5905339006646	čierna	4,22 €

230V~	max 150	J-78mm	R7s	90 [°]	3 x 2,5 [mm²]	1,0 [m]	IP 44				1/-/30	390 [g]	
-------	---------	--------	-----	--------	---------------	---------	-------	--	--	--	--------	---------	--

Halogénový reflektor

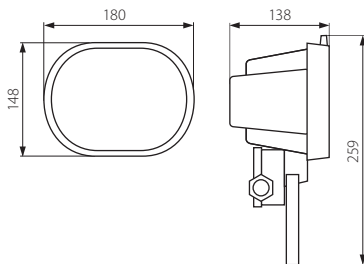

■ OTIS CE-82-Y-W



■ OTIS CE-82-Y-B

■ teleso svetidla a reflektor: hliník / difúzor: sklo

<b>Kanlux</b>		EAN 		DKC SK bez DPH
OTIS CE-82-Y-W	00675	5905339006752	biela	5,61 €
OTIS CE-82-Y-B	00674	5905339006745	čierna	5,61 €

  

230V~	max 500	J-118mm	R7s	90 [°]	3 x 2,5 [mm²]	1,0 [m]	IP 44				1/-/12	730 [g]	
-------	---------	---------	-----	--------	---------------	---------	-------	--	--	--	--------	---------	--

# FARE SL-150R-F



Halogénový reflektor

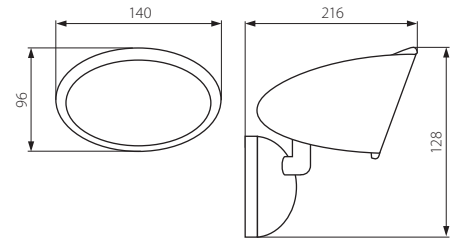
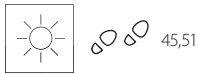

■ FARE SL-150R-F-W



■ FARE SL-150R-F-B

■ teleso svietidla a reflektor: hliník / difúzor: sklo

		EAN 		DKC SK bez DPH
FARE SL-150R-F-W	00681	5905339006813	biela	7,67 €
FARE SL-150R-F-B	00680	5905339006806	čierna	7,67 €

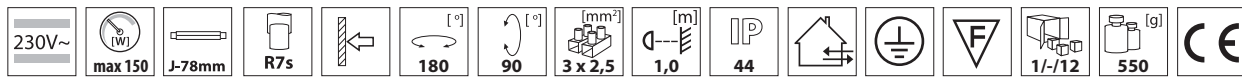

# EDIT SL-300R-F

Halogénový reflektor

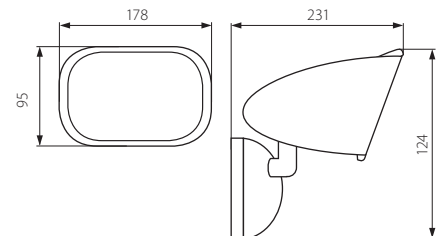
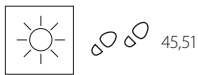

■ EDIT SL-300R-F-W



■ EDIT SL-300R-F-B

■ teleso svietidla a reflektor: hliník / difúzor: sklo

		EAN 		DKC SK bez DPH
EDIT SL-300R-F-W	00686	5905339006868	biela	8,53 €
EDIT SL-300R-F-B	00685	5905339006851	čierna	8,53 €

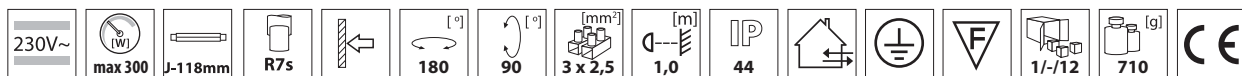

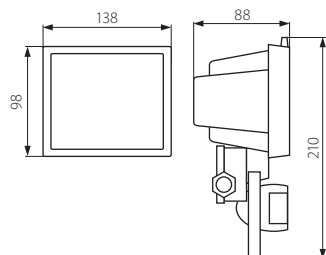

■ MEX CE-81PX-W



■ MEX CE-81PX-B

Halogénový reflektor s čidlom pohybu

■ teleso svetidla a reflektor: hliník / difúzor: sklo

		EAN 
MEX CE-81PX-W	00656	5905339006561
MEX CE-81PX-B	00655	5905339006554



biela  
čierna

DKC SK  
bez DPH

14,57 €  
14,57 €

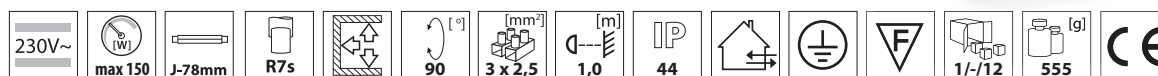

- rozsah vertikálneho nastavenia čidla pohybu 90°
- rozsah horizontálneho nastavenia čidla pohybu 180°
- dosah čidla pohybu do 12m
- maximálny rozsah čidla pohybu 180°
- možnosť regulácie doby svietenia v rozsahu od 5s do 12min
- možnosť nastavenia svetelnej intenzity, pri ktorej zariadenie pracuje

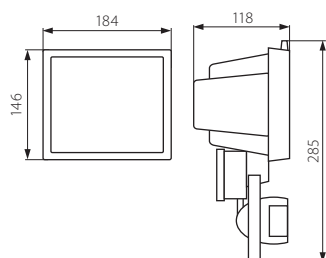

■ JEN CE-82PX-W



■ JEN CE-82PX-B

Halogénový reflektor s čidlom pohybu

■ teleso svetidla a reflektor: hliník / difúzor: sklo

		EAN 
JEN CE-82PX-W	00658	5905339006585
JEN CE-82PX-B	00657	5905339006578



biela  
čierna

DKC SK  
bez DPH

17,23 €  
17,23 €

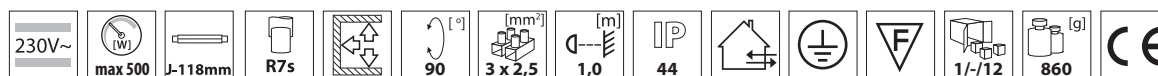

- rozsah vertikálneho nastavenia čidla pohybu 90°
- rozsah horizontálneho nastavenia čidla pohybu 180°
- dosah čidla pohybu do 12m
- maximálny rozsah čidla pohybu 180°
- možnosť regulácie doby svietenia v rozsahu od 5s do 12min
- možnosť nastavenia svetelnej intenzity, pri ktorej zariadenie pracuje

# MEZO CE-81P-Y

**Kanlux**

Halogénový reflektor s čidlom pohybu

MEZO CE-81P-Y-W



45,51



MEZO CE-81P-Y-B

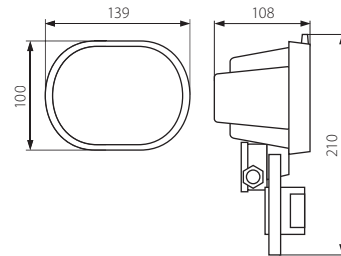

teleso svetidla a reflektor: hliník / difúzor: sklo

		EAN 		DKC SK bez DPH
MEZO CE-81P-Y-W	00667	5905339006677	biela	14,57 €
MEZO CE-81P-Y-B	00666	5905339006660	čierna	14,57 €

230V~	max 150	J-78mm	R7s	90	3 x 2,5	1,0	IP 44				1/-/12	550 [g]	
-------	---------	--------	-----	----	---------	-----	-------	--	--	--	--------	---------	--

- rozsah vertikálneho nastavenia čidla pohybu 90°
- rozsah horizontálneho nastavenia čidla pohybu 180°
- dosah čidla pohybu do 12m
- maximálny rozsah čidla pohybu 180°
- možnosť regulácie doby svietenia v rozsahu od 5s do 12min
- možnosť nastavenia svetelnej intenzity, pri ktorej zariadenie pracuje

# OTIS CE-82P-Y

Halogénový reflektor s čidlom pohybu

OTIS CE-82P-Y-B



45,51



OTIS CE-82P-Y-W

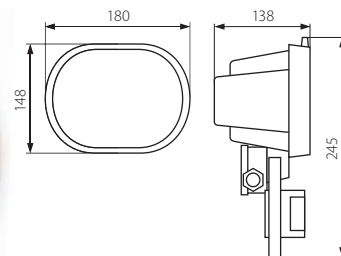

teleso svetidla a reflektor: hliník / difúzor: sklo

		EAN 		DKC SK bez DPH
OTIS CE-82P-Y-W	00677	5905339006776	biela	17,16 €
OTIS CE-82P-Y-B	00676	5905339006769	čierna	17,16 €

  

230V~	max 500	J-118mm	R7s	90	3 x 2,5	1,0	IP 44				1/-/12	810 [g]	
-------	---------	---------	-----	----	---------	-----	-------	--	--	--	--------	---------	--

- rozsah vertikálneho nastavenia čidla pohybu 90°
- rozsah horizontálneho nastavenia čidla pohybu 180°
- dosah čidla pohybu do 12m
- maximálny rozsah čidla pohybu 180°
- možnosť regulácie doby svietenia v rozsahu od 5s do 12min
- možnosť nastavenia svetelnej intenzity, pri ktorej zariadenie pracuje



Halogénový reflektor s čidlom pohybu

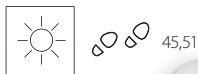
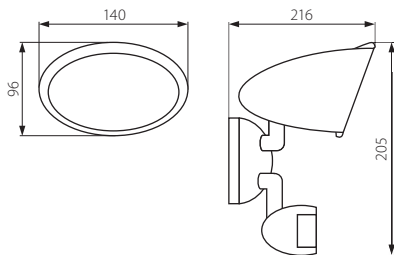

■ FARE SL-150R-P-W

■ FARE SL-150R-P-B

■ teleso svetidla a reflektor: hliník / difúzor: sklo

		EAN 		DKC SK bez DPH
FARE SL-150R-P-W	00683	5905339006837	biela	17,16 €
FARE SL-150R-P-B	00682	5905339006820	čierna	17,16 €

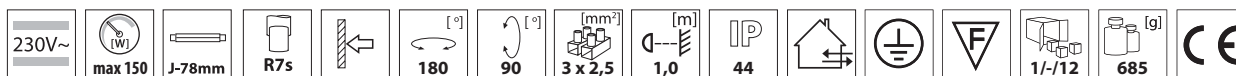

- rozsah vertikálneho nastavenia čidla pohybu 90°
- rozsah horizontálneho nastavenia čidla pohybu 180°
- dosah čidla pohybu do 12m
- maximálny rozsah čidla pohybu 180°
- možnosť regulácie doby svietenia v rozsahu od 5s do 12min
- možnosť nastavenia svetelnej intenzity, pri ktorej zariadenie pracuje

Halogénový reflektor s čidlom pohybu

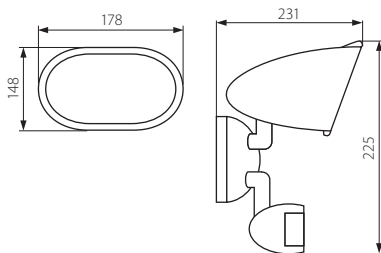

■ EDIT SL-300R-P-W

■ EDIT SL-300R-P-B

■ teleso svetidla a reflektor: hliník / difúzor: sklo

		EAN 		DKC SK bez DPH
EDIT SL-300R-P-W	00688	5905339006882	biela	18,12 €
EDIT SL-300R-P-B	00687	5905339006875	čierna	18,12 €

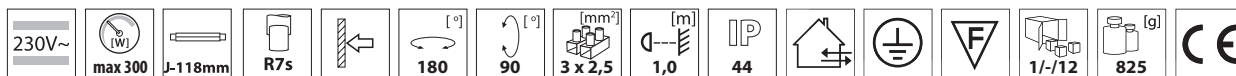

- rozsah vertikálneho nastavenia čidla pohybu 90°
- rozsah horizontálneho nastavenia čidla pohybu 180°
- dosah čidla pohybu do 12m
- maximálny rozsah čidla pohybu 180°
- možnosť regulácie doby svietenia v rozsahu od 5s do 12min
- možnosť nastavenia svetelnej intenzity, pri ktorej zariadenie pracuje

# TRAP ZW3-L150P-B

**Kanlux**

Prenosný halogénový reflektor

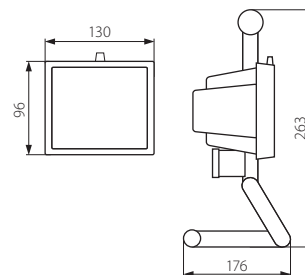
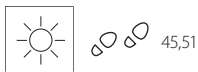

■ TRAP ZW3-L150P-B



■ teleso svetidla a reflektor: hliník / difúzor: sklo

		EAN 		DKC SK bez DPH
TRAP ZW3-L150P-B	00616	5905339006165	čierna	10,75 €

# ELIOT ZW3-L500P-B

Prenosný halogénový reflektor

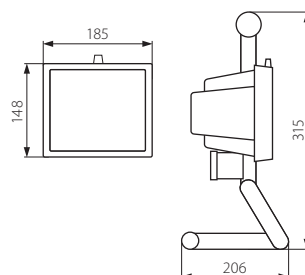

■ ELIOT ZW3-L500P-B



■ teleso svetidla a reflektor: hliník / difúzor: sklo

		EAN 		DKC SK bez DPH
ELIOT ZW3-L500P-B	00620	5905339006202	čierna	16,27 €

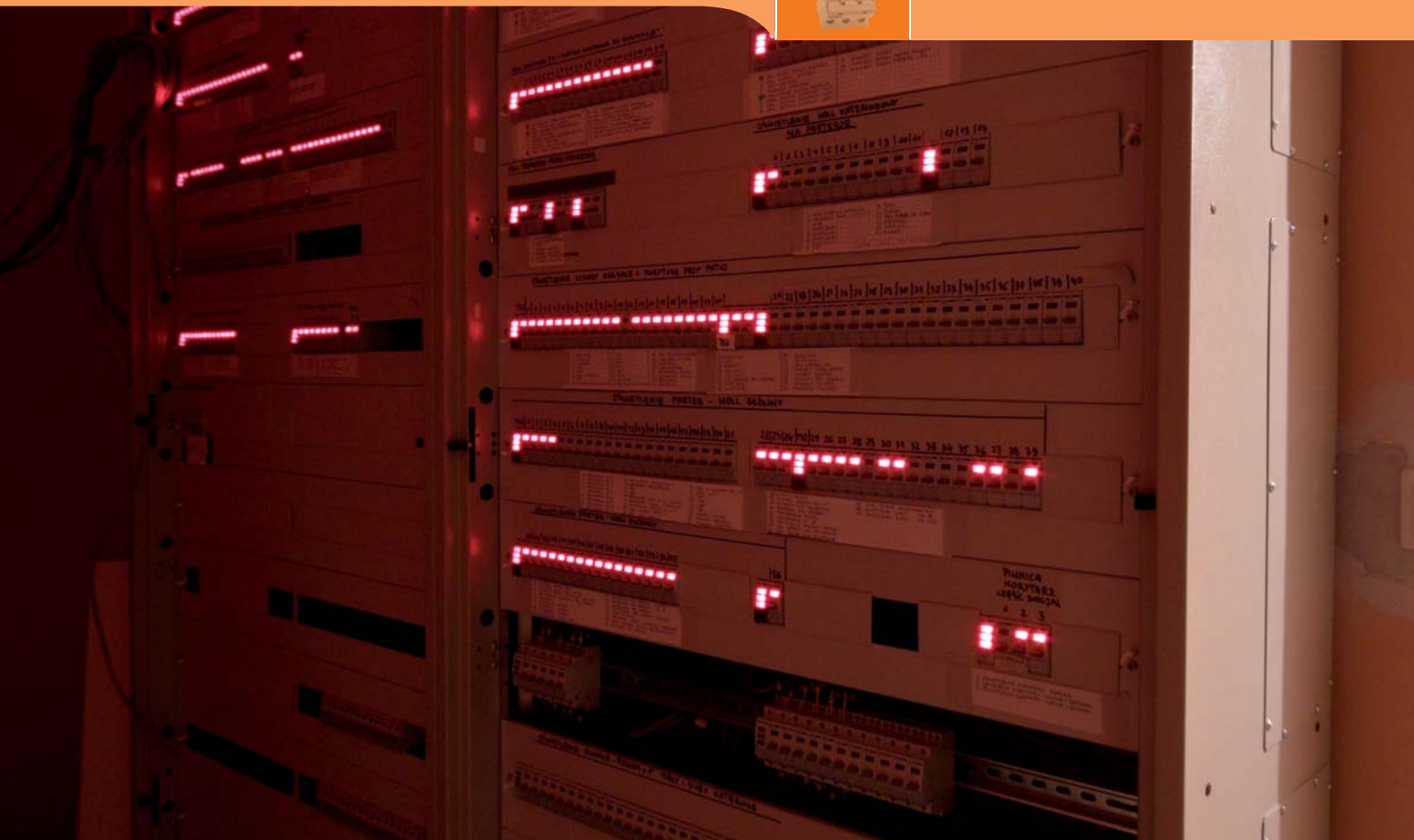

[www.kanlux.sk](http://www.kanlux.sk)

Istiaca technika

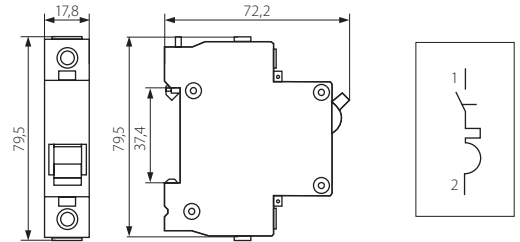

■ KS6 B25/1

Charakteristika prístroja

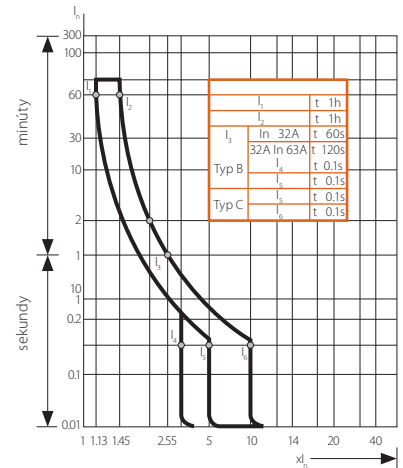

■ teleso: plast

Kanlux	Kanlux	EAN			In	DKC SK bez DPH
KS6 B1/1	04410	5905339044105	svetlo šedá	čierna	1A	4,08 €
KS6 B2/1	04411	5905339044112	svetlo šedá	ružová	2A	4,08 €
KS6 B4/1	04412	5905339044129	svetlo šedá	hnedá	4A	4,08 €
KS6 B6/1	04413	5905339044136	svetlo šedá	zelená	6A	3,95 €
KS6 B10/1	04414	5905339044143	svetlo šedá	červená	10A	3,58 €
KS6 B13/1	04415	5905339044150	svetlo šedá	béžová	13A	3,58 €
KS6 B16/1	04416	5905339044167	svetlo šedá	šedá	16A	3,58 €
KS6 B20/1	04417	5905339044174	svetlo šedá	modrá	20A	3,85 €
KS6 B25/1	04418	5905339044181	svetlo šedá	žltá	25A	4,08 €
KS6 B32/1	04419	5905339044198	svetlo šedá	fialová	32A	4,08 €
KS6 B40/1	04420	5905339044204	svetlo šedá	čierna	40A	4,28 €

■ slúži k ochrane elektrických obvodov a spotrebičov pred účinkami preťaženia a skratom  
 ■ zhoda s normami EN60898/IEC60898

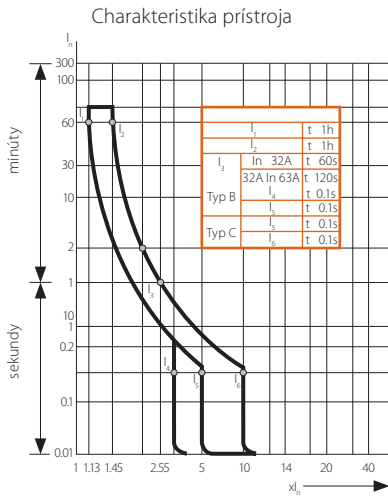
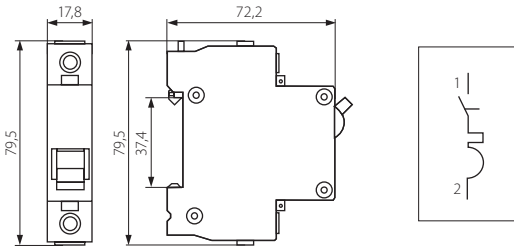

■ KS6 C10/1

■ teleso: plast

Kanlux	Kanlux	EAN			In	DKC SK bez DPH
KS6 C2/1	04431	5905339044310	svetlo šedá	ružová	2A	4,28 €
KS6 C4/1	04432	5905339044327	svetlo šedá	hnedá	4A	4,28 €
KS6 C6/1	04433	5905339044334	svetlo šedá	zelená	6A	4,08 €
KS6 C10/1	04434	5905339044341	svetlo šedá	červená	10A	3,95 €
KS6 C16/1	04435	5905339044358	svetlo šedá	šedá	16A	3,95 €
KS6 C20/1	04436	5905339044365	svetlo šedá	modrá	20A	3,95 €
KS6 C25/1	04437	5905339044372	svetlo šedá	žltá	25A	4,28 €
KS6 C32/1	04438	5905339044389	svetlo šedá	fialová	32A	4,58 €
KS6 C40/1	04439	5905339044396	svetlo šedá	čierna	40A	4,58 €

Un 230/400V~	50 Hz	Icn 6000A					IP 20			-5÷40					
-----------------	-------	--------------	--	--	--	--	----------	--	--	-------	--	--	--	--	--

■ slúži k ochrane elektrických obvodov a spotrebičov pred účinkami preťaženia a skratom v obvodoch s prúdovými rázmi  
 ■ zhoda s normami EN60898/IEC60898

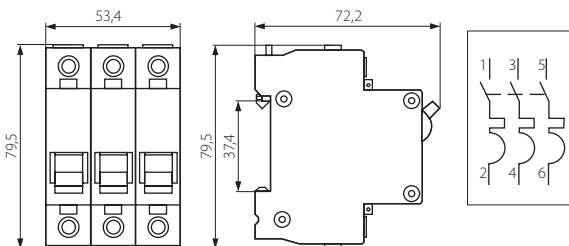

■ KS6 B20/3

Charakteristika prístroja

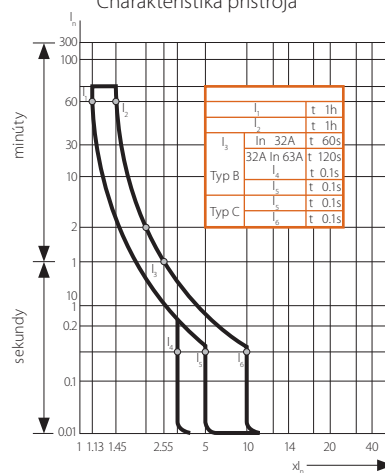

■ teleso: plast

Kanlux	Kanlux	EAN			In	DKC SK bez DPH
KS6 B6/3	04450	5905339044501	svetlo šedá	zelená	6A	10,69 €
KS6 B10/3	04451	5905339044518	svetlo šedá	červená	10A	10,69 €
KS6 B16/3	04452	5905339044525	svetlo šedá	šedá	16A	10,69 €
KS6 B20/3	04453	5905339044532	svetlo šedá	modrá	20A	11,75 €
KS6 B25/3	04454	5905339044549	svetlo šedá	žltá	25A	13,18 €
KS6 B32/3	04455	5905339044556	svetlo šedá	fialová	32A	14,24 €
KS6 B40/3	04456	5905339044563	svetlo šedá	čierna	40A	14,61 €
KS6 B50/3	04457	5905339044570	svetlo šedá	čierna	50A	15,00 €
KS6 B63/3	04458	5905339044587	svetlo šedá	čierna	63A	15,37 €

Un 400V~
50 Hz
Icn 6000A
B
DIN 35mm
4000
1÷25
IP 20
-5÷40
3P
-/4/40
325
CE

■ slúži k ochrane elektrických obvodov a spotrebičov pred účinkami preťaženia a skratom  
 ■ zhoda s normami EN60898/IEC60898

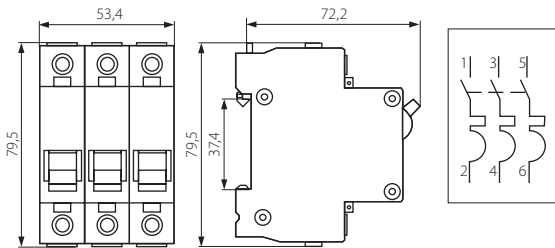

■ KS6 C16/3

Charakteristika prístroja

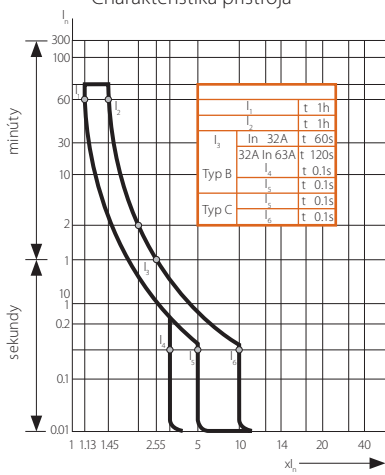

■ teleso: plast

Model	Kanlux Code	EAN	Farba	In	DKC SK bez DPH			
KS6 C6/3	04460	5905339044600	svetlo šedá	6A	12,12 €			
KS6 C10/3	04461	5905339044617	svetlo šedá	10A	12,12 €			
KS6 C16/3	04462	5905339044624	svetlo šedá	16A	12,12 €			
KS6 C20/3	04463	5905339044631	svetlo šedá	20A	12,48 €			
KS6 C25/3	04464	5905339044648	svetlo šedá	25A	13,91 €			
KS6 C32/3	04465	5905339044655	svetlo šedá	32A	14,97 €			
KS6 C40/3	04466	5905339044662	svetlo šedá	40A	15,34 €			
KS6 C50/3	04467	5905339044679	svetlo šedá	50A	15,67 €			
KS6 C63/3	04468	5905339044686	svetlo šedá	63A	16,03 €			

Un 400V~	50 Hz	Icn 6000A												
-------------	-------	--------------	--	--	--	--	--	--	--	--	--	--	--	--

■ slúži k ochrane elektrických obvodov a spotrebičov pred účinkami preťaženia a skratom v obvodoch s prúdovými rázmi  
 ■ zhoda s normami EN60898/IEC60898

Prúdový chránič

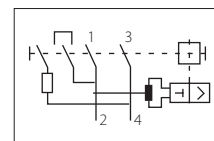
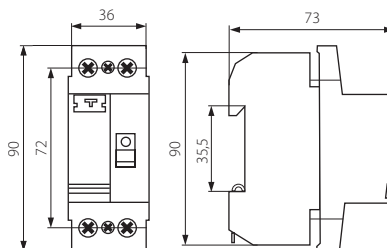

■ KR6 25/003/2

■ teleso: plast

Kanlux	Kanlux	EAN			In		DKC SK bez DPH
KR6 25/003/2	04470	5905339044709	svetlo šedá	čierna	25A	4000	27,52 €
KR6 40/003/2	04471	5905339044716	svetlo šedá	čierna	40A	3000	27,52 €
KR6 63/003/2	04472	5905339044723	svetlo šedá	čierna	63A	3000	27,52 €

Un 230V~	IΔn 0,03A	50 Hz	DIN 35mm	[mm²] 1÷25	IP 20		°C -5÷40		2P		1/-/60	215 [g]		
-------------	--------------	-------	----------	---------------	----------	--	-------------	--	----	--	--------	---------	--	--

- slúži k ochrane elektrických obvodov pred zvodovými prúdmi a k ochrane osôb pred úrazom elektrickým prúdom
- zhoda s normou EN61008
- určený k práci v obvodoch so striedavým prúdom (typ AC)

Prúdový chránič

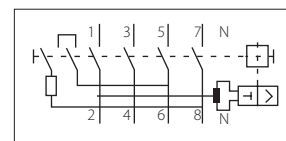
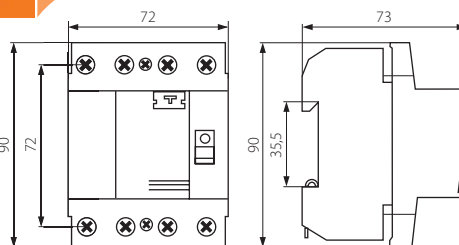

■ KR6 25/003/4

■ teleso: plast

Kanlux	Kanlux	EAN			In		DKC SK bez DPH
KR6 25/003/4	04485	5905339044853	svetlo šedá	čierna	25A	4000	35,12 €
KR6 40/003/4	04486	5905339044860	svetlo šedá	čierna	40A	3000	35,12 €
KR6 63/003/4	04487	5905339044877	svetlo šedá	čierna	63A	3000	35,12 €

Un 400V~	IΔn 0,03A	50 Hz	DIN 35mm	[mm²] 1÷25	IP 20		°C -5÷40		4P		1/-/30	350 [g]		
-------------	--------------	-------	----------	---------------	----------	--	-------------	--	----	--	--------	---------	--	--

- slúži k ochrane elektrických obvodov pred zvodovými prúdmi a k ochrane osôb pred úrazom elektrickým prúdom
- zhoda s normou EN61008
- určený k práci v obvodoch so striedavým prúdom (typ AC)



Kombinácia istič – prúdový chránič

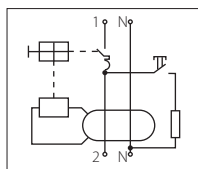
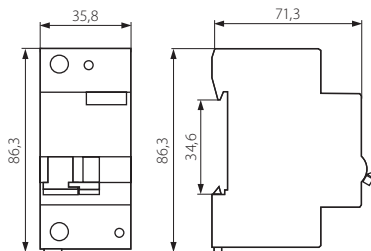

■ JVL5/2 B16/0,03A



■ JVL5/2 B25/0,03A

■ teleso: plast

		EAN 			In	DKC SK bez DPH
JVL5/2 B16/0,03A	03870	5905339038708	svetlo šedá	šedá	16A	34,19 €
JVL5/2 B25/0,03A	03871	5905339038715	svetlo šedá	žltá	25A	34,19 €

  

Un	IΔn	50 Hz	Icn					IP						
230V~	0,03A		6000A	B	DIN 35mm	4000	1÷6	20		-5÷40	2P	1/-/60	330	

- slúži k ochrane elektrických obvodov a spotrebičov pred účinkami preťaženia a skratom, k ochrane elektrických obvodov pred zvodovými prúdmi a k ochrane osôb pred úrazom elektrickým prúdom
- zhoda s normami EN61009-1/EN61009-2-1
- maximálny prierez stredného vodiča 2,5 mm<sup>2</sup>
- určený k práci v obvodoch so striedavým prúdom (typ AC)

## JVD1-100 1

Hlavný vypínač

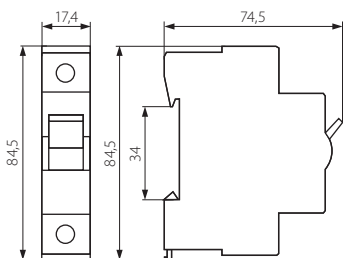

■ JVD1-100 1/25A



■ JVD1-100 1/40A

■ teleso: plast

		EAN 			In	DKC SK bez DPH
JVD1-100 1/25A	03810	5905339038104	svetlo šedá	žltá	25A	3,62 €
JVD1-100 1/40A	03811	5905339038111	svetlo šedá	čierna	40A	3,62 €

Un	50 Hz	Icn				IP						
230/400V~		3000A	DIN 35mm	10000	1÷25	20		-5÷40	1P	-/12/12	100	

- slúži k rozpojeniu obvodu pri menovitom prúde
- zhoda s normou EN60947-3
- kategória užitia AC-21A, AC-22A, AC-23A

# JVD1-100 3

**Kanlux**

Hlavný vypínač

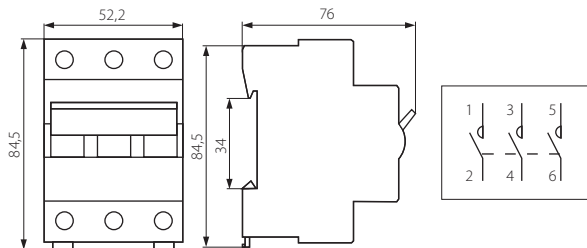

■ JVD1-100 3/80A

■ teleso: plast

Kanlux	Kanlux	EAN	svetlo šedá	žltá	In	DKC SK bez DPH
JVD1-100 3/25A	03815	5905339038159	svetlo šedá	žltá	25A	10,89 €
JVD1-100 3/40A	03816	5905339038166	svetlo šedá	čierna	40A	10,89 €
JVD1-100 3/63A	03817	5905339038173	svetlo šedá	červená	63A	10,89 €
JVD1-100 3/80A	03818	5905339038180	svetlo šedá	šedá	80A	10,89 €
JVD1-100 3/100A	03819	5905339038197	svetlo šedá	purpurová	100A	10,89 €

Un 400V~
50 Hz
Icn 3000A
DIN 35mm
10000
1mm<sup>2</sup> 1÷25
IP 20
-5÷40 °C
3P
-/4/40
295 [g]
CE

- slúži k rozpojeniu obvodu pri menovitom prúde
- zhoda s normou EN60947-3
- kategória užitia AC-21A, AC-22A, AC-23A

# JVC2-20/2

Stýkač

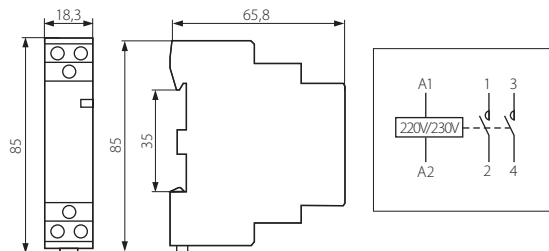

■ JVC2-20/2

■ teleso: plast

Kanlux	Kanlux	EAN	svetlo šedá	DKC SK bez DPH
JVC2-20/2	03801	5905339038012	svetlo šedá	12,91 €

Un 230V~
In 20A (AC7a)
50 Hz
DIN 35mm
1000000
1mm<sup>2</sup> 1÷4
IP 20
-5÷40 °C
1P
-/10/120
140 [g]
CE

- slúži k automatickému spínaniu elektrických spotrebičov
- zhoda s normami EN61095/EN60947-4-2
- maximálny spínaný výkon 4kW (AC7a); 1,2kW (AC7b)
- kategória užitia AC7a, AC7b



Elektrický zvonček

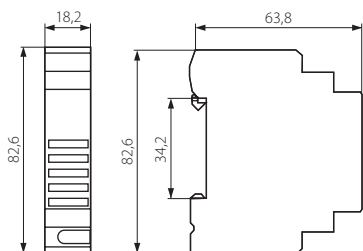

EB230 230V

teleso: plast

		EAN 		DKC SK bez DPH							
EB230 230V	03805	5905339038050	svetlo šedá	2,89 €							
Un 230V~	In 30mA	50 Hz	DIN 35mm	1+2,5	IP 20		 -5÷40	1P	 -/12/120	 79	

- služi k akustickej signalizácii stavu elektrických obvodov bez použitia zvonkového transformátoru
- zhoda s normami EN61095/EN60947-5-1
- maximálny príkon 6VA



Zvonkový transformátor

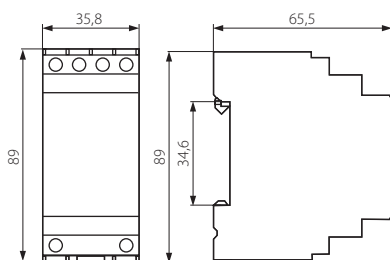

BT-8 8/12/24V

teleso: plast

		EAN 		Un	DKC SK bez DPH					
BT-8 8/12/24V	03806	5905339038067	svetlo šedá	PRI: 230V~, SEC: 8,12,24V~	9,19 €					
In 35mA	50 Hz	DIN 35mm	1+4	IP 20		 -5÷40	2P	 1/-/40	 420	

- služi k napájaniu zvonkových obvodov napätím 8, 12 alebo 24V~
- zhoda s normou EN61558
- maximálny výkon SEC 8VA
- transformátor nie je zkratuvzdorný

Svetelné návěstie LED



■ SL-GN GREEN

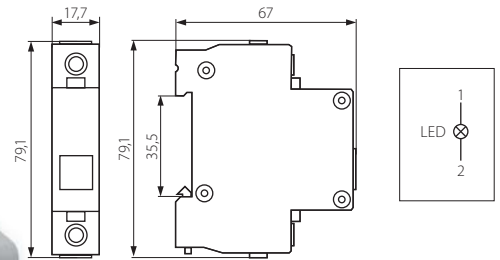

■ SL-RE RED

■ teleso: plast

<b>Kanlux</b>	<b>Kanlux</b>	EAN			DKC SK bez DPH
SL-GN GREEN	03821	5905339038210	světlo šedá	zelená	2,82 €
SL-RE RED	03820	5905339038203	světlo šedá	červená	2,82 €

Un	In	50 Hz	DIN 35mm	[mm <sup>2</sup> ]	IP			1P		[g]	CE
230V~	13mA			1÷6	20		-5÷40		-/12/120	60	

- slúži k svetelnej signalizácii stavu elektrických obvodov
- zhoda s normami EN61095/EN60947-5-1

## BBU

Prepojovacia lišta

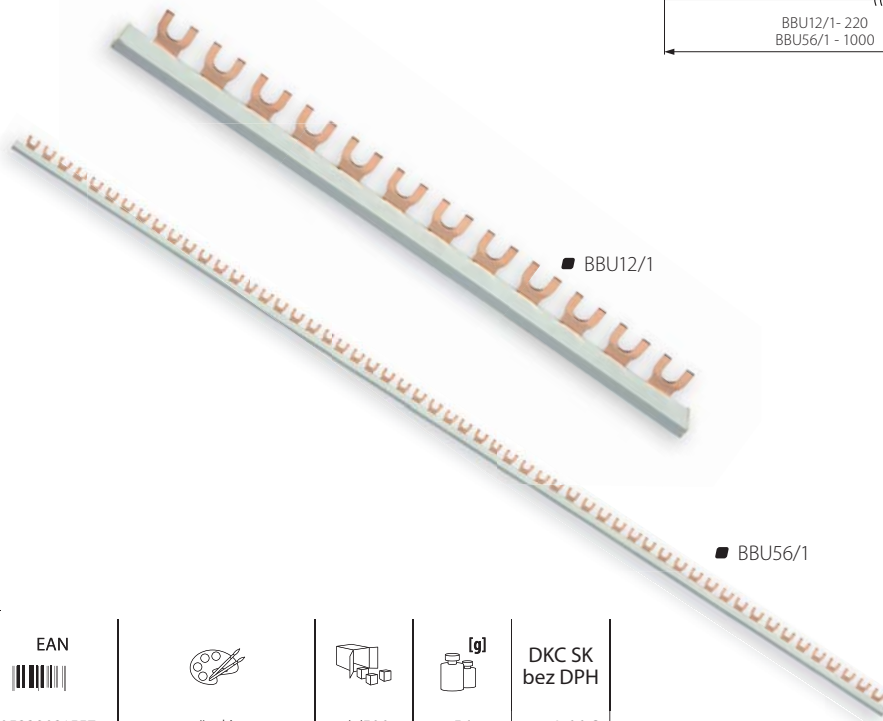

■ BBU12/1

■ BBU56/1

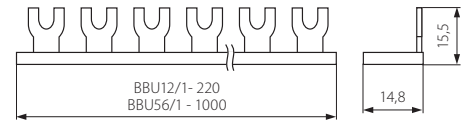

■ teleso: plast / prípojnica: meď

<b>Kanlux</b>	<b>Kanlux</b>	EAN			[g]	DKC SK bez DPH
BBU12/1	02155	5905339021557	šedá	-/500	56	1,66 €
BBU56/1	02157	5905339021571	šedá	-/100	265	7,34 €

Un	In		CE
230/400V~	max 63A		

- slúži k pripojeniu svoriek modulárnych prístrojov
- zhoda s normami EN60439-1/EN60439-2
- model BBU12/1 slúži k prepoineniu max. 12 jednofázových zariadení, model BBU56/1 slúži k prepoineniu max. 56 jednofázových zariadení



Prepojovacia lišta

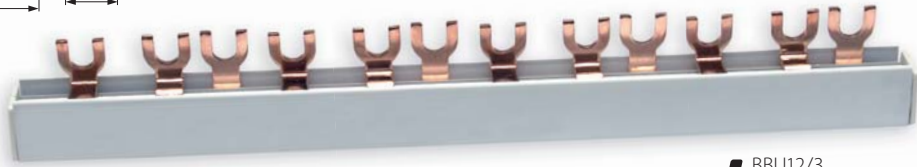
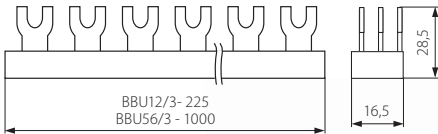

■ BBU12/3



■ BBU54/3

■ teleso: plast / prípojnica: meď

Kanlux	Kanlux	EAN			[g]	DKC SK bez DPH
BBU12/3	02156	5905339021564	šedá	-/-/200	145	4,08 €
BBU54/3	02158	5905339021588	šedá	-/-/30	735	17,36 €



- slúži k pripojeniu svoriek modulárnych prístrojov
- zhoda s normami EN60439-1/EN60439-2
- model BBU12/3 slúži k prepojeniu max. 4 jednofázových zariadení, model BBU54/3 slúži k prepojeniu max. 18 trojfázových zariadení



## Z1-BBU/3

Koncová krytka

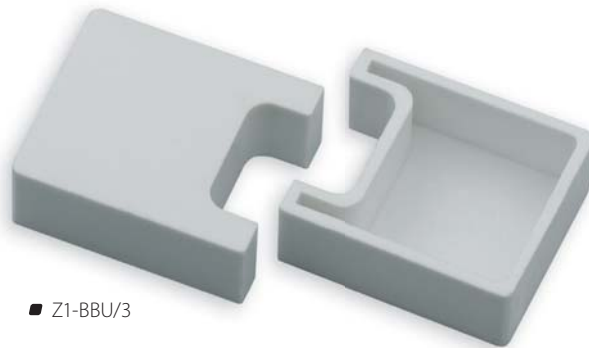
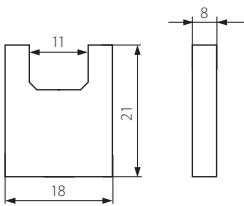

■ Z1-BBU/3

■ koncová krytka: plast

Kanlux	Kanlux	EAN		DKC SK bez DPH
Z1-BBU/3	02159	5905339021595	šedá	0,09 €



- slúži na zakončenie pripojovacích lišt BBU12/3 i BBU54/3
- cena za komplet obsahujúci 2 kusy

Čelná krytka do rozvádzačov typu DB

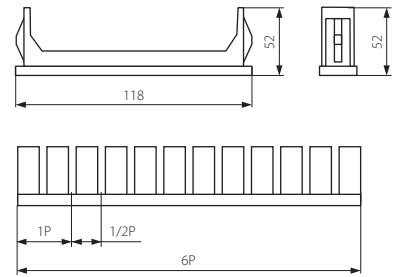

■ Z-DB

■ koncová krytka: plast

		EAN 		DKC SK bez DPH
Z-DB	03859	5905339038593	šedá	0,96 €
-/10/500	18	[g]		

- slúži k zakrytiu nevyužitého miesta v rozvádzačov typu DB
- cena za sadu, jejž súčasťou sú koncové krytky 2xP+8x0,5P=6P

## DB1

Plastový rozvádzač s DIN lištou

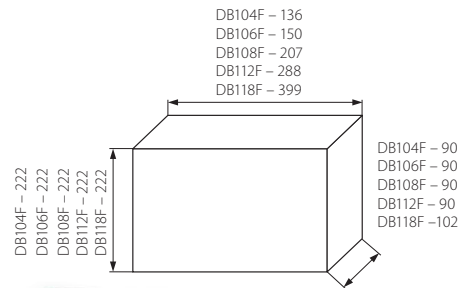

■ teleso a dvierka rozvádzača: ABS

		EAN 					DKC SK bez DPH
DB104F 1X4P/FMD	03840	5905339038401	biela/hnedá	4P	1/-/20	450	10,89 €
DB106F 1X6P/FMD	03841	5905339038418	biela/hnedá	6P	1/-/20	650	11,52 €
DB108F 1X8P/FMD	03842	5905339038425	biela/hnedá	8P	1/-/20	750	13,51 €
DB112F 1X12P/FMD	03843	5905339038432	biela/hnedá	12P	1/-/10	950	15,07 €
DB118F 1X18P/FMD	03844	5905339038449	biela/hnedá	18P	1/-/10	1250	22,31 €



- dvierka s otváraním smerom nahor
- mechanická odolnosť odpovedá IK06
- maximálna prípustná teplota skrinky 70 °C
- tepelná odolnosť skrinky 850 °C, pre elektrickú výbavu 650 °C/30s

Plastový rozvádzač s DIN lištou

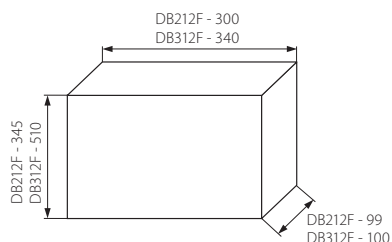

■ DB312F 3X12P/FMD



■ DB212F 2X12P/FMD

■ teleso a dvierka rozvádzača: ABS

						<b>DKC SK bez DPH</b>
DB212F 2X12P/FMD	03845	5905339038456	biela/hnedá	2 x 12P	1300	22,41 €
DB312F 3X12P/FMD	03846	5905339038463	biela/hnedá	3 x 12P	1950	35,72 €



- dvierka s otváraním smerom nahor
- mechanická odolnosť odpovedá IK06
- maximálna prípustná teplota skrinky 70 °C
- tepelná odolnosť skrinky 850 °C, pre elektrickú výbavu 650 °C/30s

Plastový rozvádzač s DIN lištou

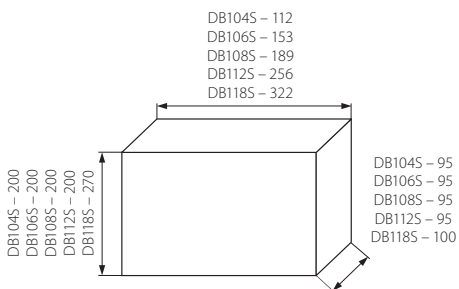

■ DB1045 1X4P/SMD



■ DB1065 1X6P/SMD



■ DB1125 1X12P/SMD



■ DB1185 1X18P/SMD



■ DB1085 1X8P/SMD

■ teleso a dvierka rozvádzača: ABS

						<b>DKC SK bez DPH</b>
DB1045 1X4P/SMD	03830	5905339038302	biela/hnedá	4P	500	7,30 €
DB1065 1X6P/SMD	03831	5905339038319	biela/hnedá	6P	650	7,47 €
DB1085 1X8P/SMD	03832	5905339038326	biela/hnedá	8P	750	8,50 €
DB1125 1X12P/SMD	03833	5905339038333	biela/hnedá	12P	950	14,84 €
DB1185 1X18P/SMD	03834	5905339038340	biela/hnedá	18P	1300	21,64 €



- dvierka s otváraním smerom nahor
- mechanická odolnosť odpovedá IK06
- maximálna prípustná teplota skrinky 70 °C
- tepelná odolnosť skrinky 850 °C, pre elektrickú výbavu 650 °C/30s

Plastový rozvádzač s DIN lištou



■ DB212S 2X12P/SMD



■ DB312S 3X12P/SMD

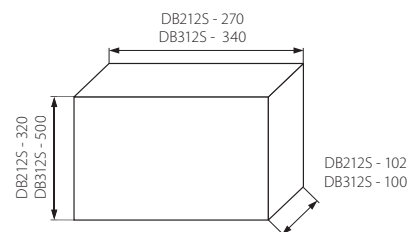

■ teleso a dverka rozvádzača: ABS

Kanlux	Kanlux	EAN				[g]	DKC SK bez DPH
DB212S 2X12P/SMD	03835	5905339038357	biela/hnedá	2 x 12P	1/-/10	1300	23,70 €
DB312S 3X12P/SMD	03836	5905339038364	biela/hnedá	3 x 12P	1/-/5	2030	36,48 €



- dverka s otváraním smerom nahor
- mechanická odolnosť odpovedá IK06
- maximálna prípustná teplota skrinky 70 °C
- tepelná odolnosť skrinky 850 °C, pre elektrickú výbavu 650 °C/30s

## DB1

Plastový rozvádzač s DIN lištou

■ DB104W 1X4P/SM



■ DB108W 1X8P/SM



■ DB112W 1X12P/SM



■ DB118W 1X18P/SM

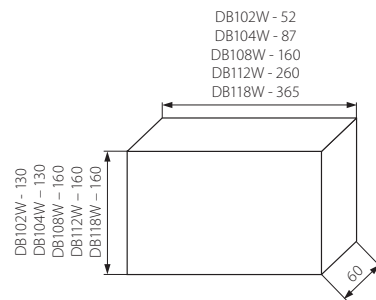

■ teleso: ABS

Kanlux	Kanlux	EAN				[g]	DKC SK bez DPH
DB102W 1X2P/SM	03850	5905339038500	biela	2P	-/10/200	75	1,93 €
DB104W 1X4P/SM	03851	5905339038517	biela	4P	-/5/100	120	1,93 €
DB108W 1X8P/SM	03852	5905339038524	biela	8P	-/2/50	200	7,77 €
DB112W 1X12P/SM	03853	5905339038531	biela	12P	1/-/20	350	12,08 €
DB118W 1X18P/SM	03854	5905339038548	biela	18P	1/-/20	525	14,54 €



- mechanická odolnosť odpovedá IK06
- maximálna prípustná teplota skrinky 70 °C
- tepelná odolnosť skrinky 850 °C



■ DB102W 1X2P/SM





[www.kanlux.sk](http://www.kanlux.sk)

**Kanlux**



Elektroinštalačný materiál

Ventilátor s automatickou žalúziou

Charakteristika ventilátora

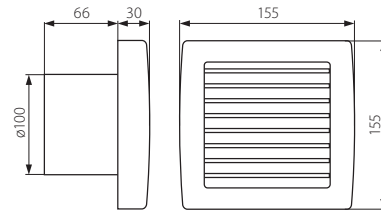
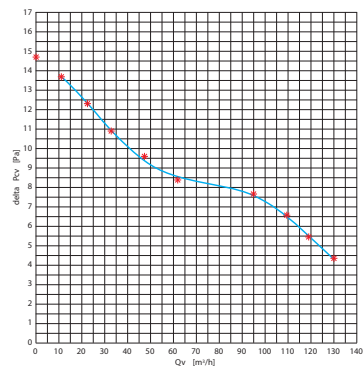

■ TWISTER AOL100B

■ plastové teleso a lopatky ventilátora

Kanlux	Kanlux	EAN	Color	Timer	Weight [g]	Price
TWISTER AOL100B	70926	5905339709264	biela	-	540	28,78 €
TWISTER AOL100T	70953	5905339709530	biela	+	580	35,78 €



- počet otáčiek 2550/min
- všetky modely vybavené automatickou žalúziou, ktorá sa uzatvára po ukončení činnosti ventilátora

- objemový prietok vzdušiny 100m³/h
- hladina hluku 42dB (A)

# TWISTER AOL120

Ventilátor s automatickou žalúziou

Charakteristika ventilátora

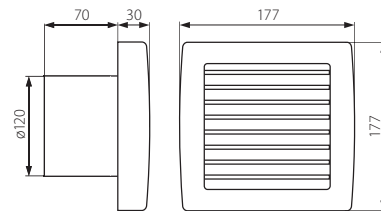
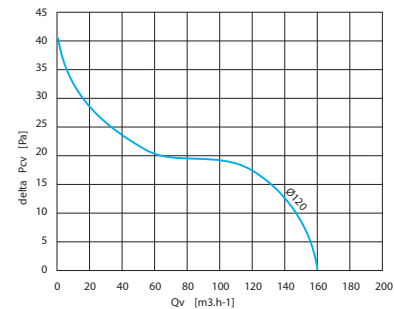

■ TWISTER AOL120B

■ plastové teleso a lopatky ventilátora

Kanlux	Kanlux	EAN	Color	Timer	Weight [g]	Price
TWISTER AOL120B	70956	5905339709561	biela	-	615	30,14 €
TWISTER AOL120T	70960	5905339709608	biela	+	630	42,62 €



- počet otáčiek 2550/min
- všetky modely vybavené automatickou žalúziou, ktorá sa uzatvára po ukončení činnosti ventilátora

- objemový prietok vzdušiny 100m³/h
- hladina hluku 42dB (A)

Ventilátor

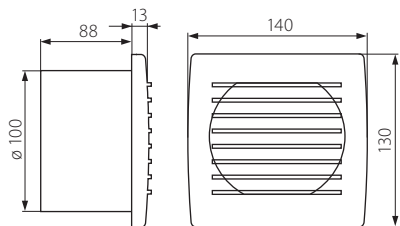

■ CYKLON EOL100B

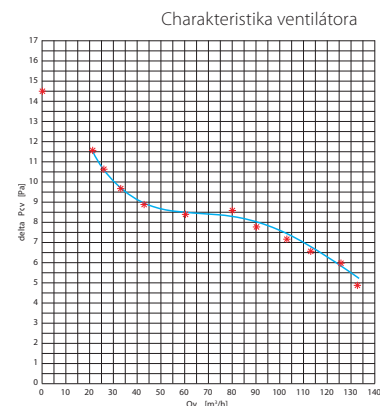

■ plastové teleso a lopatky ventilátora

Kanlux	Kanlux	EAN	Color	ON/OFF	ON/OFF	Accessories	[g]	DKC SK bez DPH
CYKLON EOL100B	70911	5905339709110	biela	-	-	svorkovnica 2 x 1mm <sup>2</sup>	485	10,52 €
CYKLON EOL100P	70937	5905339709370	biela	+	-	svorkovnica 2 x 1mm <sup>2</sup>	480	12,85 €
CYKLON EOL100	70910	5905339709103	biela	+	-	vidlica 190cm, 2 x 0,75mm <sup>2</sup>	550	13,54 €
CYKLON EOL100T	70938	5905339709387	biela	-	+	svorkovnica 2 x 1mm <sup>2</sup>	470	21,04 €
CYKLON EOL100HT	70936	5905339709363	biela	-	+	svorkovnica 2 x 1mm <sup>2</sup>	475	30,04 €



- počet otáčiek 2550/min
- model CYKLON EOL100HT vybavený čidlom vlhkosti umožňujúci zapnutie ventilátora po dosiahnutí nastavenej úrovni vlhkosti

- objemový prietok vzdušiny 100m<sup>3</sup>/h
- hladina hluku 38dB (A)

## CYKLON EOL120

Ventilátor

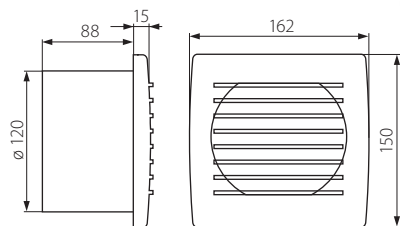

■ CYKLON EOL120B

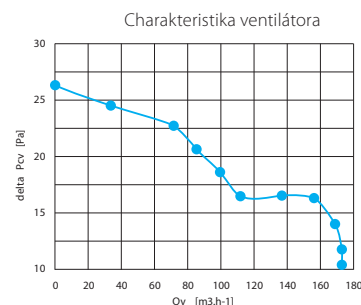

■ plastové teleso a lopatky ventilátora

Kanlux	Kanlux	EAN	Color	ON/OFF	ON/OFF	Accessories	[g]	DKC SK bez DPH
CYKLON EOL120B	70916	5905339709110	biela	-	-	svorkovnica 2 x 1mm <sup>2</sup>	530	12,08 €
CYKLON EOL120P	70942	5905339709370	biela	+	-	svorkovnica 2 x 1mm <sup>2</sup>	530	13,74 €
CYKLON EOL120	70915	5905339709103	biela	+	-	vidlica 190cm, 2 x 0,75mm <sup>2</sup>	600	14,87 €
CYKLON EOL120T	70943	5905339709387	biela	-	+	svorkovnica 2 x 1mm <sup>2</sup>	520	22,61 €
CYKLON EOL120HT	70941	5905339709363	biela	-	+	svorkovnica 2 x 1mm <sup>2</sup>	530	31,47 €



- počet otáčiek 2550/min
- model CYKLON EOL120HT vybavený čidlom vlhkosti umožňujúci zapnutie ventilátora po dosiahnutí nastavenej úrovni vlhkosti

- objemový prietok vzdušiny 150m<sup>3</sup>/h
- hladina hluku 38dB (A)

## Ventilátor

Charakteristika ventilátora

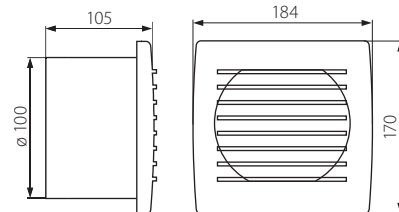
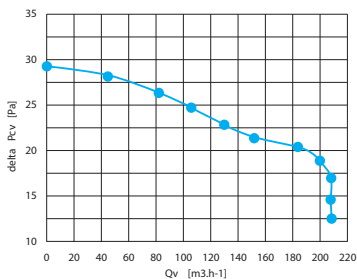

■ CYKLON EOL150B

■ plastové těleso a lopatky ventilátora

Kanlux	Kanlux	EAN	Color	Off/On	Off/On	Accessories	[g]	DKC SK bez DPH
CYKLON EOL150B	70921	5905339709219	biela	-	-	svorkovnica 2 x 1mm <sup>2</sup>	570	13,01 €
CYKLON EOL150P	70947	5905339709479	biela	+	-	svorkovnica 2 x 1mm <sup>2</sup>	560	14,64 €
CYKLON EOL150	70920	5905339709202	biela	+	-	vidlica 190cm, 2 x 0,75mm <sup>2</sup>	640	15,83 €
CYKLON EOL150T	70948	5905339709486	biela	-	+	svorkovnica 2 x 1mm <sup>2</sup>	570	23,57 €



■ hladina hluku 38dB (A)  
 ■ objemový prietok vzdušiny 200m<sup>3</sup>/h

■ počet otáčiek 2550/min

# WIR WK

## Ventilátor

Charakteristika ventilátora

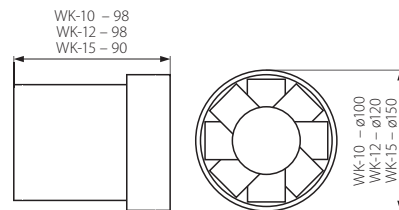
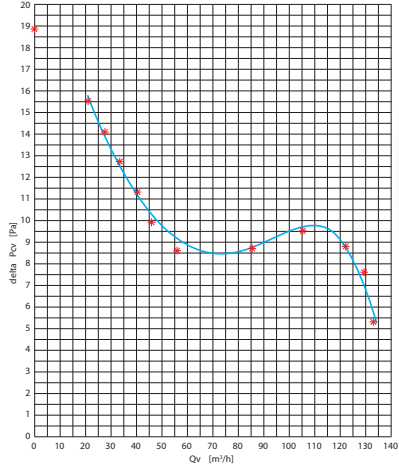

■ WIR WK-12

■ plastové těleso a lopatky ventilátora

Kanlux	Kanlux	EAN	Color	[W]	[g]	DKC SK bez DPH
WIR WK-10	70900	5905339709004	biela	19	460	10,79 €
WIR WK-12	70901	5905339709011	biela	20	480	11,75 €
WIR WK-15	70903	5905339709035	biela	22	490	16,17 €



■ hladina hluku ventilátoru WIR WK-10 je 39dB (A), u ostatných modelov je 41dB (A)  
 ■ objemový prietok vzdušiny u WIR WK-10 je 100 m<sup>3</sup>/h, u WIR WK-12 je 150m<sup>3</sup>/h, u WIR WK-15 je 200m<sup>3</sup>/h

■ počet otáčiek 2550/min



Spätňá klapka

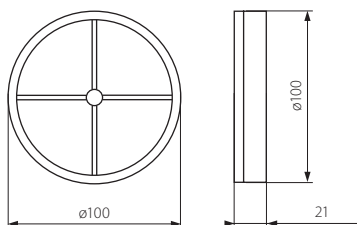

■ WIR ZL100

■ plastové teleso a klapky

		EAN 			DKC SK bez DPH
WIR ZL100	70961	8594056490349	biela	25	3,49 €



-I-/240

## TEMA DX



Predlžovacia šnúra s ochranným vodičom

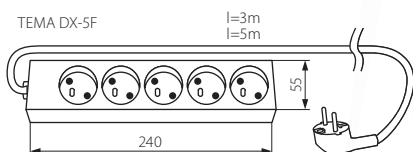
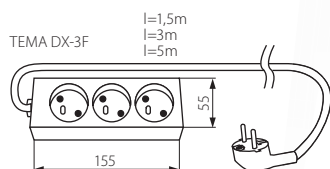

■ TEMA DX-3F

■ TEMA DX-5F



■ teleso zásuvek: plast / materiál šnúry, vidlice: PVC / materiál žil šnúry: meď

		EAN 				DKC SK bez DPH
TEMA DX-3F 1.5M	01500	5905339015006	biela	1,5m, 3 x 1mm <sup>2</sup>	220	2,82 €
TEMA DX-3F 3M	01502	5905339015020	biela	3m, 3 x 1mm <sup>2</sup>	370	3,68 €
TEMA DX-3F 5M	01504	5905339015044	biela	5m, 3 x 1mm <sup>2</sup>	550	7,14 €
TEMA DX-5F 3M	01558	5905339015587	biela	3m, 3 x 1mm <sup>2</sup>	440	5,81 €
TEMA DX-5F 5M	01560	5905339015600	biela	5m, 3 x 1mm <sup>2</sup>	580	8,00 €



Predĺžovacia šnúra s ochranným vodičom a vypínačom

■ TEMA DX-3FS



■ TEMA DX-5FS

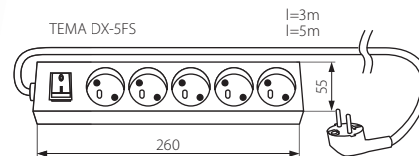
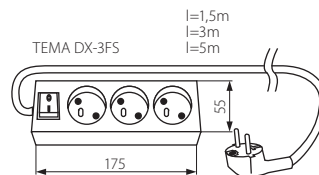

■ teleso zásuviek: plast / materiál šnúry, vidlice: PVC / materiál žil šnúry: meď

Kanlux	Kanlux	EAN			[g]	DKC SK bez DPH
TEMA DX-3FS 1.5M	01507	5905339015075	biela	1,5m, 3 x 1mm <sup>2</sup>	280	3,68 €
TEMA DX-3FS 3M	01509	5905339015099	biela	3m, 3 x 1mm <sup>2</sup>	400	5,54 €
TEMA DX-3FS 5M	01511	5905339015112	biela	5m, 3 x 1mm <sup>2</sup>	550	7,63 €
TEMA DX-5FS 3M	01565	5905339015655	biela	3m, 3 x 1mm <sup>2</sup>	450	6,27 €
TEMA DX-5FS 5M	01567	5905339015679	biela	5m, 3 x 1mm <sup>2</sup>	610	8,63 €



# FINAR DX-02-Y 1.0

Predĺžovacia šnúra s ochranným vodičom



■ FINAR DX-02-Y 1.0 5M

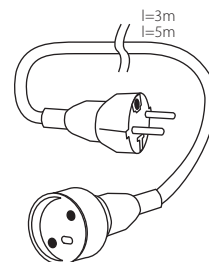

■ materiál šnúry, vidlice, spojovacej zásuvky: PVC / materiál žil šnúry: meď

Kanlux	Kanlux	EAN			[g]	DKC SK bez DPH
FINAR DX-02-Y 1.0 3M	02020	5905339020208	biela	3m, 3 x 1mm <sup>2</sup>	380	3,58 €
FINAR DX-02-Y 1.0 5M	02021	5905339020215	biela	5m, 3 x 1mm <sup>2</sup>	540	5,31 €



Predlžovacia šnúra s ochranným vodičom

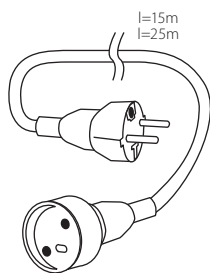

■ MIZAK DX-02-Y 1.5 15M

■ materiál šnúry, vidlice, spojovacej zásuvky: PVC / materiál žil šnúry: meď

		EAN 					DKC SK bez DPH

## MANGO KF-FBG

Predlžovací kábel na bubne s ochranným vodičom

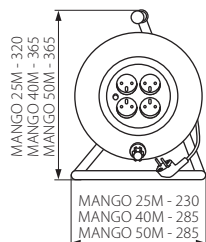

■ MANGO KF-FBG-23A 40M

■ buben: plast / stojan: ocel / materiál šnúry, vidlice: PVC / materiál žil šnúry: meď

		EAN 				DKC SK bez DPH							
							MANGO KF-FBG-20A 25M MANGO KF-FBG-23A 40M MANGO KF-FBG-23A 50M	04395 04396 04397	5905339043955 5905339043962 5905339043979	čierna čierna čierna	25m, 3 x 1,5mm <sup>2</sup> 40m, 3 x 1,5mm <sup>2</sup> 50m, 3 x 1,5mm <sup>2</sup>	3750 5600 6600	41,92 € 59,88 € 67,88 €

- predlžovací kábel vybavený ochranou proti preťaženiu
- predlžovacia šnúra s ochranným vodičom určená pre el. zariadenie triedy izolácie I
- jednotlivé zásuvky vybavené detskou poistkou

Pripojovacia šnúra

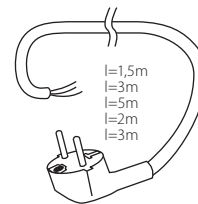

■ LIGO DX-3G1.0MM2 1.5M

■ materiál šnúry, vidlice: PVC / materiál žil šnúry: meď

Kanlux	Kanlux	EAN
LIGO DX-3G1.0MM2 1.5M	01782	5905339017826
LIGO DX-3G1.0MM2 3M	01780	5905339017802
LIGO DX-3G1.0MM2 5M	01781	5905339017819
LIGO DX-3G1.5MM2 2M	01785	5905339017857
LIGO DX-3G1.5MM2 3M	01786	5905339017864



biela  
biela  
biela  
biela  
biela



1,5m, 3 x 1mm<sup>2</sup>  
3m, 3 x 1mm<sup>2</sup>  
5m, 3 x 1mm<sup>2</sup>  
2m, 3 x 1,5mm<sup>2</sup>  
3m, 3 x 1,5mm<sup>2</sup>



[g]  
350  
500  
600  
500  
650

DKC SK bez DPH  
3,09 €  
3,95 €  
4,45 €  
3,82 €  
5,41 €



■ je vybavená ochranným vodičom

ZARK KR

Rozbočka



■ ZARK KRT/2-1



ZARK KRT/2-1

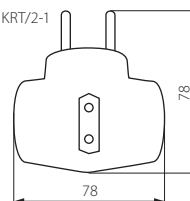

ZARK KRW-3

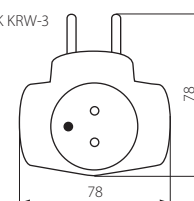

■ ZARK KRW-3

■ teleso: plast

Kanlux	Kanlux	EAN
ZARK KRT/2-1	02180	5905339021809
ZARK KRW-3	70516	9008954020793



biela  
biela



[g]  
88  
86

DKC SK bez DPH  
1,10 €  
1,20 €



■ vybavené ochranným kontaktom



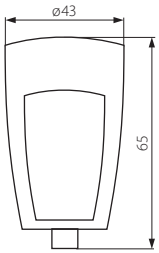

■ DAN KGP-1

■ teleso: plast

		EAN 
DAN KGP-1	02185	5905339021854
	In <b>16A</b>	IP <b>20</b>



biela



1/25/200



38

DKC SK  
bez DPH

0,86 €

■ vybavená ochranným kontaktom



PIN W/US

NANO W-1

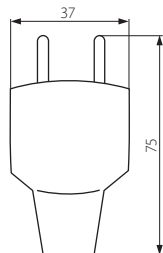
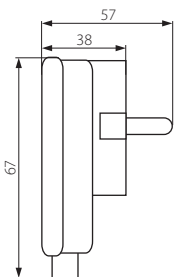

■ PIN W/US

■ teleso: plast

		EAN 
PIN W/US	02186	5905339021861
	In <b>16A</b>	IP <b>20</b>



biela



1/25/200



40

DKC SK  
bez DPH

0,86 €

■ vybavená ochranným kontaktom

Spojovacia zásuvka s vyšším krytím

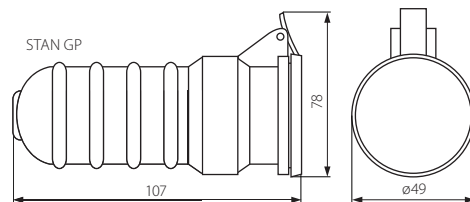

■ STAN GP

■ teleso: pryž a plast

		EAN 			DKC SK bez DPH
STAN GP	04864	5905339048646	čierna	90	2,72 €

■ spadá do I. triedy ochrany pred úrazom elektrickým prúdom

# GRIP W/US

Vidlica s vyšším krytím

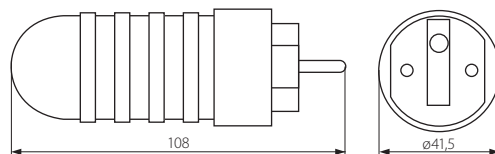

■ GRIP W/US

		EAN 		DKC SK bez DPH
GRIP W/US	04863	5905339048639	čierna	1,99 €

■ model Uni-Schuko

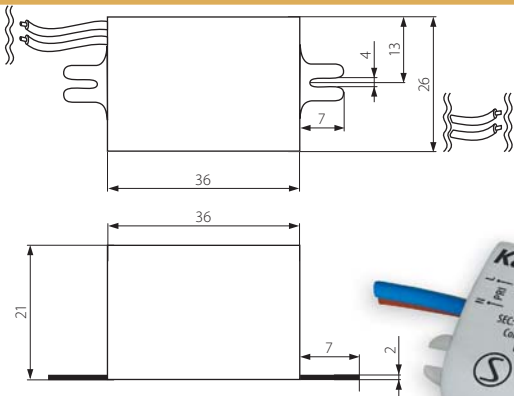

■ ADI 65

Elektronický transformátor pre napájanie LED svetidiel

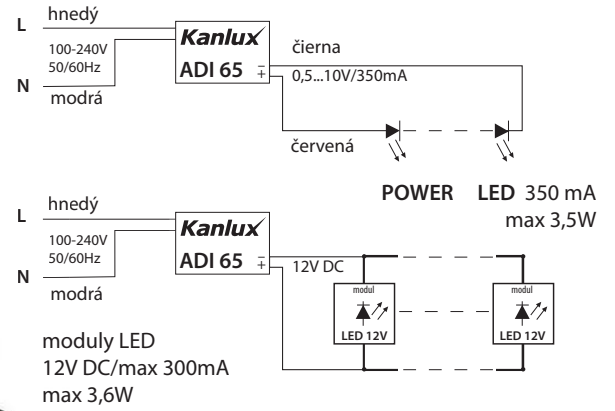

■ teleso: plast

		EAN 		<b>PRI</b>	<b>SEC</b>	DKC SK bez DPH
ADI 65	01440	5905339014405	biela	100-240V~	12V DC, 350mA DC constans	13,94 €
In 0,08A		4 x 0,75mm <sup>2</sup> 10 cm	IP 20			
	max 3			max 50	1/-/100	42

- výstupné napätie 12V DC alebo stabilizovaný prúd 350mA DC
- maximálna prípustná teplota telesa transformátora je 75 °C
- tepelná poisťka vypínajúca transformátor pri prekročení teploty 110 °C
- ochrana proti skratu
- ochrana proti preťaženiu

## RICO LED

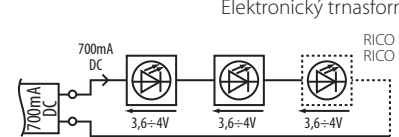
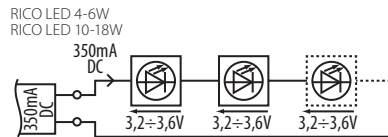
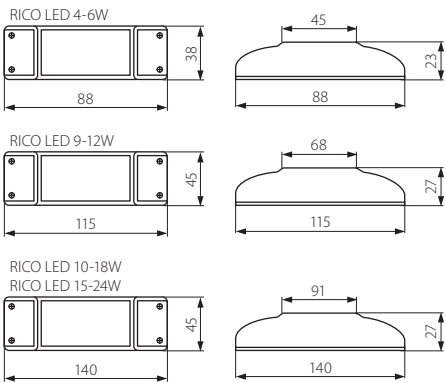

Elektronický transformátor LED

RICO LED 9-12W  
RICO LED 15-24W

■ RICO LED 4-6W

■ RICO LED 9-12W

■ RICO LED 10-18W

■ RICO LED 15-24W

■ teleso: plast

		EAN 		<b>PRI</b>	<b>SEC</b>	In	Tc		DKC SK bez DPH
<b>NEW</b> RICO LED 4-6W	07300	5905339073006	biela	220-240V~ 50/60Hz	DC 350mA (12V-24V) 4...6 x 1W	0,055A	75°C	56	9,30 €
<b>NEW</b> RICO LED 9-12W	07303	5905339073037	biela	220-240V~ 50/60Hz	DC 700mA (9V-16V) 3...4 x 3W	0,09A	80°C	98	13,85 €
<b>NEW</b> RICO LED 10-18W	07302	5905339073020	biela	220-240V~ 50/60Hz	DC 350mA (30V-72V) 10...18 x 1W	0,20A	80°C	116	16,62 €
<b>NEW</b> RICO LED 15-24W	07301	5905339073013	biela	220-240V~ 50/60Hz	DC 700mA (15V-36V) 5...8 x 3W	0,15A	80°C	116	17,23 €

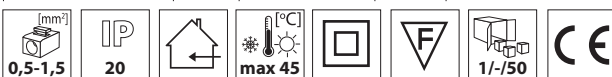

- stabilizácia prúdu 350mA DC
- max. prípustná teplota pláštka Tc: 75 °C
- tepelná poisťka vypínajúca napájač pri prekročení vnútornej teploty T: 110 °C
- ochrana proti skratu
- ochrana proti preťaženiu

# TRETO LED



Elektronický transformátor pre napájanie LED svetiel



■ TRETO LED

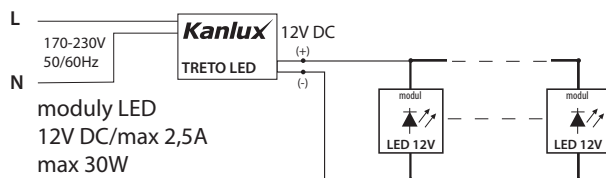
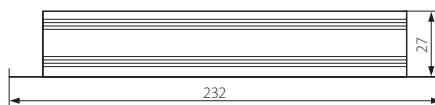
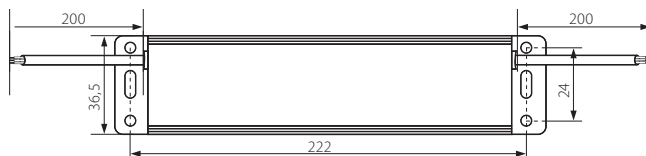

■ teleso: anodizovaný hliník

		EAN 		<b>PRI</b>	<b>SEC</b>	DKC SK bez DPH		
TRETO LED	07800	5905339078001	chróm	170-230V~50/60Hz	DC 2,5A (12V) 0...30W	23,04 €		

- stabilizácia napätia 12V DC
- max. prípustná teplota plásta Tc: 65 °C
- ochrana proti skratu

# SET

Elektronický transformátor



■ SET60 ULTRA SLIM



■ SET80 ULTRA SLIM

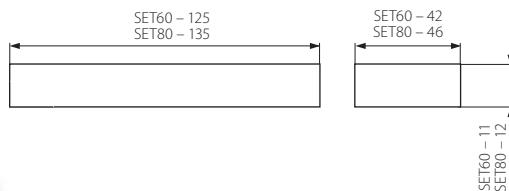

■ teleso: plast

		EAN 			<b>PRI</b>	<b>SEC</b>		DKC SK bez DPH
SET60 ULTRA SLIM	01435	5905339014351	biela	60	220-240V~; 50Hz; 0,27A	11,5V~; 60VA	70	12,78 €
SET80 ULTRA SLIM	01436	5905339014368	biela	80	220-240V~; 50Hz; 0,36A	11,5V~; 80VA	90	14,07 €

- účinník cosφ = 0,97
- maximálna prípustná teplota telesa transformátora je 85 °C
- tepelná poisťka vypínajúca transformátor pri prekročení teploty 110 °C
- ochrana proti skratu
- ochrana proti preťaženiu

## Elektronický transformátor

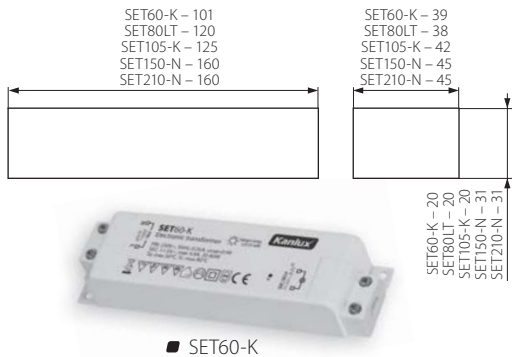

teleso: plast

Kanlux	Kanlux	EAN		[W]	PRI	SEC	[°C]		[g]	DKC SK bez DPH
SET60-K	01425	5905339014252	biela	60	220-240V~; 50Hz; 0,26A	11,5V~; 4,9A; 60VA	max 50	1/-/100	76	12,05 €
SET80LT	01421	5905339014214	biela	80	230V~; 50Hz; 0,35A	11,5V~; 6,9A; 80VA	max 50	1/-/100	110	12,91 €
SET105-K	01426	5905339014269	biela	105	220-240V~; 50Hz; 0,45A	11,5V~; 8,8A; 105VA	max 40	1/-/100	94	12,08 €
SET150-N	01432	5905339014320	biela	150	220-240V~; 50Hz; 0,68A	11,5V~; 150VA	max 45	1/-/50	210	16,80 €
SET210-N	01433	5905339014337	biela	210	220-240V~; 50Hz; 0,95A	11,5V~; 210VA	max 45	1/-/50	240	22,87 €

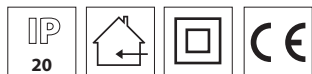

- účinník SET60-K a SET105-K  $\cos\phi = 0,99$ , u SET80LT, SET150-N a SET210-N  $\cos\phi = 0,97$
- maximálna prípustná teplota telesa transformátora SET 60-K je 80 °C, u ostatných modelov je 85 °C
- tepelná poistka vypínajúca model SET 80LT pri prekročení teploty 100 °C, modely SET150-N a SET210-N pri prekročení teploty 110 °C, u modelov SET60-K a SET105-K pri prekročení teploty 120 °C
- ochrana proti skratu
- ochrana proti preťaženiu

## OTON RT

Toroidný transformátor s tepelnou poistkou

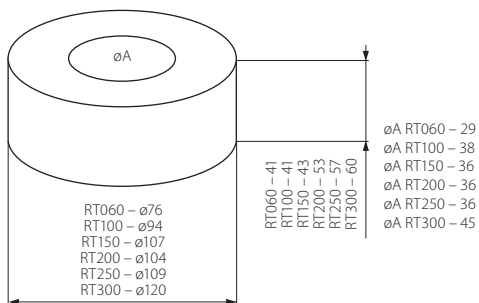

vinutie: meď

Kanlux	Kanlux	EAN	[W]	PRI	SEC		[g]	DKC SK bez DPH
OTON RT060-1011K	70402	5905339704023	60	230V; 50-60Hz	11,5V; 60VA	-/-/10	760	20,58 €
OTON RT100-1011K	70403	5905339704030	100	230V; 50-60Hz	11,5V; 100VA	-/-/10	1060	26,65 €
OTON RT150-1011K	70426	5905339704269	150	230V; 50-60Hz	11,5V; 150VA	-/-/10	1380	33,86 €
OTON RT200-1011K	70406	5905339704061	200	230V; 50-60Hz	11,5V; 200VA	-/-/10	2060	44,61 €
OTON RT250-1011K	70407	5905339704078	250	230V; 50-60Hz	11,5V; 250VA	-/-/5	2280	47,14 €
OTON RT300-1011K	70408	5905339704085	300	230V; 50-60Hz	11,5V; 300VA	-/-/5	2600	59,42 €

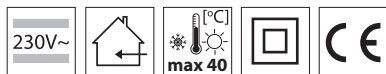

- možné použitie so stmievačom
- tepelná poistka vypínajúca transformátor pri prekročení teploty 120 °C
- bezpečnostný skratuzvodný transformátor

## Elektronický predradník triedy A2

- BL-118H-EVG
- BL-218H-EVG
- BL-136H-EVG
- BL-236H-EVG
- BL-158H-EVG
- BL-258H-EVG

BL-118H-EVG  
BL-218H-EVG  
BL-136H-EVG

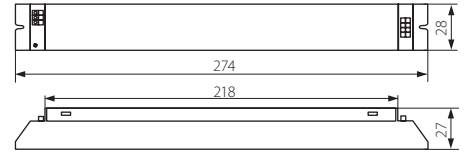

BL-236H-EVG  
BL-258H-EVG  
BL-158H-EVG

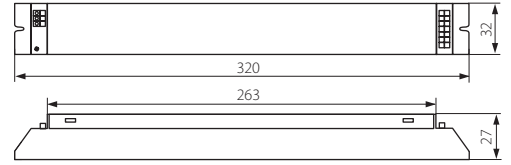

■ teleso: oceľový plech

Kanlux	Kanlux	EAN		In	[W]	[g]	DKC SK bez DPH
BL-118H-EVG	70480	5905339704801		0,08A	1 x 18	210	9,56 €
BL-218H-EVG	70483	5905339704832		0,16A	2 x 18	230	10,70 €
BL-136H-EVG	70481	5905339704818		0,16A	1 x 36	210	9,91 €
BL-236H-EVG	70484	5905339704849		0,32A	2 x 36	285	11,99 €
BL-158H-EVG	70482	5905339704825		0,26A	1 x 58	280	11,97 €
BL-258H-EVG	70485	5905339704856		0,51A	2 x 58	310	15,76 €



■ slúži ku stabilizácii prúdu žiarivok T8

## MB

## Indukčný predradník triedy B2



■ MB18/20

■ MB36/40

■ MB58

MB18/20  
MB36/40

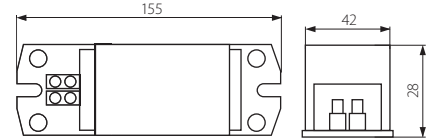

MB58

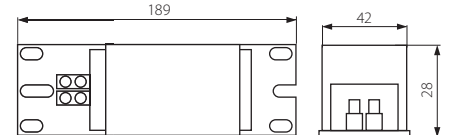

■ jadro: elektrotechnický plech

Kanlux	Kanlux	EAN		In	[W]	PRI	[g]	DKC SK bez DPH
MB18/20	70470	5905339704702		0,37A	18	230V/50Hz	605	5,97 €
MB36/40	70471	5905339704719		0,43A	36	230V/50Hz	645	5,97 €
MB58	70472	5905339704726		0,67A	58	230V/50Hz	1005	8,10 €



- slúži ku stabilizácii prúdu žiarivok T8
- maximálna teplota vinutia 130 °C
- obsahuje tepelnú poistku

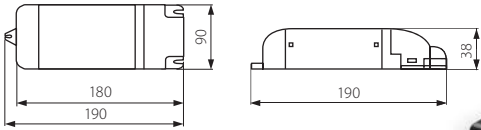

■ ANA 35



■ ANA 70



■ ANA 150

■ teleso: hliník / boky: umelá hmota

	<b>Kanlux</b>	<b>Kanlux</b>	EAN		In	[W]	[g]	DKC SK bez DPH
<b>NEW</b>	ANA 35	07270	5905339072702	čierna	0,15A	35	500	43,60 €
<b>NEW</b>	ANA 70	07271	5905339072719	čierna	0,30A	70	515	43,60 €
<b>NEW</b>	ANA 150	07272	5905339072726	čierna	0,72A	150	650	43,60 €



- slúži k stabilizácii prúdu v metalhalogenidových výbojkách a vysokotlakých sodíkových výbojkách
- obsahuje tepelnú poistku
- bezpečné v situácii práce s vadnou alebo poškodenou výbojkou resp. v prípade skratu v obvode

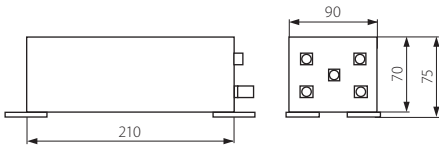

■ PERU 70



■ PERU 150

■ teleso: hliník

	<b>Kanlux</b>	<b>Kanlux</b>	EAN		In	[W]	[g]	DKC SK bez DPH
	PERU 70	04780	5905339047809	hliník	0,98A	70	1920	32,23 €
	PERU 150	04781	5905339047816	hliník	1,8A	150	2650	37,14 €



- zariadenie obsahuje kompenzáciu účinnikov
- slúži k napájaniu metalhalogenidových lebo vysokotlakých sodíkových výbojek (lebo svetiel, ktoré nemajú vlastný predradník, napr. PASAT)

Predradník

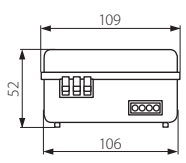
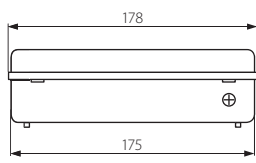
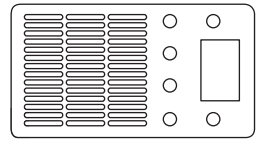

■ GB-2x26W

■ teleso: plast (PC)

		EAN 		DKC SK bez DPH
GB-2x26W	04376	5905339043764	šedá	14,64 €

■ zariadenie pre napájanie svietidiel typu DLP

## BS

Štartéry do žiaroviek



■ BS-1 4-22W



■ BS-2 4-65W

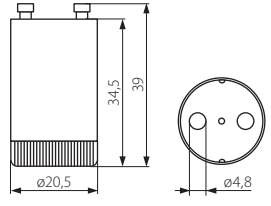

■ teleso: plast

		EAN 		Un		DKC SK bez DPH
BS-1 4-22W	07180	5905339071804	biela	230-240V~ - SERIES, 110-130V~ - SINGLE	4-22	0,33 €
BS-2 4-65W	07181	5905339071811	biela	230-240V~ - SINGLE	4-65	0,33 €

/100/3000	6	

■ BS-1 4-22W- možnosť použitia v obvodoch s priebežným zapojením žiaroviek napájaných z jedného predradníka 230/240V





MERGE JQ-L

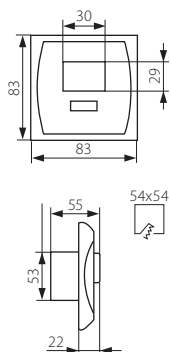

■ MERGE JQ-L

■ teleso: plast

NEW	<b>Kanlux</b>	<b>Kanlux</b>	EAN		DKC SK bez DPH						
	MERGE JQ-L	07690	5905339076908	biela	11,07 €						

- maximálny dosah čidla pohybu u MERGE JQ-L je 7m
- maximálny horizontálny uhol dosahu čidla pohybu u MERGE JQ-L je 120°
- možnosť nastavenia intervalu svietenia od 5s do 6min
- možnosť nastavenia stupňa intenzity osvetlenia okolia, pri ktorom zariadenie pracuje
- maximálny vertikálny uhol dosahu čidla pohybu u MARGE JQ-L je 60°
- u modelu MERGE JQ-L je rezistenčné zataženie max. 300W, impedančné zataženie je max. 100W



MERGE JQ-O

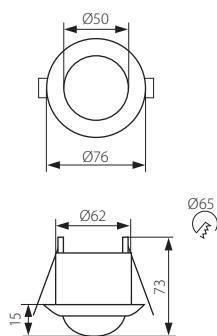

■ MERGE JQ-O

■ teleso: plast

NEW	<b>Kanlux</b>	<b>Kanlux</b>	EAN		DKC SK bez DPH					
	MERGE JQ-O	07691	5905339076915	biela	11,07 €					

- maximálny dosah čidla pohybu u MERGE JQ-O je to 5m v polomere
- maximálny horizontálny uhol dosahu čidla pohybu , u MERGE JQ-O je to 360°
- možnosť nastavenia intervalu svietenia od 5sek. do 6min.
- možnosť nastavenia úrovne osvetlenia, pri ktorom zariadenie pracuje
- maximálny vertikálny uhol dosahu čidla pohybu u MARGE JQ-O je 120°
- u modelu MERGE JQ-O je rezistenčné zataženie max. 2000W, impedančné zataženie je max. 600W

Pohybové čidlo



■ ALER JQ-30-W

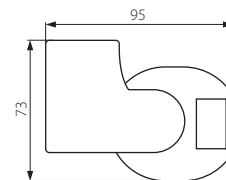

■ ALER JQ-30-B

■ teleso: plast

		EAN 		DKC SK bez DPH
ALER JQ-30-W	00460	5905339004604	biela	15,14 €
ALER JQ-30-B	00461	5905339004611	čierna	15,14 €

--	--	--	--	--	--	--	--	--	--

- maximálny dosah čidla 10m
- maximálny detekčný uhol čidla je 165°
- možnosť regulácie doby svietenia od 7s do 7min
- možnosť nastavenia úrovne osvetlenia, pri ktorom zariadenie pracuje

# ZONA JQ-37-W

Pohybové čidlo



■ ZONA JQ-37-W

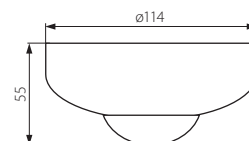

■ teleso: plast

		EAN 		DKC SK bez DPH
ZONA JQ-37-W	00464	5905339004642	biela	17,26 €

--	--	--	--	--	--	--	--	--

- maximálny dosah čidla 9m
- maximálny detekčný uhol čidla je 360°
- možnosť regulácie doby svietenia od 7s do 7min
- možnosť nastavenia úrovne osvetlenia, pri ktorom zariadenie pracuje

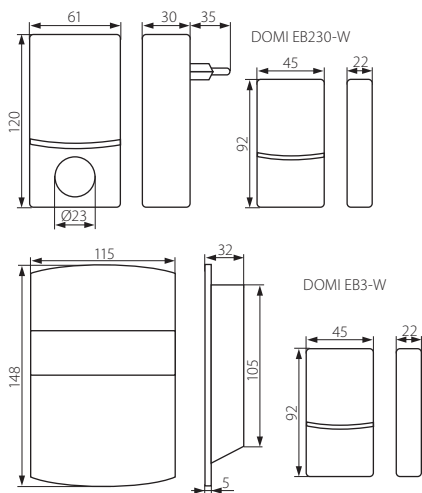

Bezdrôtový zvonček

teleso: plast

			EAN					DKC SK bez DPH
<b>NEW</b>	DOMI EB230-W	07882	5905339078827	biela	220-240V~	50/60Hz	150	25,23 €
<b>NEW</b>	DOMI EB3-W	07881	5905339078810	biela	2xAA		180	25,23 €



- počet melódii 32
- bateria súčasťou dodávky
- maximálna vzdalenosť medzi vysílačom a prijímačom je otvorenem priestore 100m
- zvonček určený pre vnútorné prostredie, tlačítko možno použiť vo vnútornom i vonkajšom prostredí
- DOMI EB230-W je v triede izolácie II, DOMI EB3-W je v triede izolácie III

## ELMA 6898

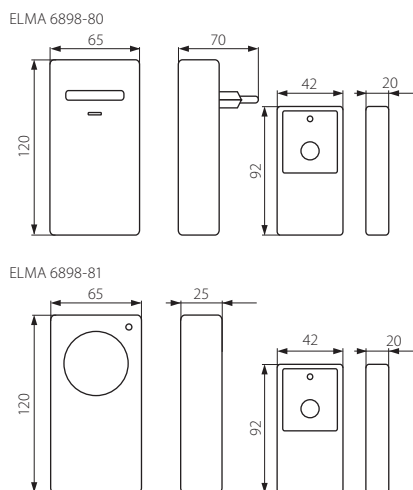

Bezdrôtový zvonček

teleso: plast

			EAN				DKC SK bez DPH
	ELMA 6898-80	00506	5905339005069	biela	250V~	190	12,91 €
	ELMA 6898-81	00505	5905339005052	biela	3xAA	150	10,75 €



- počet melódii 1
- bateria súčasťou dodávky
- maximálna vzdalenosť medzi vysílačom a prijímačom je v otvorenem priestore 60m pre ELMA 6898-80, a 80m pre ELMA 6898-81
- zvonček určený pre vnútorné prostredie, tlačítko možno použiť vo vnútornom i vonkajšom prostredí
- ELMA 6898-80 je v triede izolácie II, ELMA 6898-81 je v triede izolácie III

# CYBER TM-6

**Kanlux**

Elektronický časový spínač

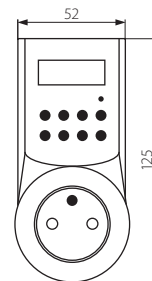

■ CYBER TM-6

■ teleso: plast

		EAN 		DKC SK bez DPH
CYBER TM-6	01016	5905339010162	biela	8,73 €

- obsahuje zdroj pre zalohovanie pamäti
- možnosť naprogramovania max. 8 zapnutí/vypnutí
- časový spínač pracuje v dennom a týždennom režime

# STER TS-MF1

Mechanický časový spínač

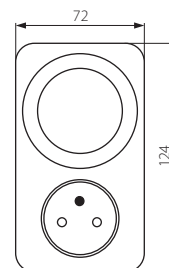

■ STER TS-MF1

■ teleso: plast

		EAN 		DKC SK bez DPH
STER TS-MF1	01001	5905339010018	biela	4,28 €

- minimálny čas zapnutia/vypnutia 15min
- časový spínač pracujúci v 24 hodinovom režime
- časový spínač vybavený funkciou stálého zapnutia

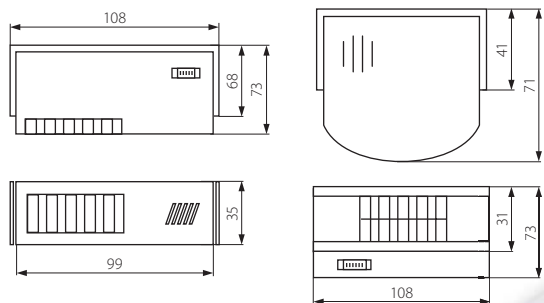

■ ROLO JQ-O



■ ROLO JQ-L

■ teleso: plast

Kanlux	Kanlux	EAN					DKC SK bez DPH
ROLO JQ-O	00465	5905339004659	biela	90	-	76	9,46 €
ROLO JQ-L	00466	5905339004666	biela	-	90	90	9,46 €



- maximálny dosah čidla 8m, slúži ku akustickej signalizácii pohybu v miestnosti
- možnosť prepnutia do režimu ALARM - doba signálu cca 20 sekund alebo do režimu GONG - doba signálu cca 3 sekundy

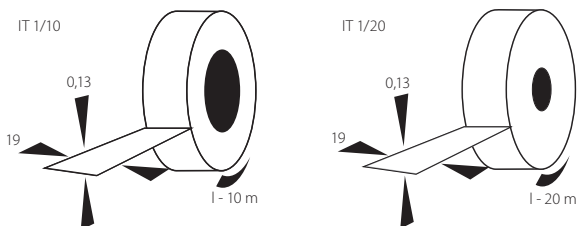

■ IT-1/10-BL

■ páska: plast

Kanlux	Kanlux	EAN			DKC SK bez DPH
IT-1/10-B	01257	5905339012579	čierna	1/10/500	40, 0,23 €
IT-1/10-Y	01258	5905339012586	žltá	1/10/500	40, 0,27 €
IT-1/10-RE	01259	5905339012593	červená	1/10/500	40, 0,27 €
IT-1/10-GN	01260	5905339012609	zelená	1/10/500	40, 0,27 €
IT-1/10-BL	01261	5905339012616	modrá	1/10/500	40, 0,27 €
IT-1/10-W	01262	5905339012623	biela	1/10/500	40, 0,27 €
IT-1/10-Y/GN	01263	5905339012630	žltozelená	1/10/500	40, 0,30 €
IT-1/20-B	01271	5905339012715	čierna	1/10/200	71, 0,46 €
IT-1/20-Y	01272	5905339012722	žltá	1/10/200	71, 0,50 €
IT-1/20-RE	01273	5905339012739	červená	1/10/200	71, 0,50 €
IT-1/20-GN	01274	5905339012746	zelená	1/10/200	71, 0,50 €
IT-1/20-BL	01275	5905339012753	modrá	1/10/200	71, 0,50 €
IT-1/20-W	01276	5905339012760	biela	1/10/200	71, 0,50 €
IT-1/20-Y/GN	01277	5905339012777	žltozelená	1/10/200	71, 0,50 €



■ ponúkané len ako skupinové balenie

Bezšróbová krabicová svorka



■ PC252/PA ■ PC253/PA ■ PC254/PA ■ PC255/PA

■ teleso: polyamid PA

Kanlux	Kanlux	EAN			[g]	DKC SK bez DPH
PC252/PA	02120	5905339506191	šedá	1/-/100	2	14,27 €
PC253/PA	02121	5905339506207	šedá	1/-/60	2	19,58 €
PC254/PA	02122	5905339506214	šedá	1/-/60	3	22,90 €
PC255/PA	02123	5905339506221	šedá	1/-/60	4	25,23 €

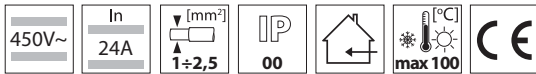

- PC252 je dvojdielová svorka, PC253 je trojdielová svorka, PC254 je štvordielová svorka, PC255 je pätdielová svorka
- svorka obsahuje merací bod pre zmeranie potenciálu
- cena jedného balenia
- ponúkané len ako skupinové balenie

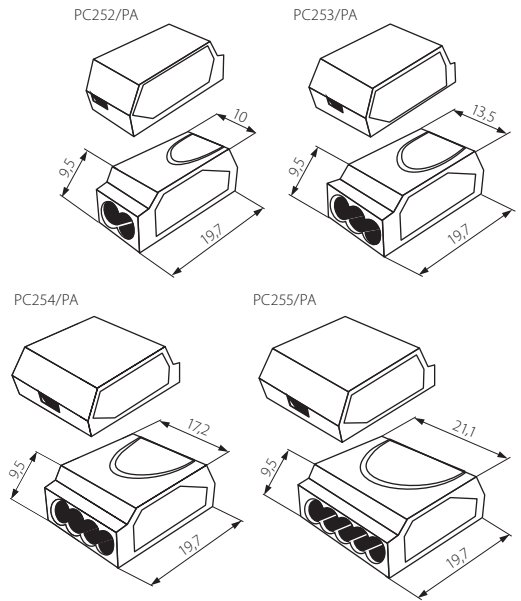

H

Svorkovnica dvanásťpólová

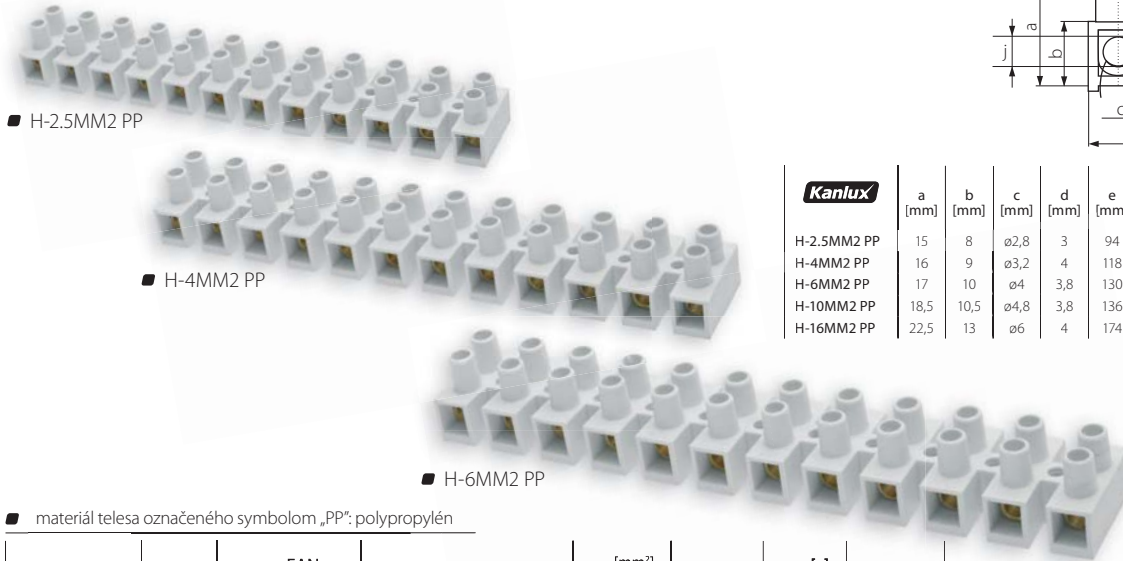

■ materiál telesa označeného symbolom „PP“: polypropylén

Kanlux	Kanlux	EAN		[mm²]		[g]	DKC SK bez DPH
H-2.5MM2 PP	02100	5905339505231	biela	1÷2,5	-/10/500	18	0,33 €
H-4MM2 PP	02101	5905339505248	biela	1,5÷4	-/10/500	28	0,43 €
H-6MM2 PP	02102	5905339505255	biela	2,5÷6	-/10/500	36	0,50 €
H-10MM2 PP	02103	5905339505279	biela	4÷10	-/10/500	51	0,76 €
H-16MM2 PP	02104	5905339505286	biela	6÷16	-/10/300	77	1,20 €



- maximální teplota okolia svorkovnic je 85 °C
- ponúkané len ako skupinové balenie

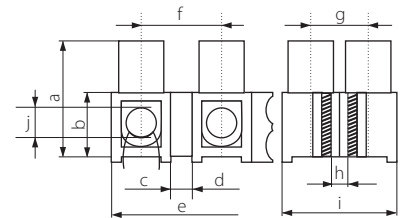

Kanlux	a [mm]	b [mm]	c [mm]	d [mm]	e [mm]	f [mm]	g [mm]	h [mm]	i [mm]	j [mm]
H-2.5MM2 PP	15	8	ø2,8	3	94	8	5,5	ø2	16,5	2,5
H-4MM2 PP	16	9	ø3,2	4	118	10	8	ø3	19,5	4
H-6MM2 PP	17	10	ø4	3,8	130	11	8	ø3,2	20,5	6
H-10MM2 PP	18,5	10,5	ø4,8	3,8	136	11,5	9,5	ø3,2	23	10
H-16MM2 PP	22,5	13	ø6	4	174	15	9,5	ø4	26	16

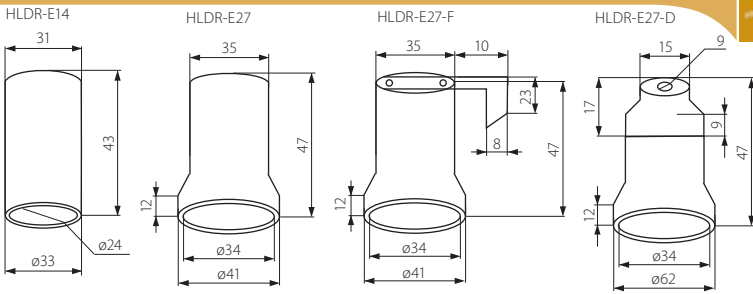

Keramická päťica

■ HLDR-E14



■ HLDR-E27-F

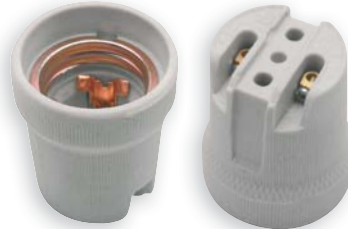

■ HLDR-E27

■ teleso: keramika

Kanlux	Kanlux	EAN					
HLDR-E14	02170	5905339021700	šedá	2A	E14	49	0,30 €
HLDR-E27	02160	5905339021601	šedá	4A	E27	67	0,30 €
HLDR-E27-F	02161	5905339021618	šedá	4A	E27	75	0,30 €
HLDR-E27-D	02162	5905339021625	šedá	4A	E27	73	0,30 €



DKC SK bez DPH

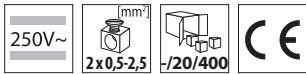

■ maximálna prípustná teplota päťice 180 °C

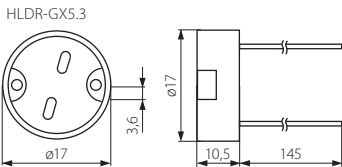
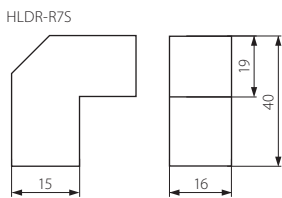
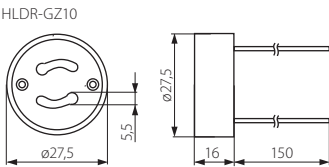

Keramická päťica



■ HLDR-GZ10



■ HLDR-R7S



■ HLDR-GX5.3

■ teleso: keramika

Kanlux	Kanlux	EAN							
HLDR-GZ10	00402	5905339004024	šedá	250V~	GU10/ GZ10	15cm, 2 x 0,75mm <sup>2</sup>	1/50/1000	19	0,53 €
HLDR-R7S	00405	5905339004055	šedá	250V~	R7s	25cm, 2 x 0,75mm <sup>2</sup>	-/10/500	17	0,30 €
HLDR-GX5.3	72109	5905339721099	šedá	24V	G4-GY6,35	15cm, 2 x 0,75mm <sup>2</sup>	-/100/2000	7	0,30 €

■ maximálny prúd HLDR-GZ10 je 2A, u HLDR-R7S je 6A u HLDR-GX5.3 je 5A

■ maximálna prípustná teplota päťice u HLDR-GZ10 je 250 °C



**Kanlux**



[www.kanlux.sk](http://www.kanlux.sk)

**Kanlux**



Náhradné diely





Pružinka upevňujúca svetelný zdroj v svietidle CT-21/MR11



<b>Kanlux</b>		DKC SK bez DPH
SPR.CT-21/MR11	72122	0,13 €



Pružinka upevňujúca svetelný zdroj v svietidle CT-21/MR16



<b>Kanlux</b>		DKC SK bez DPH
SPR.CT-21/MR16	72121	0,15 €



Pružinka upevňujúca svetelný zdroj v svietidle CTC-55/MR11



<b>Kanlux</b>		DKC SK bez DPH
SPR.CTC-55/MR11	72277	0,13 €



Pružinka upevňujúca svetelný zdroj v svietidle CTC-31/MR16 / svietidle CTC-55/MR16



<b>Kanlux</b>		DKC SK bez DPH
SPR.CTC-31/MR16	72279	0,15 €
SPR.CTC-55/MR16	72278	0,15 €

## MERA PP



**Kanlux**

Prepojovací kábel, slúži k priebežnému prepojeniu svietidiel MERA TL



**Kanlux**



DKC SK  
bez DPH

MERA PP

04733

0,67 €

## CONECT TL2004B-PP



Prepojovací kábel, slúži k priebežnému prepojeniu svietidiel GRELA TL2004

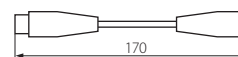

**Kanlux**



DKC SK  
bez DPH

CONECT TL2004B-PP

00525

0,78 €

## GL-HALI/CL+FR



Sklenené tienidlo k svietidlu HALI

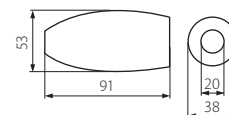

**Kanlux**



DKC SK  
bez DPH

GL-HALI/CL+FR

72352

1,42 €

## GL-ANO/CL+FR



Sklenené tienidlo k svietidlu ANO

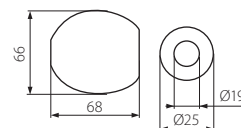

**Kanlux**



DKC SK  
bez DPH

GL-ANO/CL+FR

72351

1,42 €



**GL-GINA EL**

Sklenené tienidlo k sietidlu GINA EL

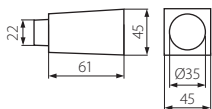

		DKC SK bez DPH
GL-GINA EL	72393	1,42 €



**GL-AMY EL**

Sklenené tienidlo k sietidlu AMY EL

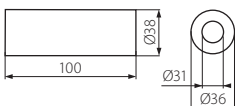

		DKC SK bez DPH
GL-AMY EL	72386	1,42 €



**GL-EDEN**

Sklenené tienidlo k sietidlu EDEN EL-25

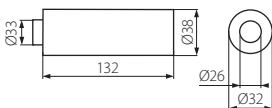

		DKC SK bez DPH
GL-EDEN	72382	2,57 €



**FSL F4 T5/BL**

Lineárna žiarivka k sietidlu MOSKITO T5

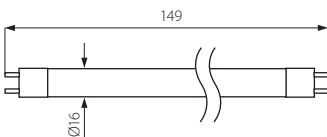

		DKC SK bez DPH
FSL F4 T5/BL	72359	2,57 €

## CLP-REGIS/PT



**Kanlux**

Montážny držiak, slúži k upevneniu svietidiel REGIS 418 do sádrokartonových podhlavov

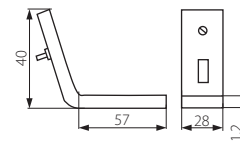

**Kanlux**



DKC SK  
bez DPH

CLP-REGIS/PT

72333

1,86 €

## CLP-VOLKER/PT



Montážny držiak, slúži k upevneniu svietidiel VOLKER 418 PT do sádrokartonových podhlavov

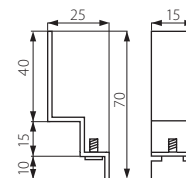

**Kanlux**



DKC SK  
bez DPH

CLP-VOLKER/PT

72383

1,86 €

## ROPE-NT 150



Ocelové lanko určené pre zavesenie rastrových, prachotesných a svietidiel OFRA TL

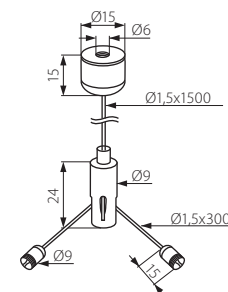

**Kanlux**



DKC SK  
bez DPH

ROPE-NT 150

07870

5,16 €

## COV-MEBA TL



Bočná krytka pre svietidla MEBA TL

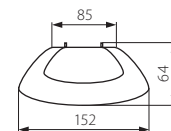

**Kanlux**



DKC SK  
bez DPH

COV-MEBA TL

72398

1,04 €



Mliečny difúzor k svetidlám MEBA TL-218/OP

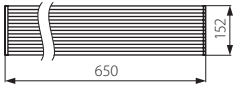

DKC SK  
bez DPH

GL-MEBA TL-218/OP

72396

4,15 €

Priehľadný difúzor k svetidlám MEBA TL-218

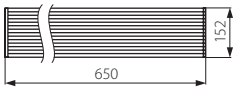

DKC SK  
bez DPH

GL-MEBA TL-218/PMMA

72391

4,15 €

Mliečny difúzor k svetidlám MEBA TL-236/OP

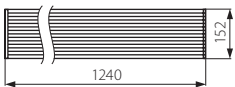

DKC SK  
bez DPH

GL-MEBA TL-236/OP

72397

4,15 €

Priehľadný difúzor k svetidlám MEBA TL-236

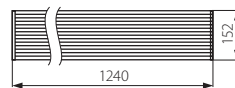

DKC SK  
bez DPH

GL-MEBA TL-236/PMMA

72392

4,15 €

## CL-MAH/A



**Kanlux**

Umelohmotná spona k svietidlám MAH/A

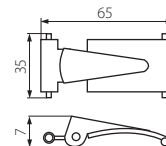

**Kanlux**

**Kanlux**

DKC SK  
bez DPH

CL-MAH/A

72304

0,78 €

## CL-MAH/A-INOX



Kovová spona k svietidlám MAH/A

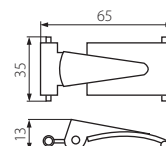

**Kanlux**

**Kanlux**

DKC SK  
bez DPH

CL-MAH/A-INOX

72308

0,78 €

## GL-MAH-1118/A-PC



PC difúzor k svietidlám MAH-1118/A-PC

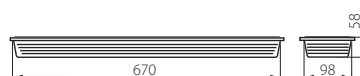

**Kanlux**

**Kanlux**

DKC SK  
bez DPH

GL-MAH-1118/A-PC

72280

2,83 €

## GL-MAH-1118/A-PS



PS difúzor k svietidlám MAH-1118/A-PS

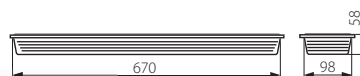

**Kanlux**

**Kanlux**

DKC SK  
bez DPH

GL-MAH-1118/A-PS

72362

2,02 €

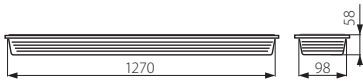

PC difúzor k svietidlám MAH-1136/A-PC

**Kanlux**DKC SK  
bez DPH

GL-MAH-1136/A-PC

72281

5,09 €

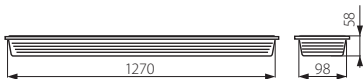

PS difúzor k svietidlám MAH-1136/A-PS

**Kanlux**DKC SK  
bez DPH

GL-MAH-1136/A-PS

72364

3,39 €

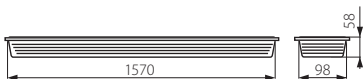

PC difúzor k svietidlám MAH-1158/A-PC

**Kanlux**DKC SK  
bez DPH

GL-MAH-1158/A-PC

72282

6,97 €



PS difúzor k svietidlám MAH-1158/A-PS

**Kanlux**DKC SK  
bez DPH

GL-MAH-1158/A-PS

72366

3,89 €

## GL-MAH-1218/A-PC



**Kanlux**

PC difúzor k svietidlám MAH-1218/A-PC

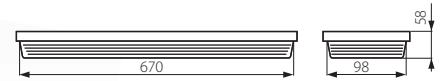

**Kanlux**

**Kanlux**

DKC SK  
bez DPH

GL-MAH-1218/A-PC

72283

3,86 €

## GL-MAH-1218/A-PS



PS difúzor k svietidlám MAH-1218/A-PS

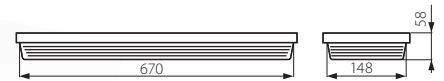

**Kanlux**

**Kanlux**

DKC SK  
bez DPH

GL-MAH-1218/A-PS

72363

2,57 €

## GL-MAH-1236/A-PC



PC difúzor k svietidlám MAH-1236/A-PC



**Kanlux**

**Kanlux**

DKC SK  
bez DPH

GL-MAH-1236/A-PC

72284

6,46 €

## GL-MAH-1236/A-PS



PS difúzor k svietidlám MAH-1236/A-PS

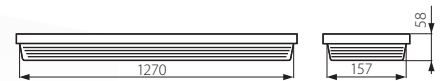

**Kanlux**

**Kanlux**

DKC SK  
bez DPH

GL-MAH-1236/A-PS

72365

3,89 €





## GL-MAH-1258/A-PC

PC difúzor k svietidlám MAH-1258/A-PC

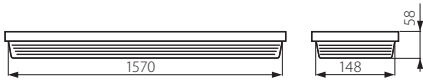

**Kanlux**



DKC SK  
bez DPH

GL-MAH-1258/A-PC

72285

7,52 €

## GL-MAH-1258/A-PS

PS difúzor k svietidlám MAH-1258/A-PS

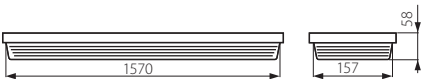

**Kanlux**



DKC SK  
bez DPH

GL-MAH-1258/A-PS

72367

5,57 €

## GL-S1101-W

Mliečny difúzor k svietidlám TUNA S1101

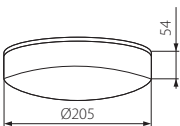

**Kanlux**



DKC SK  
bez DPH

GL-S1101-W

72309

1,29 €

## GL-PASAT 70

Ochranné sklo k svietidlu PASAT 70

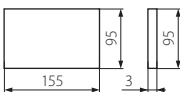

**Kanlux**



DKC SK  
bez DPH

GL-PASAT 70

72356

2,02 €

## GL-PASAT 150



**Kanlux**

Ochranné sklo k svietidlu PASAT 150

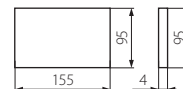

**Kanlux**

**Kanlux**

DKC SK  
bez DPH

GL-PASAT 150

72357

2,02 €

## GL-MATMA 70/150



Ochranné sklo k svietidlu MATMA MTH



**Kanlux**

**Kanlux**

DKC SK  
bez DPH

GL-MATMA 70/150

72368

2,57 €

## GL-MTH-473/150W



Ochranné sklo k metalhalogenidovým reflektorom FORT MTH

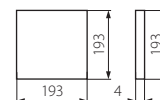

**Kanlux**

**Kanlux**

DKC SK  
bez DPH

GL-MTH-473/150W

72306

5,16 €

## GL-MTH-478/400W



Ochranné sklo k metalhalogenidovým reflektorom AVIA MTH

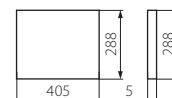

**Kanlux**

**Kanlux**

DKC SK  
bez DPH

GL-MTH-478/400W

72307

7,52 €



Ochranné sklo k svietidlu ADAMO MTH

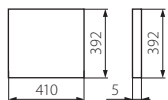

GL-ADAMO 250/400



72372

DKC SK  
bez DPH

9,07 €

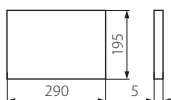

**GLASS-LOMA**

Ochranné sklo k halogenovým reflektorom LOMA 1000



GLASS-LOMA



72187

DKC SK  
bez DPH

2,57 €

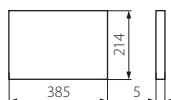

**GLASS-SALI**

Ochranné sklo k halogenovým reflektorom SALI 1500



GLASS-SALI



72186

DKC SK  
bez DPH

2,83 €

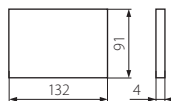

**GLASS-CE-81**

Ochranné sklo k halogenovým reflektorom rady CE-81



GLASS-CE-81



72159

DKC SK  
bez DPH

1,29 €

## GLASS-CE-81-Y



**Kanlux**

Ochranné sklo k oválným halogenovým reflektorom rady CE-81-Y

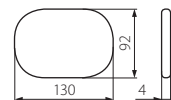

**Kanlux**



DKC SK  
bez DPH

GLASS-CE-81-Y

72160

1,29 €

## GLASS-CE-82



Ochranné sklo k halogenovým reflektorom rady CE-82

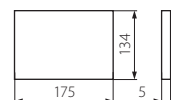

**Kanlux**



DKC SK  
bez DPH

GLASS-CE-82

72163

1,81 €

## GLASS-CE-82-Y



Ochranné sklo k oválným halogenovým reflektorom rady CE-82-Y

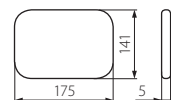

**Kanlux**



DKC SK  
bez DPH

GLASS-CE-82-Y

72164

1,81 €

## GLASS-SL-150R-F



Ochranné sklo k halogenovým reflektorom rady SL-150

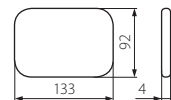

**Kanlux**



DKC SK  
bez DPH

GLASS-SL-150R-F

72165

1,29 €

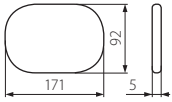

Ochranné sklo k halogenovým reflektorom rady SL-300



		DKC SK bez DPH
GLASS-SL-300R-F	72166	1,81 €

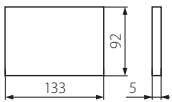

Ochranné sklo k halogenovým reflektorom TRAP ZW3-L150



		DKC SK bez DPH
GLASS-ZW3-L150	72126	1,29 €

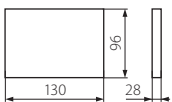

Ochranná mriežka k halogenovým reflektorom TRAP ZW3-L150

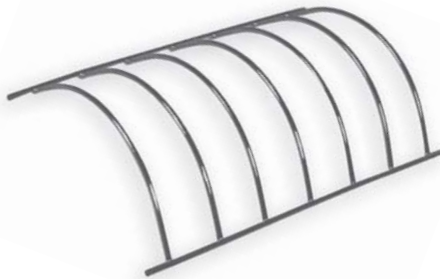

		DKC SK bez DPH
GRID-ZW3-L150	72114	1,29 €



Ochranná mriežka k halogenovým reflektorom ELIOT ZW3-L500



		DKC SK bez DPH
GRID-ZW3-L500	72115	1,81 €

**IP** Vysvetlenie stupňa ochrany pred vniknutím pevných predmetov a vody

Stupeň ochrany pred neúmyselným kontaktom s časťami pod napätím			
IP	Obrázok	Popis	Vysvetlenie
0		Bez ochrany	Žiadna zvláštna ochrana
1		Ochrana proti telesám s priemerom väčším ako 50mm	Veľký povrch telesa, napr. ruka (nakolko ochrana proti úmyselnému dotyku) Pevné predmety s priemerom väčším ako 50mm
2		Ochrana proti telesám s priemerom väčším ako 12mm	Prsty alebo predmety nepresahujúce dĺžku 80mm. Pevné predmety s priemerom väčším ako 12mm
3		Ochrana proti telesám s priemerom väčším ako 2,5mm	Nástroje, dróty a pod. s priemerom alebo hrúbke väčšej ako 2,5mm
4		Ochrana proti telesám s priemerom väčším ako 1mm	Drot alebo pás silnejší ako 1mm
5		Ochrana proti prachu	Vnikanie prachu nie je celkom zabránené, ale prach nemôže vniknúť v takom množstve, aby bránil riadnej funkcii zariadenia
6		Prachotesné	Nedochádza k vnikaniu prachu

Stupeň ochrany pred vniknutím vody			
IP	Obrázok	Popis	Vysvetlenie
0		Bez ochrany	Žiadna zvláštna ochrana
1		Ochrana proti kvapkajúcej vode	Zvisle padajúce kvapky nesmú mať škodlivý účinok na zariadenie
2		Chránené proti kvapkajúcej vode pri naklonení 15°	Zvisle kvapkajúca voda nesmie mať škodlivý účinok, ak je kryt naklonený až do 15° zo svojej normálnej polohy
3		Ochrana proti rozpráanej vode	Voda padajúca v rozpráanej forme v uhle až do 60° od zvislice nesmie mať škodlivý účinok
4		Ochrana proti striekajúcej vode	Voda striekajúca na kryt zo všetkých smerov nesmie mať škodlivý účinok
5		Ochrana proti tryskajúcej vode	Voda striekajúca z trysiek z ľubovoľného smeru nesmie mať škodlivý účinok
6		Ochrana proti intenzívne tryskajúcej vode	Voda striekajúca z trysiek z ľubovoľného smeru nesmie mať škodlivý účinok
7		Ochrana proti účinkom dočasného ponorenia do vody	Ponorenie zariadenia do vody pri stanovenom tlaku a po stanovenú dobu nesmie preniknúť dovnútra zariadenia v takom množstve, aby mala škodlivý účinok
8		Ochrana proti účinkom trvalého ponorenia do vody	Zariadenie je vhodné pre trvalé ponorenie do vody za podmienok, ktoré určí výrobca

Označenie ochrany pred vzplanutím

Symbol	Vysvetlenie
Nedostatok	Určené k montáži na nehorľavé povrchy (kameň, betón).
	Určené k montáži na normálne horľavé povrchy. Teplota vzplanutia materiálov vyšších ako 200 °C.
	Určené k montáži na ľahko zápalné povrchy. Teplota vzplanutia materiálu nižšia ako 200 °C.

Ochrana pred úrazom elektrickým prúdom

Trieda bezpečnosti	Symbol	Vysvetlenie
0	Nedostatok	Ochrana pred úrazom elektrickým prúdom je založená na základnej izolácii. Ochrana pred úrazom elektrickým prúdom je zaistená okolím a tiež polohou zariadenia.
I		U zariadení triedy ochrany I je ochrana pred úrazom elektrickým prúdom zaistená pripojením neživých častí k ochrannému vodiču.
II		Zariadenie triedy ochrany II nemajú prostriedky pre pripojenie ochranného vodiča, sú vybavené prídavnou alebo zosilnenou izoláciou.
III		Ochrana pred úrazom elektrickým prúdom zariadenia triedy ochrany III je založená na napájaní bezpečným malým napätím.

Trieda energetickej účinnosti

Trieda energetickej účinnosti sa udáva pri laboratórnych skúškach, zhodne s príslušnými predpismi. Triedou A sa označujú zariadenia najviac účinné, triedou G najmenej účinné. Nižšie uvedená tabuľka ukazuje, aký maximálny príkon môžu prijať vzorové svetelné zdroje, majúce patričný svetelný tok, aby ich bolo možno označiť patričnou triedou energetickej účinnosti.

Svetelný tok [lm]	Trieda A	Trieda B	Trieda C	Trieda D	Trieda E	Trieda F
90	3,2	7,66	10,21	12,12	14,03	16,59
150	4,48	10,88	14,5	17,22	19,94	23,57
200	5,45	13,35	17,8	21,13	24,47	28,92
250	6,37	15,7	20,93	24,86	28,78	34,01
300	7,25	17,97	23,95	28,44	32,94	38,92
350	8,09	20,17	26,89	31,93	36,97	43,7
400	8,92	22,32	29,76	35,34	40,92	48,36
420	9,24	23,17	30,89	36,68	42,48	50,2
450	9,73	24,43	32,57	38,68	44,79	52,93
500	10,52	26,51	35,34	41,97	48,6	57,43
550	11,29	28,55	38,07	45,21	52,35	61,86
600	12,06	30,57	40,76	48,41	56,05	66,24
650	12,81	32,57	43,43	51,57	59,71	70,57
700	13,56	34,55	46,07	54,7	63,34	74,86
710	13,71	34,94	46,59	55,33	64,06	75,71
750	14,3	36,51	48,68	57,81	66,93	79,1
800	15,03	38,45	51,27	60,89	70,5	83,32
850	15,75	40,38	53,84	63,94	74,04	87,5
900	16,47	42,3	56,4	66,98	77,55	91,65
950	17,18	44,2	58,94	69,99	81,04	95,78
1000	17,89	46,1	61,46	72,99	84,51	99,88
1050	18,59	47,98	63,97	75,97	87,96	103,95
1100	19,29	49,85	66,47	78,93	91,39	108,01
1150	19,98	51,72	68,95	81,88	94,81	112,05
1200	20,67	53,57	71,43	84,82	98,21	116,07
1300	22,04	57,26	76,34	90,66	104,97	124,06
1400	23,4	60,92	81,22	96,45	111,68	131,98
1600	26,08	68,16	90,88	107,92	124,96	147,68
1700	27,41	71,75	95,67	113,6	131,54	155,46
1750	28,06	73,54	98,05	116,43	134,82	159,33
1800	28,72	75,32	100,43	119,26	138,09	163,2
1850	29,38	77,1	102,8	122,08	141,35	167,05
2000	31,33	82,41	109,88	130,49	151,09	178,56
2300	35,2	92,94	123,92	147,16	170,39	201,37
2400	36,48	96,43	128,57	152,68	176,78	208,92
2600	39,02	103,36	137,82	163,66	189,5	223,95
3040	44,54	118,49	157,98	187,61	217,23	256,72



## Teplota chromatičnosti

Teplota chromatičnosti Tc [K] sa rovná teplote čierneho žiaríča, ktorého žiarenie má takú chromatičnosť ako uvažované žiarenie. Inými slovami sa jedná o objektívnu mieru farby daného svetelného zdroja.

<2700K	Farba žltá-biela	8000-10000K	Azurovo - jasné nebo v zime napoludnie
2700K-3500K	Farba tepla-biela (WW)	20000K	Azurovo - jasné nebo v lete napoludnie
3500K-5000K	Farba biela (neutrálna)	28000-30000K	Teplota výboja blesku
5000K-6500K	Farba denná (studená biela) (CW)		

## Porovnanie svetelných tokov úsporných žiaroviek a klasických žiaroviek

	5W	7W	9W	11W	13W	15W	18W	20W	23W	24W	26W
	25W	35W	45W	55W	65W	75W	90W	100W	115W	120W	130W

## Najčastejší používaný druh päťíc:

päťice závitové	 <b>E40</b>	 <b>E27</b>	 <b>E14</b>	Päťica je časť svetelného zdroja, ktorá slúži k jeho upevneniu v svietidle, a tiež slúži k pripojeniu svetelného zdroja k elektrickému obvodu. Druh päťice je obvykle označovaný jedným, alebo viacerými písmenami, alebo číslom určujúcim približný rozmer päťice v milimetroch (prevážne priemer, alebo roztoč hrotov).							
päťice svetelných zdrojov malého napätia	 <b>GY6.35</b>	 <b>Gx5,3</b>	 <b>G4</b>	 <b>G53</b>	 <b>G6,35</b>	 <b>GU4</b>	 <b>GU5,3</b>				
päťice svetelných zdrojov nízkeho napätia	 <b>G24d</b>	 <b>G23</b>	 <b>G9</b>	 <b>GU10</b>	 <b>GZ10</b>	 <b>GR8</b>	 <b>G12</b>				
štvorpinové päťice	 <b>2G7</b>	 <b>GR10q</b>	 <b>G10q</b>								
päťice svetelných zdrojov s dvoma koncami (lineárne halogénové žiarovky, halogenidové výbojky)	 <b>R7s</b>	 <b>RX-7s</b>	 <b>G5</b>	 <b>G13</b>							

## Napájanie svetelných zdrojov LED a halogénových žiaroviek

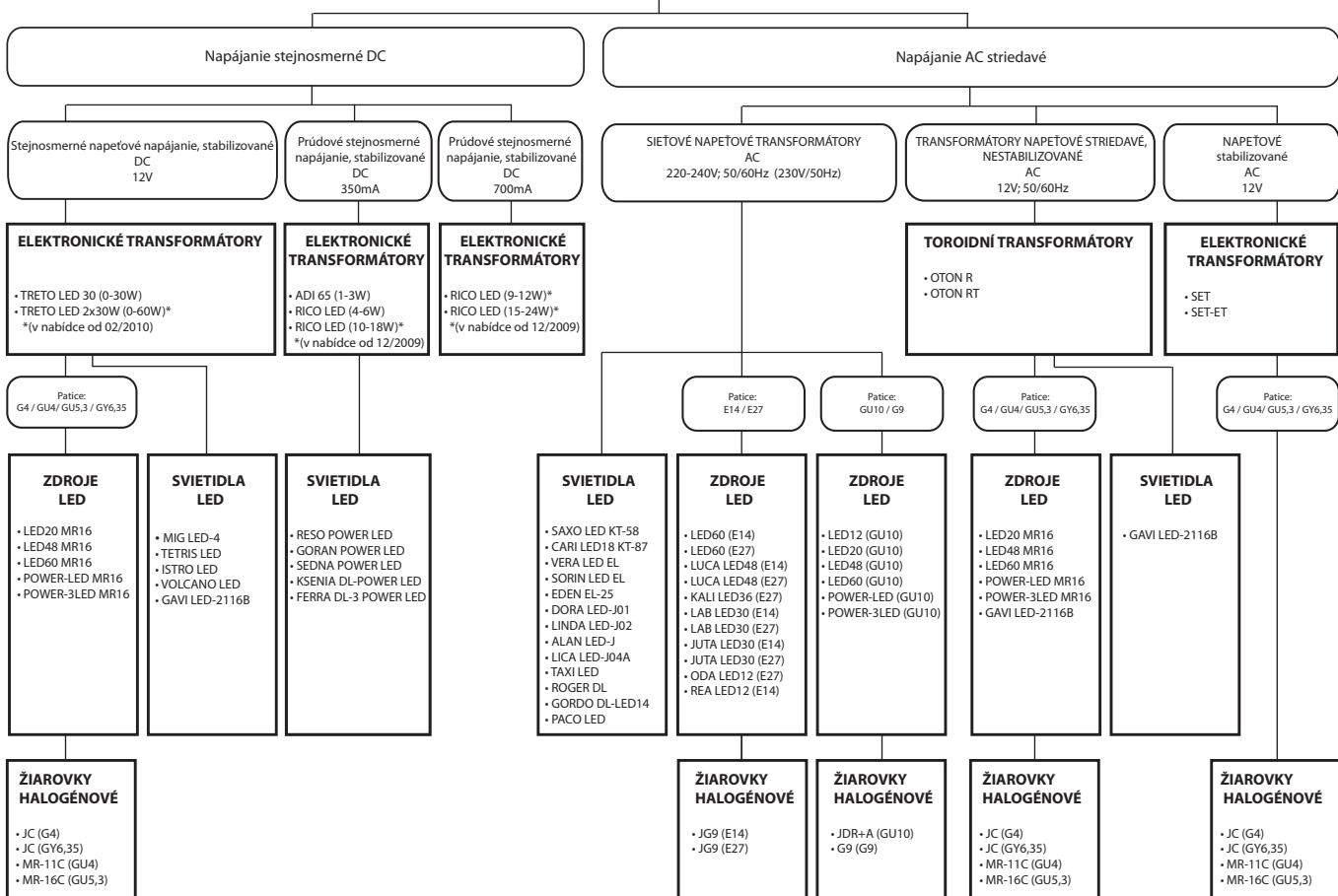

<b>NEW</b>	novinka
	dodávky
	rozмеры montážneho otvoru
<b>Kanlux</b>	názov výrobku
	kód Kanlux
<b>EAN</b>	čiarový kód EAN
	čiarový kód EAN
	farba
	farba prepínača
	napájanie, napr.
	12V, 230V~, 250V~, 220-240V~
	menovité napätie (Un), napr.
	Un 230/400V~, 230V~, 400V~
	maximálna hodnota pracovného napätia, napr.
	U <sub>c</sub> (V) <450
	menovitý prúd (In), napr.
	In 13mA, 24A/PCU, max 63A
	príkon, napr.
	100, 2 x 60, max 500
	účinník (cosφ), napr.
	PF(A) 0,98
<b>PRI</b>	vstupné napätie (PRI)
<b>SEC</b>	výstupné napätie (SEC)
	menovitý reziduálny prúd (IΔn), napr.
	IΔn 0,03A
	menovitý kmitočet, napr.
	50Hz, 50/60Hz
	menovitý skratový prúd (Icn), napr.
	Icn 3000A, 6000A
	vypínacia charakteristika, napr.
	B, C
	druh predradníka, napr.
	<b>EVG</b> elektronický
	<b>VVG</b> indukčný
	druh zdroja svetla
	COMPACT, DD, T1U, T2U, T4, T5, T8, PZ 4T5/BL, R39, R50, N63, J-78mm, J-118mm, J-189mm, J-254mm, G9, JDR, JC, MR-11, MR-16, METALHALIDE, METALHALIDE, LED, POWER LED, BALTA, NEON, COMPACT, AR-111
	pätica
	E40, E27, E14, R7s, G9, GU10, G16/G21, GY6.35, GX6.35, G5,3, GX5,3, G4, GU4, GU5,3, G53, GX4, G5, G12, G13, G23, G24d, RX-7s, GR8, G10q, GR10q, GX53

	farba svetla
	teplota chromatičnosti (Tc), napr.
	2700, 3500, 4000
<b>[cd]</b>	maximálna svetivosť
	svetelný tok
	výžarovací uhol, napr.
	30, 45
	index reprodukcie farieb (Ra), napr.
	70, ≥80
<b>Ei</b>	trieda energetickej účinnosti (Ei), napr.
	A<E, B<E, A2<E, B2<E, EEE=A2
	životnosť svetelného zdroja, napr.
	1500, 2000, 8000
	nevhodné pre použitie so stmievačom
	s vypínačom
	s ťahovým vypínačom
	s časovým vypínačom
	montáž, napr.
	k montáži na stenu
	k montáži do steny
	k prísazeni ke stropu
	k zabudovaniu do stropu
	k zabudovaniu do podkladu
	k zabudovaniu do stropu alebo steny
	určené k montáži na lištu DIN 35mm
	pevné svetidlo
	svetidlo nastaviteľné v horizontálnom smere, napr.
	60, 90, 320
	svetidlo nastaviteľné vo vertikálnom smere, napr.
	15, 90, 130
	svetidlo nastaviteľné vo všetkých smeroch
	druh a parametre prípojky, napr.
	svorka
	odľahčovací svorka
	pružinové klipsy
	prívod s vidlicou
	svetidlo s prívodom
	prívod

	stálosť spojenia, napr.
	4000, 10000, 100000
	prierez prívodu, napr.
	2 x 0,75, 2 x 1,0, 3 x 1,0
	minimálna vzdialenosť od osvetľovaného predmetu, napr.
	0,5, 1,0, 2,0
	stupeň krytia (IP), napr.
	IP 20, IP 44/20, IP 65
	stupeň mechanickej ochrany, napr.
	IK <sup>[1]</sup> IK 06, IK 09, IK 10
	odolnosť voči statickému zaťaženiu, napr.
	20(kN)
	k vnútornému použitiu
	k vonkajšiemu alebo vnútornému použitiu
	maximálna teplota okolia, napr.
	max 40, -5-40, -25-55
	trieda ochrany pred úrazom elektrickým prúdom
	prvá
	druhá
	tretia
	k montáži na normálne horľavom povrchu
	počet modulov, napr.
	1P, 3P, 4P
	počet polí
	váha, napr.
	36, 254, 600
	balení jednotne/ skupinovo/ hromadne, napr.
	1/-/20, /-/10/200
	určený svetelný zdroj
	určene napájanie
	znaky zhody
	certifikát bezpečnosti
	certifikát Sercoc
	zhoda s európskymi normami (CE)
	CE

Tento katalóg bol pripravený spoločnosťou Kanlux s.r.o. Pre nepretržité vylepšovanie svojej ponuky v zhode s právnymi požiadavkami a požiadavkami na trhu si spoločnosť Kanlux s.r.o. si vyhradzuje právo zmien sortimentu a taktiež cien. Tento katalóg nie je ponukou v zmysle občianskeho práva. Reálne výrobky sa môžu odlišovať od výrobkov uvádzaných v tomto katalógu. Všetky údaje v katalógu sú platné ku dňu jeho vydania, t.j. 10. decembra 2009. Kanlux s.r.o. nenesie žiadnu zodpovednosť za nedostupnosť produktov uvádzaných v katalógu. Kanlux s.r.o. taktiež nenesie žiadnu zodpovednosť za akékoľvek okamžité, následné ani iné škody (tiež ušlý zisk, stratu príjmov, alebo iné ekonomické straty) vzniknuté z dôvodu využitia informácií uvedených v tomto katalógu. Všetky ceny, ktoré sú uvedené v katalógu sú bez DPH a bez recyklačného poplatku.